

Rhinologie Instrumentarium

Rhinology Instruments



Quality you can rely on

30
Years
SPIGGLE & THEIS
1994 - 2024





Über uns

About Us

Herzlich willkommen in unserem Instrumentenkatalog.

Bevor Sie in die Welt unserer ‚MADE IN GERMANY‘ Instrumente eintauchen, möchten wir Ihnen einen kurzen Einblick in unsere Erfolgsgeschichte gewähren.

Was vor 30 Jahren als überschaubares Handelsunternehmen begann, hat sich seitdem zu einem weltweit etablierten Hersteller erstklassiger **HNO-Instrumente und Verbrauchsmaterialien** entwickelt.

Unsere Geschichte ist geprägt von einer tiefen Hingabe zur Hals-, Nasen- und Ohrenchirurgie sowie von kontinuierlicher Weiterentwicklung. **Unsere Leidenschaft** zur HNO spiegelt sich wider in der Partnerschaft mit den medizinischen Fachkräften, die ein integraler Bestandteil unseres Netzwerks und unserer Innovationskraft sind.

Einen weiteren Schlüssel unseres Erfolges stellen **unsere Mitarbeiter** dar, von denen einige bereits seit Jahrzehnten Teil unseres Unternehmens sind. Ihre Fachkompetenz und kontinuierlicher Einsatz haben es uns ermöglicht, zusammen mit Ihnen neue Produkte zu entwickeln und fortlaufend zu verbessern.

2020 ist die **SPIGGLE & THEIS Medizintechnik GmbH** mehrheitlich von der **Thyssen'schen Handelsgesellschaft** übernommen worden, wodurch der weitere Ausbau des Unternehmens, unter Berücksichtigung unserer Innovationskraft und des Qualitätsversprechens, sichergestellt ist. Mit diesem starken Partner an unserer Seite eröffnen sich neue Horizonte, die uns unsere Visionen schneller umsetzen lassen und den Kundenanforderungen noch besser gerecht werden.

Dieser Katalog präsentiert **hochwertige Instrumente**, die auf den Bedürfnissen unserer Kunden und Partner aus der HNO-Medizin basieren. Wir hoffen, dass Sie unser Produktportfolio überzeugt und Sie hier das passende Instrument für Ihre Anforderung finden.

Wir danken Ihnen herzlich für Ihre **Treue** und Ihr **Vertrauen**.

Ihr SPIGGLE & THEIS Team

Welcome to our instrument catalog.

Before you immerse yourself in the world of our ‚MADE IN GERMANY‘ instruments, allow us to offer a brief glimpse into our success story.

What began as a modest trading company three decades ago has since developed into a globally recognized manufacturer of top-tier **ENT instruments and consumables**.

Our history is defined by a profound dedication to ENT surgery, healing practices, and continuous growth. **Our passion** resonates perfectly with the physicians, specialists, and medical professionals who are integral to our network and innovative spirit.

Another vital aspect of our success is **our employees**, some of whom have been with our company for decades. Their expertise and unwavering dedication have empowered us to collaborate with you in developing and consistently enhancing new products.

In 2020, **SPIGGLE & THEIS Medizintechnik GmbH** was primarily acquired by **Thyssen'sche Handelsgesellschaft**, ensuring the company's continued expansion while prioritizing our innovative capacity and commitment to quality. With this robust partnership at our side, new horizons have emerged, accelerating the realization of our visions and enhancing our ability to meet customer demands more efficiently.

This catalog showcases **premium instruments** tailored to the needs of our clients and partners in the field of ENT medicine. We hope you discover the perfect instrument that meets your requirements and allows our commitment to quality to speak for itself.

Thank you very much for your **loyalty** and **trust**.

Your SPIGGLE & THEIS Team



Inhaltsverzeichnis

Table of contents

01	Endoskopie / Endoscopy	5 - 9
02	Nasenspekula / Nasal Specula	10 - 13
03	Untersuchungsinstrumente / Examination Instruments	14 - 18
04	Nasenzangen/Nasenscheren / Nasal Forceps/Nasal Scissors	19 - 28
05	Elevatorien/Raspatorien / Elevators/Raspatories.....	29 - 32
06	Meißel/Osteotome/Hämmer / Chisels/Osteotomes/Mallets	33 - 39
07	Messer / Knives.....	40 - 41
08	Wundhaken / Retractors.....	42 - 45
09	Scheren / Scissors.....	46 - 57
10	Pinzetten/Nadelhalter / Forceps/Needle Holders	58 - 62
11	Raspeln / Rasps	63 - 66
12	Allgemeines / Miscellaneous	67 - 72
13	Sterilisationssysteme / Sterilizing Systems.....	73 - 74
14	Sets	75 - 77
	Index.....	78 - 81
	Umrechnungstabelle / Conversation table.....	82

Attention:

Not every instrument is available in all markets. Availability depends on local regulations. Please contact your SPIGGLE & THEIS representative or distributor, if you have any questions about the availability of our products in your region.

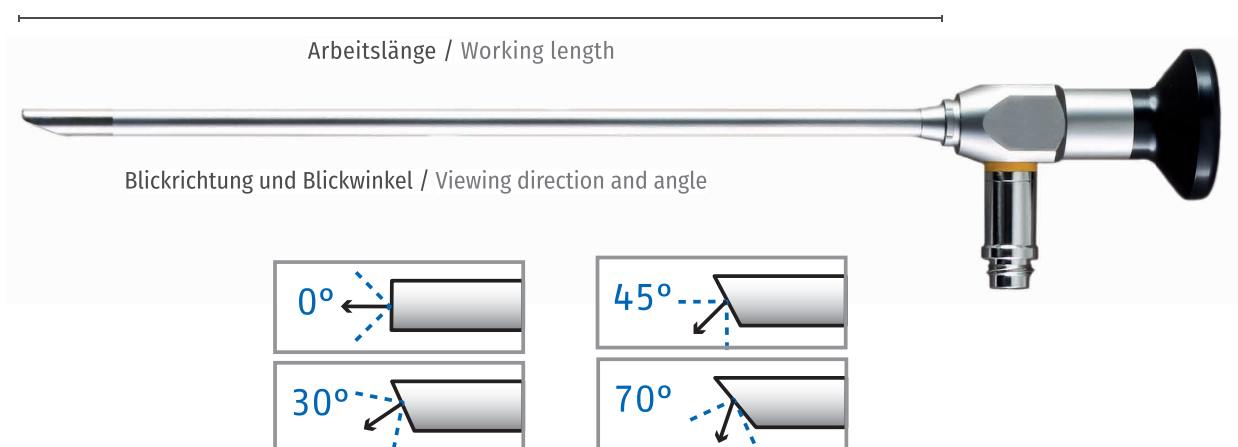

Vorteile unserer Endoskope:

- Kompatibel mit allen Lichtquellen auf dem Markt (universalkompatibel)
- Extrem robuste Rohrkonstruktion mit verstärktem 2-Rohr-Edelstahl-System
- Hochwertig vergütetes, hochauflösendes Linsen-System
- Optische Saphirglas-Frontlinse, kratzfest und hitzebeständig fixiert mit Epoxidharz
- Hitzebeständiges Polymer-Okular (PEEK)
- Hohe Dichtigkeit durch gelaserte Schnittstellen
- Mehr Bildinformation durch großen Öffnungswinkel
- Hohe Bildschärfe im gesamten Bildbereich
- Gleichmäßige Helligkeit bis zum Rand durch Lichtkonus
- Autoklavierbar
- 24 Monate Garantie

Advantages of our endoscopes:

- Compatible to all light sources available (universal camera compatible)
- Extremely robust stainless steel tube construction with reinforced outer tube
- High precision quality lens system
- Optical sapphire glass front lens, scratch resistant and fixed with heat-resistant epoxide
- Heat-resistant polymer ocular (PEEK)
- Tight sealing due to laser welded joints
- More image information due to wide viewing angle
- High focus quality in entire viewing area
- Constant brightness up to the edge of viewing area
- Autoclavable
- 24 months guarantee

Auch als
semiflex-Endoskope
erhältlich

Also available as
semiflex endoscopes



All unsere Endoskope sind aus Phynoxstahl
verbesserter Schutz gegen Verbiegen und Bruch

All our endoscopes are made of phynox steel
for improved protection against bending or breaking

01 Endoskopie

Endoscopy

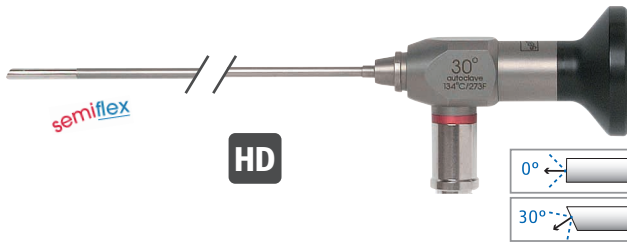

Sinuskop, HD, semiflex, autoklavierbar, AD 2,7 mm, 11 cm
Sinuscope, HD, semiflex, autoclavable, OD 2.7 mm, 11 cm

Art.-Nr./No.	Winkel / Angle
30-135-00	0°
30-135-30	30°

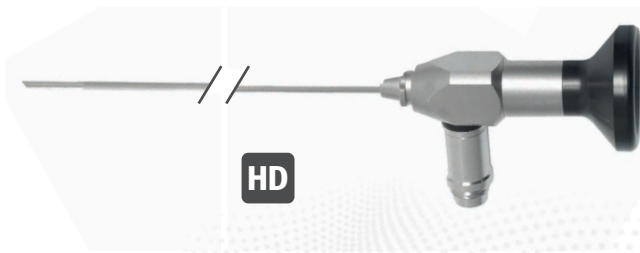

Sinuskop HD, starr, autoklavierbar, AD 4,0 mm, 17,5 cm
Sinuscope, HD, rigid, autoclavable, OD 4.0 mm, 17.5 cm

Art.-Nr./No.	Winkel / Angle
30-142-45	45°
30-142-90	90°

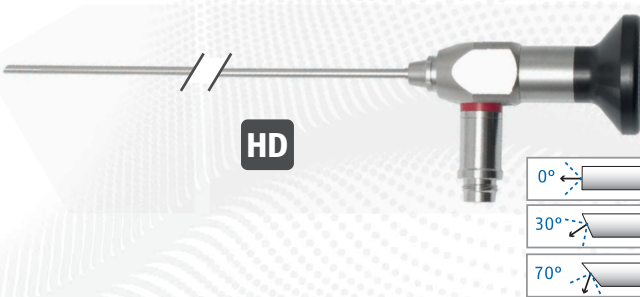

Sinuskop, HD, starr, autoklavierbar, AD 2,7 mm, 18,75 cm
Sinuscope, HD, rigid, autoclavable, OD 2.7 mm, 18.75 cm

Art.-Nr./No.	Winkel / Angle
30-130-00	0°
30-130-30	30°
30-130-70	70°

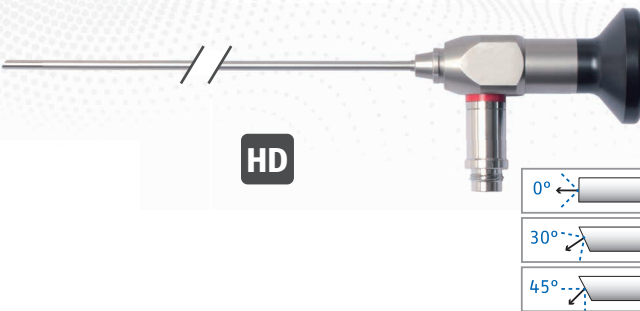

Sinuskop, HD, starr, autoklavierbar, AD 2,7 mm, 14,1 cm
Sinuscope, HD, rigid, autoclavable, OD 2.7 mm, 14.1 cm

Art.-Nr./No.	Winkel / Angle
30-132-00	0°
30-132-30	30°
30-132-45	45°

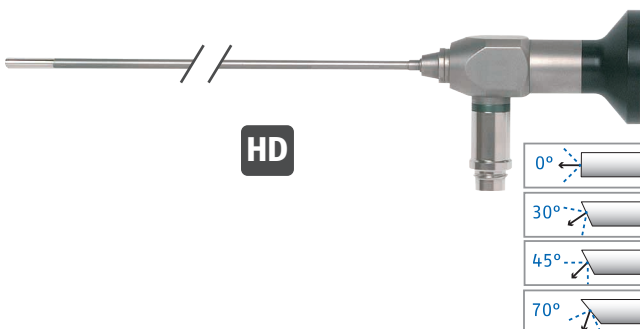

Sinuskop, HD, starr, autoklavierbar, AD 2,7 mm, 11 cm
Sinuscope, HD, rigid, autoclavable, OD 2.7 mm, 11 cm

Art.-Nr./No.	Winkel / Angle
30-134-00	0°
30-134-30	30°
30-134-45	45°
30-134-70	70°



**Ultra-Stop Antibeschlagmittel
Ultra-Stop Anti-Fog solution**

Art.-Nr./No.	Beschreibung / Description
30-160-01	25 ml Pipettenflasche, unsteril 25 ml pipette bottle, non-sterile
30-160-02	30 ml Durchstichflasche, steril 30 ml pierce bottle, sterile
30-160-03	15 ml Sprayflasche, unsteril 15 ml spray bottle, non-sterile



**Anti-Fog Antibeschlag-Satz, steril, 48 Stück/Box
Anti-Fog solution kit, sterile, 48 pieces/box**

30-160-05



**Dichtigkeitstester für flexible Endoskope
Leak tester for flexible endoscopes**

30-169-08





LED-Leuchtgriffe / LED light handles

Art.-Nr./No.

- | | |
|-----------|--|
| 70-211-00 | LED-Hochleistungs-Leuchtgriff, 230 V, bestehend aus: (70-211-10, 70-211-20, 70-211-30, 70-211-40)
LED high performance light-handle, 230 V, consisting of: (70-211-10, 70-211-20, 70-211-30, 70-211-40) |
| 70-211-01 | LED-Hochleistungs-Leuchtgriff, 120 V, bestehend aus: (70-211-10, 70-211-20, 70-211-30, 70-211-50)
LED high performance light-handle, 120 V, consisting of: (70-211-10, 70-211-20, 70-211-30, 70-211-50) |
| 70-211-10 | LED-Handgriff, schwarz, mit Helligkeitsdimmer, Ausschaltautomatik, 3 W, 5500 °K, 17500 Lux, zur Verwendung mit Li-Io-Akku 3,7 V und Endoskop-Adapter, 50 Std. Brenndauer
LED light handle, black, with brightness dimmer, automatic switch-off, 3 W, 5500 °K, 17500 lux, to use with Li-ion chargeable battery 3.7 V and endoscope adapter, 50 hours run-time |
| 70-211-20 | Li-Ionen-Akku, 3,7 V, für LED-Handgriff
Li-ion rechargeable battery, 3.7 V, for LED light-handle |
| 70-211-30 | Endoskopie-Adapter für LED-Handgriff, passend für Standardgewinde an Endoskopen (AcMI-Gewinde)
Endoscope adapter for LED light-handle, fits standard endoscope threads (AcMi-thread) |
| 70-211-40 | Ladegerät für bis zu 2 LED-Handgriffe, 3,5 V, 230 V, Standgerät, mit Wandhalterung
Charging base for up to 2 LED light-handles, 3.5 V, 230 V, table model, with wall holder |
| 70-211-50 | Ladegerät für bis zu 2 LED-Handgriffe, 3,5 V, 120 V, Standgerät, Wandhalterung
Charging base for up to 2 LED light-handles, 3.5 V, 120 V, table model, with wall holder |

Arbeitslänge	32 cm
Working length	32 cm
Abwinkelung (auf / ab)	130°
Angle (up / down)	130°
Biegeradius	8 mm
Bending radius	8 mm
Tiefenschärfe	5-50 mm
Depth of focus	5-50 mm
Gewicht	260 g
Weight	260 g
inkl. Dichtigkeitstester	
incl. leak tester	



Art.-Nr.	Blickfeld	
Art.-No.	Field of vision	
130 400 028ST	100°	2,8 mm / 2.8 mm
130 400 034ST	80°	3,4 mm / 3.4 mm
130 414 040ST	80°	Ø 4 mm mit Arbeitskanal, Ø 1,4 mm Ø 4 mm with working channel, Ø 1.4 mm

Unsere Nasopharyngoskope der neuesten Generation sind intuitiv bedienbar und ergonomisch optimiert. Sie wurden für die notwendige Feinfühligkeit im täglichen Routineeinsatz und für eine ermüdungsfreie Handhabung entwickelt.

Hochwertige Bildleiter und ein leistungsfähiges optisches System liefern große und helle Bilder in bester Auflösung - die Voraussetzung für eine sichere Diagnose und Therapie. Dank solider Verarbeitung und konsequenter Verwendung moderner Hochleistungswerkstoffe sind unsere Nasopharyngoskope äußerst robust und langlebig - trotz steigender Belastung durch moderne Aufbereitungsverfahren.

Our newest generation nasopharyngoscopes impresses with intuitive operability and optimal ergonomics, designed for tactile sensation and non-tiring handling as required in daily routine operations.

High-end fibre-optic bundles and a high-capacity system produce large and bright images of the best quality - necessary for safe diagnosis and treatment. Due to the consistent use and reliable processing of high-class materials, our nasopharyngoscopes are robust and durable, in spite of the increasing stress of modern cleaning and sterilizing facilities.

Vorteile unserer Endoskope:

- Funktionelles Design für eine einfache und komfortable Handhabung
- Feinfühlig, aber robuste Steuerung
- Optimale Flexibilität und Torsionssteifigkeit des Einführungschafts
- Leistungsfähiges optisches System: größere, hellere und schärfere Bilder

Geeignete Wiederaufbereitungsverfahren:

- Einlegbar in Reinigungs- und Desinfektionslösung
- NTDF-Sterilisation = Niedertemperatur-Dampf-Formaldehyd-Sterilisation
- Maschinelle Aufbereitung (RDG-E)

Advantages of our endoscopes:

- Functional design for easy and comfortable handling
- Sensitive yet robust control
- Optimal flexibility and torsional rigidity of the insertion channel
- High-performance optical system for larger, brighter and sharper images

Suitable reprocessing procedures:

- Fully immersible in cleaning and disinfectant solutions
- LTSF-sterilization = Low-Temperature Steam and Formaldehyde sterilization
- Machine reprocessing (RDG-E)



02 Nasen-Spekula

Nasal Specula

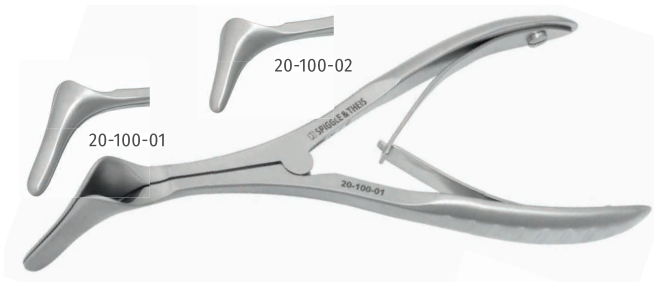

Hartmann Nasenspekulum, zerlegbar Hartmann nasal speculum, dismountable

Art.-Nr. Art.-No.		Größe Size (mm)	Länge Length (cm)
20-100-01	Für Erwachsene for adults	34	13,5
20-100-02	Für Jugendliche for juveniles	27	13,0



Tieck-Halle Nasenspekulum, zerlegbar, 13 cm Tieck-Halle nasal speculum, dismountable, 13 cm

Art.-Nr./No.		Größe / Size (cm)
20-101-00	Für Kinder / for children	2,10
20-101-01	Für Neugeborene / for newborn	1,75



Nasenspekulum, Modell Wien, zerlegbar, 14 cm Nasal speculum type Vienna, dismountable, 14 cm

Art.-Nr./No.		Größe / Size (cm)
20-102-01	Für Kinder / for children	2,60
20-102-02	Für Jugendliche / for juveniles	2,95
20-102-03	Für Erwachsene / for adult	3,30



Hartmann-Halle Nasenspekulum, flaches Blatt, zerlegbar, 15,5 cm Hartmann-Halle nasal speculum, flat blade, dismountable, 15,5 cm

Art.-Nr./No.		Größe / Size (mm)	Größe / Size
20-110-01	Für Kinder for children	2,9	1
20-110-02	Für Jugendliche for juveniles	3,2	2
20-110-03	Für Erwachsene for adult	3,6	3



Hartmann Nasenspekulum, zerlegbar, 15 cm Hartmann nasal speculum, dismountable, 15 cm

Art.-Nr./No.	Größe / Size (cm)	Größe / Size
20-112-01	2,7	1
20-112-02	3,0	2
20-112-03	3,4	3



Beckmann Nasenspekulum, seitlich gebogen, Größe 2,5 cm, 15 cm
Beckmann nasal speculum, curved to side, size 2.5 cm, 15 cm

20-115-00



Killian Septumspekulum, 14 cm

Killian septum speculum, 14 cm

Art.-Nr./No.	Größe / Size (cm)
20-148-40	4,0
20-148-55	5,5
20-148-75	7,5
20-148-90	9,0



Cottle Septumspekulum, Größe 5,2 cm, 13 cm

Cottle septum speculum, size 5.2 cm, 13 cm

20-149-55



Killian-Struycken Septumspekulum, 14 cm

Killian-Struycken septum speculum, 14 cm

Art.-Nr./No.	Größe / Size (cm)
20-150-40	4,5
20-150-55	5,5
20-150-65	6,5
20-150-75	7,5
20-150-90	9,0



02 Nasen-Spekula

Nasal Specula



Herberhold Septumspeculum, extra fein, geriefte Außenfläche, 13 cm
Herberhold septum speculum, extra fine, serrated blades, 13 cm

Art.-Nr./No.	Größe / Size (cm)
20-152-40	3,5
20-152-55	5,0
20-152-75	7,5
20-152-90	9,0
20-147-55*	5,2

*mit Stellschraube/with setting screw



Cottle Septumspeculum mit Stellschraube, 13 cm
Cottle septum speculum with setting screw, 13 cm

Art.-Nr./No.	Größe / Size (cm)
20-151-40	3,5
20-151-55	5,2
20-151-75	7,5
20-151-90	9,0



Cottle Septumspeculum, schwarz, extra dünne Blätter, mit Stellschraube, 13 cm
Cottle septum speculum, black, very thin blades, with setting screw, 13 cm

Art.-Nr./No.	Größe / Size (cm)
20-153-40	3,5
20-153-45	4,5
20-153-55	5,0
20-153-75	7,5



Killian Septumspeculum mit Lichtträger, 14 cm
Killian septum speculum with fibre light carrier, 14 cm

Art.-Nr./No.	Länge / Length (cm)	Größe / Size (cm)
20-155-40	14	4,0
20-155-55	14	5,5
20-155-75	14	7,5
20-155-90	14	9,0
20-155-00	16	Lichtträger allein fibre light carrier



Cottle selbsthaltendes Septumspekulum für flexiblen Spannarm, mit Stellschraube, 14 cm
Cottle self-holding septum speculum for flexible holding arm, with setting screw, 14 cm

Art.-Nr./No.	Größe / Size (cm)
20-156-40	4,0
20-156-55	5,5
20-156-75	7,5
20-156-90	9,0



Selbsthaltendes Spekulum mit Stellschraube, rechts und links gezahnt, 15 cm
Self-holding speculum with setting screw, teeth left and right, 15 cm

30-711-00

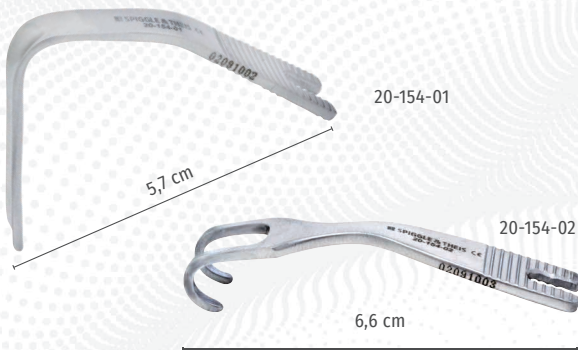

Aufricht Haken für flexiblen Spannarm
Aufricht retractor for flexible holding arm

Art.-Nr./No.	Größe / Size (cm)	Beschreibung / Description
20-154-01	5,7	einfach / simple
20-154-02	6,6	Zwei Zähne / two teeth



Flexibler Spannarm zur Verwendung mit selbsthaltenden NNH-Spekula, mit Verlängerungsstange
Flexible holding arm for use with self retaining nasal specula, including holding rods

30-700-00



Gelenkkloben zur Befestigung am OP-Tisch, passend für 30-700-00 und 40-337-00
Rotation clamp for fixation to operating table, for 30-700-00 and 40-337-00

30-700-01



03 Untersuchungsinstrumente

Examination Instruments

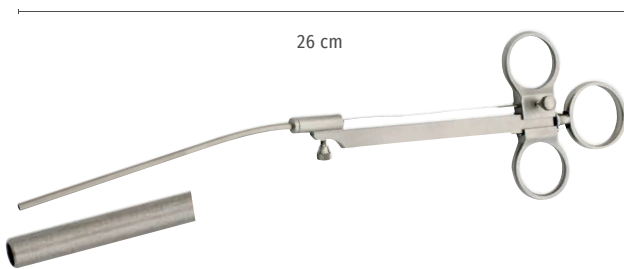

Krause Nasen-Polypen-Schnürer, scharf, 26 cm
Krause nasal polyp snare, sharp, 26 cm

20-190-25

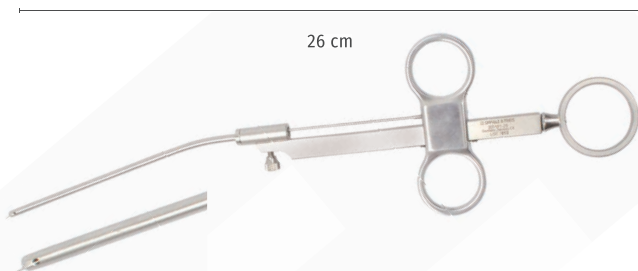

Krause-Voss Nasen-Polypen-Schnürer, stumpf, 26 cm
Krause-Voss nasal polyp snare, blunt, 26 cm

20-191-25

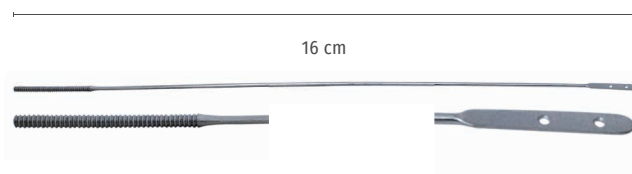

Ziehstange für Nasen-Polypen-Schnürer, 16 cm,
passend für 20-190-25 und 20-191-25

Stylet for nasal polyp snares, 16 cm,
compatible to 20-190-25 and 20-191-25

20-191-00

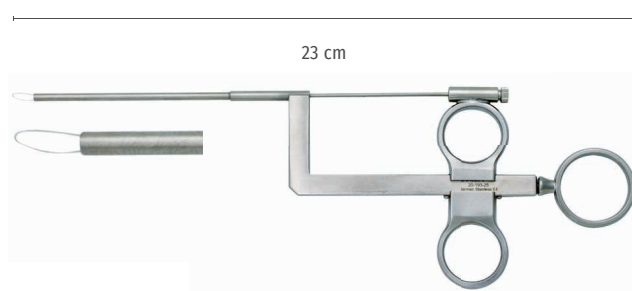

Lange Nasen-Polypen-Schnürer, bajonett, scharf, 23 cm
Lange nasal polyp snare, bayonet, sharp, 23 cm

20-193-25



Nasenpolypenschlingen, 0,35 mm, 10 cm, 100 Stück
Nasal polyp snare wires, 0.35 mm, 10 cm, 100 pieces

20-195-35

03 Untersuchungsinstrumente

Examination Instruments



Hartmann Nasentamponadezange

Hartmann nasal dressing forceps

Art.-Nr./No.	Größe / Size (cm)	Beschreibung / Description
20-200-16	18	fein / delicate
20-200-20	20	



Westmacott Nasentamponadezange, schmal, 20 cm

Westmacott nasal sponge holding forceps, slender, 20 cm

20-207-20

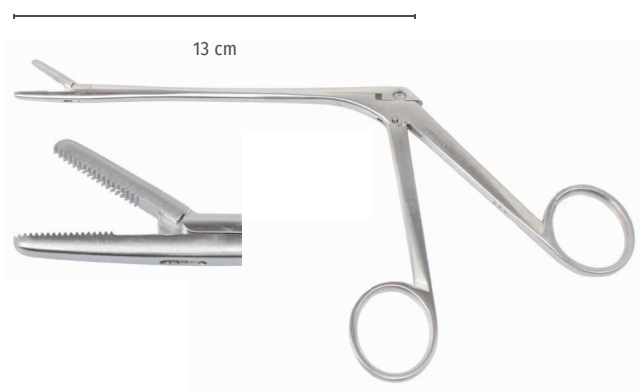

Noyes Nasentamponadezange, fein gerieft, 13 cm

Noyes nasal sponge holding forceps, fine, 13 cm

20-208-20



03 Untersuchungsinstrumente

Examination Instruments



Kabierske Pulverbläser, komplett mit drei Kanülen für Ohr, Nase, Rachen, Hals; mit Glas und Ventilball

Kabierske powder blower, complete with three cannulae for ear, nose, pharynx, larynx; with bottle and rubber ball

10-155-00



Kabierske Ersatzglas, 30 ccm

Kabierske spare bottle, 30 ccm

10-155-01



Kabierske Ventilball

Kabierske rubber ball

10-155-02



Kabierske Kanüle, gerade

Kabierske cannula, straight

Art.-Nr./No.	Länge / Length (cm)
10-155-08	8
10-155-11	11



Kabierske Kanüle, gebogen, 13,5 cm

Kabierske cannula, curved, 13.5 cm

10-155-13



Abbildung ähnlich / similar to illustration

Glatzel Nasenspiegel, hochglänzend, 20 x 13 cm

Glatzel nasal mirror, high gloss, 20 x 13 cm

20-198-00

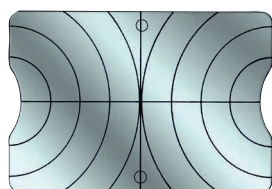

Saugrohr mit abgeflachtem Ende, Ø 5 mm, 15,5 cm

Suction tube with flattened end, Ø 5 mm, 15.5 cm

20-199-05

03 Untersuchungsinstrumente

Examination Instruments

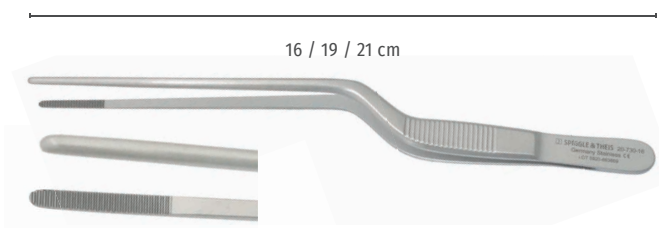

Jansen Nasenpinzette, bajonett, anatomisch

Jansen nasal forceps, bayonet, anatomical

Art.-Nr./No.	Länge / Length (cm)
20-730-16	16
20-730-19	19
20-730-21	21

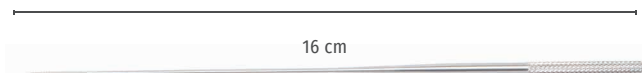

Watteträger, Ø 1,2 mm, 16 cm, 5 Stück

Cotton carrier, Ø 1.2 mm, 16 cm, 5 pieces

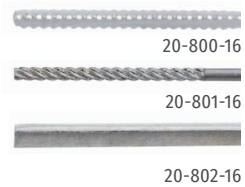

Art.-Nr./No.	Beschreibung / Description
20-800-16	dreikant, gerieft / triangle, serrated
20-801-16	rund, gerieft / round, serrated
20-802-16	dreikant, glatt / triangular, smooth



Saugrohr, kniegebogen, zylindrisch

Suction tube, angled, cylindrical

Art.-Nr./No.	AD / OD (mm)	Länge / Length (cm)
10-300-10	1,0	9
10-300-15	1,5	9
10-300-20	2,0	9
10-300-25	2,5	11
10-300-30	3,0	11
10-300-35	3,5	11
10-300-40	4,0	11
10-300-50	5,0	11

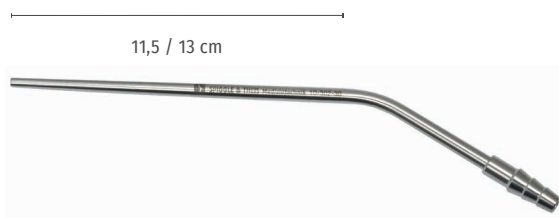

Saugrohr, kniegebogen, konisch

Suction tube, angled, conical

Art.-Nr./No.	AD / OD (mm)	Länge / Length (cm)
10-302-30	3,0	11,5
10-302-35	3,5	11,5
10-302-45	4,5	13,0



Saugrohr, gerade, biegsam, konisch, 3,0 mm, 19,5 cm

Suction tube, straight, bendable, conical, 3.0 mm, 19.5 cm

10-303-18



03 Untersuchungsinstrumente

Examination Instruments

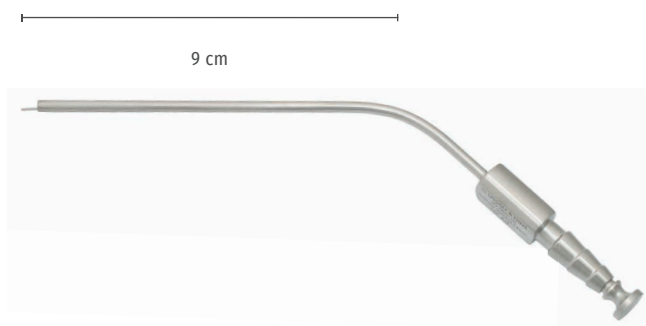

Frazier Saugrohr, mit Griffplatte und Unterbrecher, 9 cm
Frazier suction tube, with suction control, 9 cm

Art.-Nr. Art.-No.	AD / OD Ch / Fr	AD / OD mm
30-080-05	5	1,7
30-080-06	6	2,0
30-080-07	7	2,3
30-080-08	8	2,7
30-080-09	9	3,0
30-080-10	10	3,3
30-080-12	12	4,0
30-080-15	15	5,0

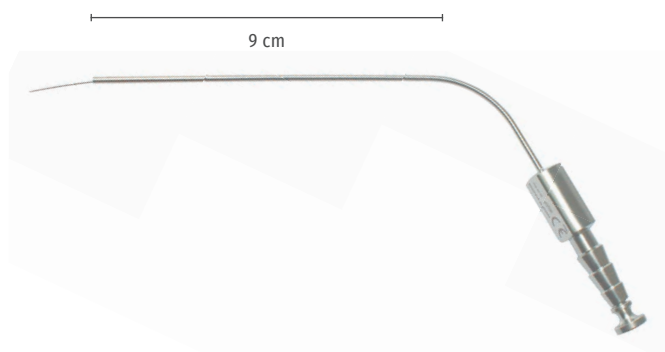

Ferguson Saugrohr mit Griffplatte und Unterbrecher, 9 cm
Ferguson suction tube with suction control, 9 cm

Art.-Nr. Art.-No.	AD / OD Ch / Fr	AD / OD mm
30-081-06	6	2,0
30-081-08	8	2,7

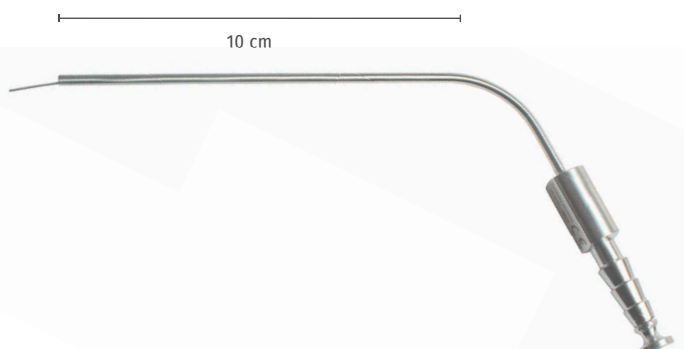

Ferguson Saugrohr mit Griffplatte und Unterbrecher, 10 cm
Ferguson suction tube with suction control, 10 cm

Art.-Nr. Art.-No.	AD / OD Ch / Fr	AD / OD mm
30-081-09	9	3,0
30-081-10	10	3,3
30-081-12	12	4,0
30-081-15	15	5,0



**Frazier Saugrohr, konisch,
mit tränenförmiger Saugsteuerung, 8 cm**
**Frazier suction tube, conical,
with tearform suction control, 8 cm**

Art.-Nr. Art.-No.	AD / OD Ch / Fr	AD / OD mm
30-105-06	6	2,3
30-105-08	8	2,8
30-105-10	10	3,3

04 Septum Instrumente Blakesley Komfort Serie Nasenzange

Septum Instruments Blakesley Comfort Series nasal forceps



Blakesley Nasenzange, komfort, durchschneidend, Druckknopf vergoldet
Blakesley nasal forceps, comfort, throughcutting, golden button

Art.-Nr. Art.-No.	Länge Length (cm)	Größe Size (mm)	Winkel Angle
20-915-00	12	3,0	gerade / straight
20-915-01	12	3,5	gerade / straight
20-915-02	12	4,0	gerade / straight
20-915-03	12	5,0	gerade / straight
20-915-04	12	6,0	gerade / straight
20-915-10	15	3,0	gerade / straight
20-915-12	15	4,0	gerade / straight
20-925-00	12	3,0	45° aufgebogen / 45° curved upwards
20-925-01	12	3,5	45° aufgebogen / 45° curved upwards
20-925-02	12	4,0	45° aufgebogen / 45° curved upwards
20-925-03	12	5,0	45° aufgebogen / 45° curved upwards
20-925-04	12	6,0	45° aufgebogen / 45° curved upwards
20-935-01	12	3,5	90° aufgebogen / 90° curved upwards
20-935-02	12	4,0	90° aufgebogen / 90° curved upwards
30-943-01	12	1,9 x 5,0	gerade / straight
30-943-02	12	2,5 x 6,0	gerade / straight
30-943-03	12	3,0 x 7,0	gerade / straight
30-943-04	12	3,8 x 10	gerade / straight
30-943-11	12	1,9 x 5,0	45° aufgebogen / 45° curved upwards
30-943-12	12	2,5 x 6,0	45° aufgebogen / 45° curved upwards
30-943-13	12	3,0 x 7,0	45° aufgebogen / 45° curved upwards

Vorteile

- Schnelle und einfache Öffnung des Schiebeschafts
- Validierte Reinigung
- Sichere Lagerung in der Abwurfsiebschale
- Höhere Standzeit

Advantages

- Quick and easy opening of the sliding shaft
- Guaranteed cleaning
- Safe and comfortable storage
- Made to last



04 Septum Instrumente, Blakesley Nasenzange, Premium Modell

Septum Instruments Blakesley premium model nasal forceps



gerade / straight

Art.-Nr./No.	Größe Size (mm)		Länge Length (cm)
20-215-00	3,0		11,5
20-215-01	3,5		11,5
20-215-02	4,0		11,5
20-215-03	5,0		11,5
20-215-04	6,0		11,5
20-215-10	3,0		15,0
20-215-12	4,0		15,0
20-215-14	6,0		15,0



45° aufgebogen, 11,5 cm / curved upwards 45°, 11.5 cm

Art.-Nr./No.	Größe / Size (mm)	
20-225-00	3,0	
20-225-01	3,5	
20-225-02	4,0	
20-225-03	5,0	
20-225-04	6,0	

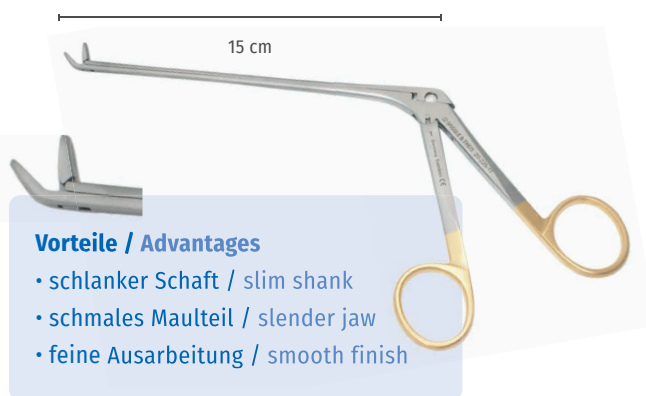

45° aufgebogen, 15 cm / curved upwards 45°, 15 cm

Art.-Nr./No.	Größe / Size (mm)	
20-225-11	3,5	
20-225-12	4,0	
20-225-14	6,0	



90° aufgebogen, 11,5 cm / curved upwards 90°, 11.5 cm

Art.-Nr./No.	Größe / Size (mm)	
20-235-01	3,5	
20-235-02	4,0	
20-235-03	5,0	

04 Nasenzangen / Nasenscheren

Nasal Forceps / Nasal Scissors

Black Line
Ultimate Edition

Blakesley Nasenzange Black Line, DLC-Beschichtung Blakesley nasal forceps Black Line, DLC coating



Art.-Nr. Art.-No.	Länge Length (cm)	Größe Size (mm)	Winkel Angle
20-215-00B	12,0	3,0	gerade / straight
20-215-01B	12,0	3,5	gerade / straight
20-215-02B	12,0	4,0	gerade / straight
20-215-03B	12,0	5,0	gerade / straight
20-215-04B	12,0	6,0	gerade / straight
20-225-00B	12,0	3,0	45° aufgebogen curved upwards
20-225-01B	12,0	3,5	45° aufgebogen curved upwards
20-225-02B	12,0	4,0	45° aufgebogen curved upwards
20-225-03B	12,0	5,0	45° aufgebogen curved upwards
20-225-11B	15,0	3,5	45° aufgebogen curved upwards
20-225-12B	15,0	4,0	45° aufgebogen curved upwards
20-225-14B	15,0	6,0	45° aufgebogen curved upwards
20-235-01B	12,0	3,5	90° aufgebogen curved upwards
20-235-02B	12,0	4,0	90° aufgebogen curved upwards
20-235-03B	12,0	5,0	90° aufgebogen curved upwards



Strümpel-Voss Nasenzange, 45°, 11,5 cm Strümpel-Voss nasal forceps, 45°, 11,5 cm

20-238-00



Takahashi Nasenzange / Takahashi nasal forceps

Art.-Nr. Art.-No.	Länge Length (cm)	Größe Size (mm)	Winkel Angle
20-245-01	11,5	2,5	gerade / straight
20-245-02	11,5	2,5	30° aufgebogen curved upwards
20-245-11	15,0	2,5	gerade / straight
20-245-12	15,0	2,5	30° aufgebogen curved upwards
20-246-01	11,5	4,0	gerade / straight
20-246-02	11,5	4,0	30° aufgebogen curved upwards



04 Nasenzangen / Nasenscheren

Nasal Forceps / Nasal Scissors

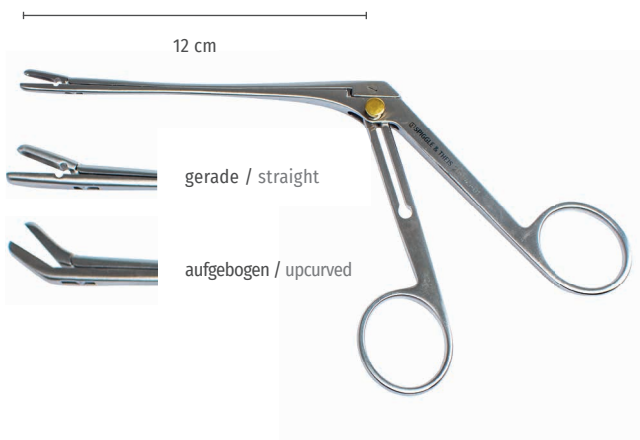

Takahashi Nasenzange, komfort, Druckknopf vergoldet, 12 cm
Takahashi nasal forceps, comfort, golden button, 12 cm

Art.-Nr./No.	Größe / Size (mm)	Winkel / Angle
20-945-01	2,5	gerade / straight
20-945-02	2,5	45° aufgebogen 45° curved upwards
20-946-01	4,0	gerade / straight
20-946-02	4,0	45° aufgebogen 45° curved upwards

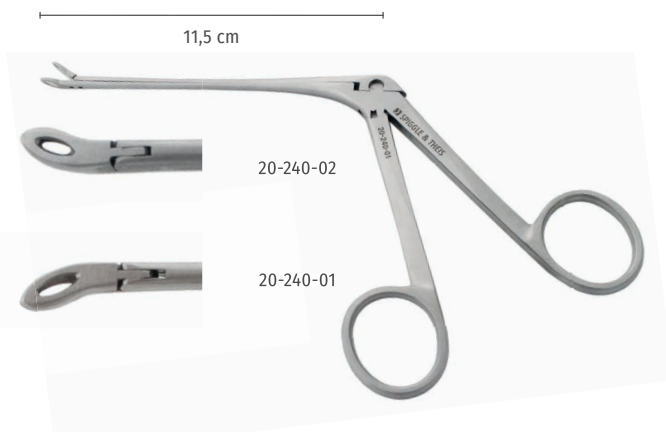

Blakesley Nasenzange / Blakesley nasal forceps

Art.-Nr./No.	Größe / Size (cm)	Beschreibung / Description
20-240-01	11,5	links gebogen / curved left
20-240-02	11,5	rechts gebogen / curved right



Watson-Williams Nasenzange, gerade, gezahnt, 11,5 cm
Watson-Williams nasal forceps, straight, serrated, 11.5 cm

20-248-00



Ferris-Smith Nasenzange, quengerieft, mit Loch, 11,5 cm
Ferris-Smith nasal forceps, serrated, with hole, 11.5 cm

20-249-00

04 Nasenzangen / Nasenscheren

Nasal Forceps / Nasal Scissors



Craig Septum-Zange, scharfe Löffel, gerade, 9,5 cm
Craig septum forceps, sharp cups, straight, 9.5 cm

20-258-00



Craig-Domnick Septum-Zange, scharfe Löffel, links gebogen, 10 cm
Craig-Domnick septum forceps, sharp cups, left curved, 10 cm

20-259-00



Kazanjian Knochenzange, gerade, 19 cm
Kazanjian rongeur, straight, 19 cm

20-270-19



Rowland Nasenzange, Doppelgelenk, gerade, 14,5 cm
Rowland rongeur, double joint, straight, 14.5 cm

20-274-18



04 Nasenzangen / Nasenscheren

Nasal Forceps / Nasal Scissors



Caplan Nasenschere, Doppelgelenk, gebogen, 20,5 cm
Caplan nasal scissors, double joint, angled, 20.5 cm

20-272-21



Struycken Nasenzange, durchschneidend, gerade, 1,0 mm, 11,5 cm Arbeitslänge

Struycken nasal forceps, throughcutting, straight, 1.0 mm, 11.5 cm working length

20-250-00



Hartmann Conchotom, rund, 12 cm

Hartmann cutting forceps, round, 12 cm

Art.-Nr./No. Größe / Size Größe / Size (mm)

20-252-01 1 7



20-252-02 2 8



20-252-03 3 9



20-252-04 4 10



2259

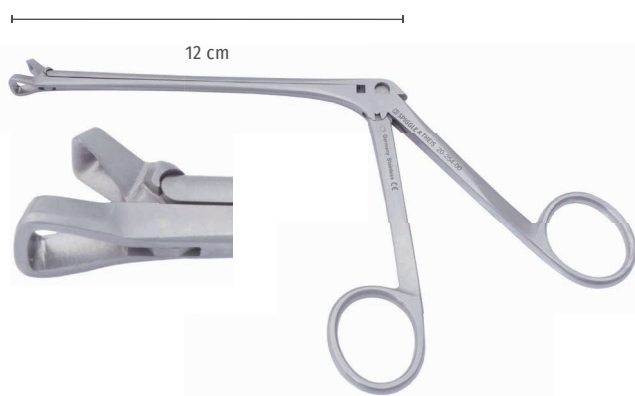

Schmeden Conchotom, dreieckig, 12 cm

Schmeden cutting forceps, triangular, 12 cm

Art.-Nr./No. Größe / Size Größe / Size (mm)

20-254-00 0 6



20-254-01 1 7



20-254-02 2 8



20-254-03 3 12



04 Nasenzangen / Nasenscheren

Nasal Forceps / Nasal Scissors

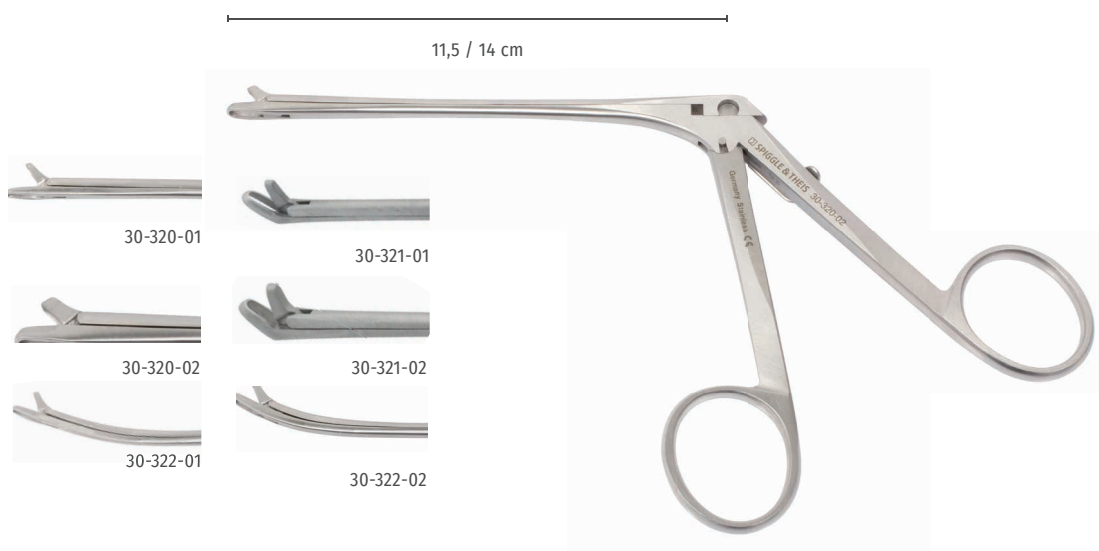

Durchschneidende Nasenzange / Throughcutting nasal forceps

Art.-Nr. Art.-No.	Größe Size (mm)	Länge Length (cm)	Winkel Angle
30-320-01	5,0 x 1,5	14,0	gerade / straight
30-320-02	6,5 x 2,5	11,5	gerade / straight
30-321-01	5,0 x 1,5	14,0	45° gewinkelt / 45° angled
30-321-02	6,5 x 2,5	11,5	45° gewinkelt / 45° angled
30-322-01	5,0 x 1,5	14,0	aufgebogen / curved upwards
30-322-02	8,0 x 3,0	14,0	aufgebogen / curved upwards

Vorteile / Advantages

- Stumpfes Ende = Dura-Schutz
Blunt end = dura protection



Wigand Polypen-Fasszange, aufgebogen 60°, 11,5 cm

Wigand polyp-grasping forceps, 60° angled, 11.5 cm

20-236-00



04 Nasenzangen / Nasenscheren

Nasal Forceps / Nasal Scissors



Diese Scheren eignen sich hervorragend zur Eröffnung von Siebbeinzellen, unter weitgehender Erhaltung der Schleimhaut.

Ein „Anstechen“ und nicht „Vorschieben“ der Siebbeinschleimhaut ist mit der extra feinen und verlängerten, unteren Schneide gewährleistet.

Dr. med. Hohenhorst,
Chefarzt der HNO Abteilung des
Alfried Krupp Krankenhauses in Essen

These scissors are ideally suited for opening ethmoidal cells while keeping the mucous membrane largely intact.

The super-fine and elongated lower blade ensures that the mucous membrane of the ethmoid bone is “punctured” and not “pushed forward.”

Dr. med. Hohenhorst,
Chief physician of the ENT department
of the Alfred Krupp Clinic, Essen, Germany

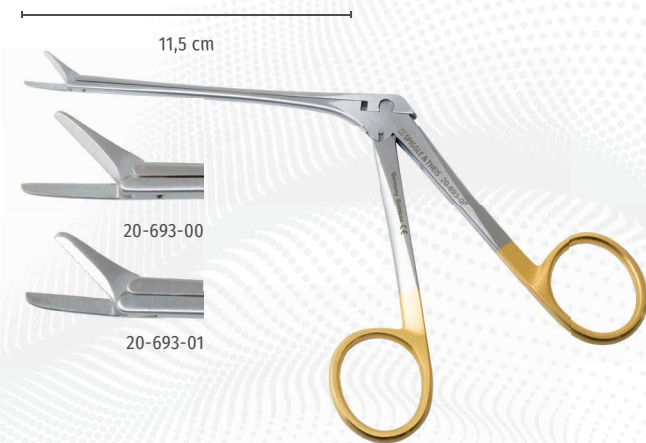

Conchotomie Schere, gerade, 11,5 cm

Conchotomy scissors, straight, 11.5 cm

Art.-Nr./No.	Beschreibung / Description
20-693-00	standard / standard
20-693-01	extra fein / extra delicate
20-693-02	extra fein, spitz, untere Schneide verlängert extra delicate, pointed, lower blade longer

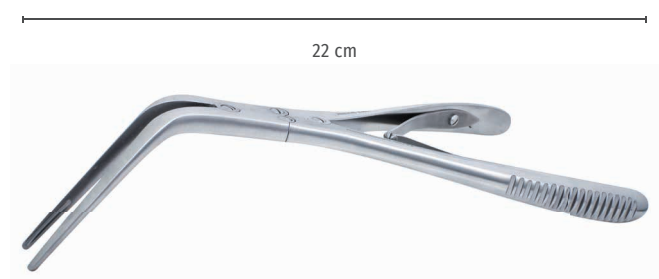

Kressner Muschelquetschzange, gebogen, 3 mm, 22 cm

Kressner turbinate crushing forceps, curved, 3 mm, 22 cm

20-280-21

04 Nasenzangen / Nasenscheren

Nasal Forceps / Nasal Scissors

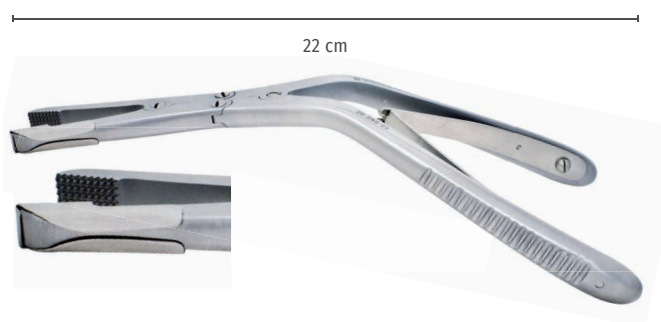

Rubin Knorpelquetschzange, Doppelgelenk, gebogen, 22 cm
Rubin morcelizer forceps, double joint, curved, 22 cm

20-282-22



Schutzhülse für Rubin Knorpelquetschzange 20-282-22
Sleeve for Rubin morcelizer forceps 20-282-22

20-282-99

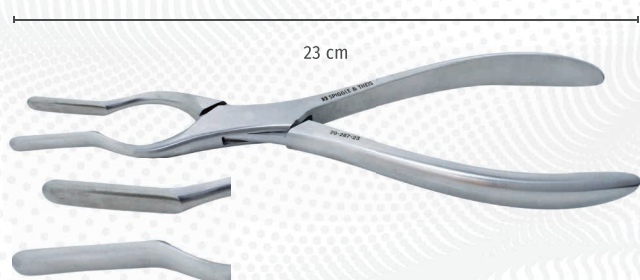

Cottle-Walsham Septumrichtzange, gerade, 23 cm

Cottle-Walsham septum straightening forceps, straight, 23 cm

20-287-23



Cottle-Walsham Septumrichtzange, zerlegbar, 22 cm

Cottle-Walsham septum straightening forceps,
dismountable, 22 cm

20-288-23

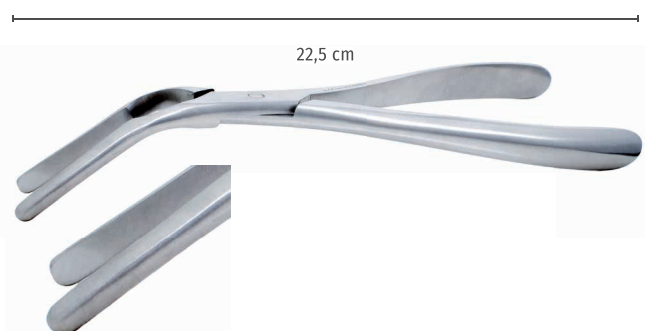

Ash Septumrichtzange, gebogen, 22,5 cm

Ash septum straightening forceps, curved, 22.5 cm

20-290-22



04 Nasenzangen / Nasenscheren

Nasal Forceps / Nasal Scissors



Jansen-Middleton Septumzange, Doppelgelenk, gewinkelt
Jansen-Middleton septum forceps, double action, angled

Art.-Nr. Art.-No.	Breite Width (mm)	Beschreibung Description
25-100-05	5,0	mit Löffel / cupped jaws
25-100-46	4,6	durchschneidend throughcutting



Becker Nasenschere, Doppelgelenk, abgewinkelt
Becker nasal scissors, double action, angled

25-100-21

05 Elevatoren / Raspatorien

Elevators / Raspatories

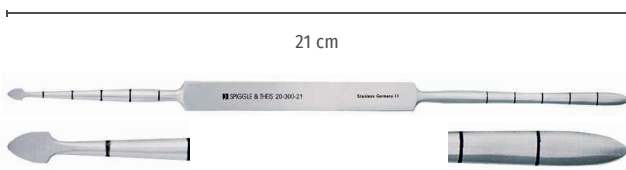

Masing Elevatorium/Raspatorium, 21 cm

Masing elevator/raspatory, 21 cm

20-300-21



Cottle Elevatorium/Raspatorium, 23 cm

Cottle elevator/raspatory, 23 cm

20-301-23

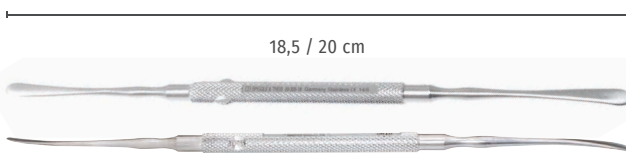

Freer Doppelevatorium, scharf-stumpf

Freer elevator, double ended, sharp-blunt

Art.-Nr./No.	Länge / length (cm)
20-305-18	18,5
20-306-20	20,0



Weber Doppelevatorium, scharf/stumpf, 18,5 cm

Weber elevator, double ended, sharp/blunt, 18.5 cm

20-307-18



McKenty Doppelraspatorium, leicht/stark gebogen, 22 cm

McKenty raspatory, double ended, slightly/strongly curved, 22 cm

20-308-22

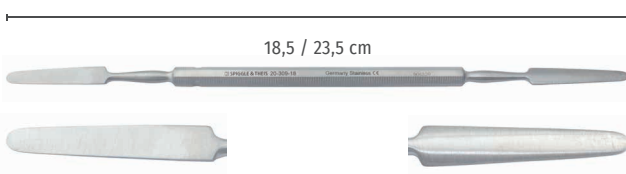

Killian Raspatorium, doppelseitig, scharf/stumpf

Killian raspatory, double ended, sharp/blunt

Art.-Nr./No.	Länge / length (cm)
20-309-18	18,5
20-309-20	23,5



Freer Golfstock-Raspatorium, 19 cm

Freer golf club raspatory, 19 cm

20-310-19



05 Elevatoren / Raspatorien

Elevators / Raspatories

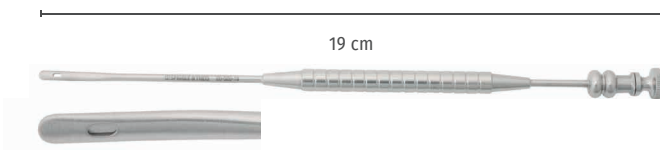

Gourney Saugelevatorium, 3 mm, 19 cm
Gourney suction elevator, 3 mm, 19 cm

20-320-19

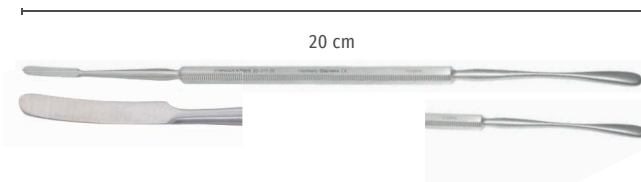

Freer-Joseph Doppel-Raspatorium, 20 cm
Freer-Joseph raspatory, double-ended, 20 cm

20-311-20

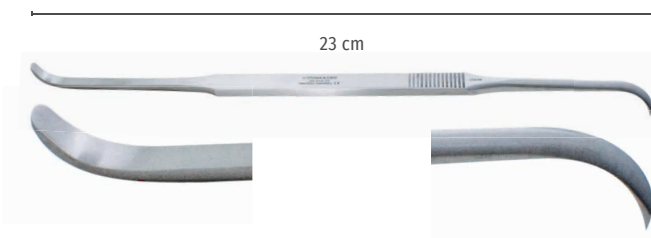

Cottle Tunnel-Raspatorium, doppelseitig, leicht/stark gebogen, 23 cm
Cottle tunneling raspatory, double ended, slightly/strongly curved, 23 cm

20-312-23

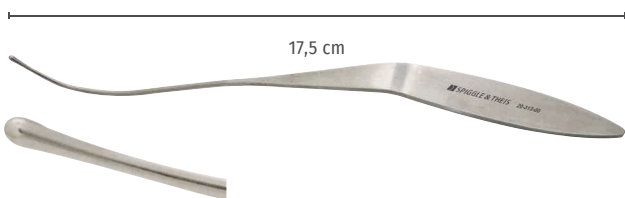

Nasensonde, s-förmig gebogen, biegsam, 17,5 cm
Nasal probe, s-shaped, bendable, 17.5 cm

20-313-00

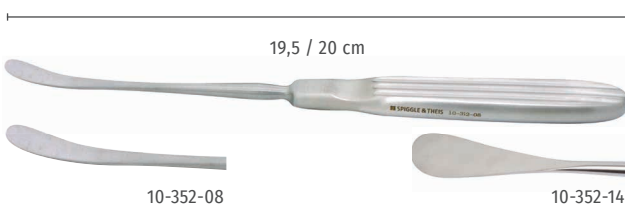

Cottle Raspatorium, gebogen
Cottle raspatory, curved

Art.-Nr./No.	Länge / length (cm)	Größe / Size (mm)
10-352-08	20,0	8
10-352-14	19,5	14

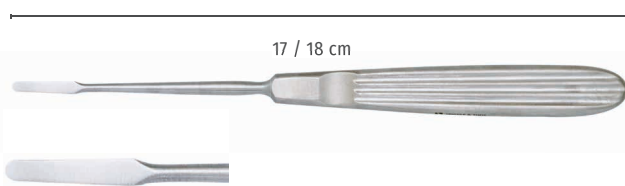

Lempert Raspatorium, gerade / Lempert raspatory, straight

Art.-Nr./No.	Länge / length (cm)	Größe / Size (mm)
10-353-02	17	2
10-353-03	17	3
10-353-04	17	4
10-353-05	17	5
10-353-07	18	7

05 Elevatoren / Raspatorien

Elevators / Raspatories

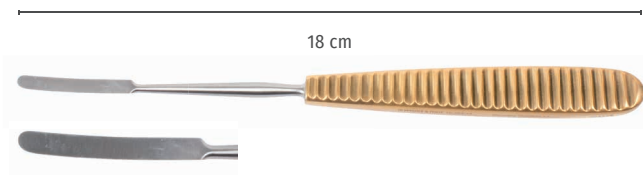

Raspatorium, gerade, vergoldeter Griff, 18 cm
Raspatory, straight, golden handle, 18 cm

10-353-13

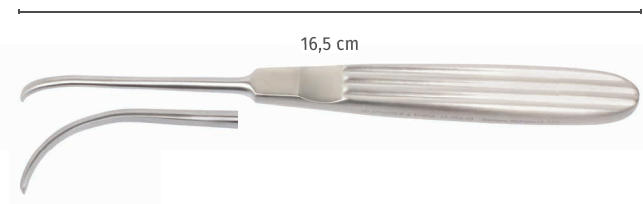

Lempert Raspatorium, stark gebogen, 3 mm, 16,5 cm
Lempert raspatory, strongly curved, 3 mm, 16,5 cm

10-354-03

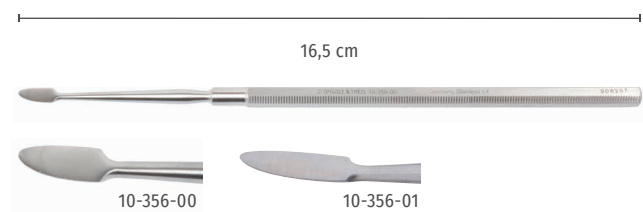

Wullstein Raspatorium, 16,5 cm
Wullstein raspatory, 16.5 cm

Art.-Nr./No.	Größe / Size (mm)
10-356-00	4,0
10-356-01	2,5



Wullstein Raspatorium, abgerundete Ecken, 4 mm, 16,5 cm
Wullstein raspatory, with rounded edges, 4 mm, 16.5 cm

10-357-18

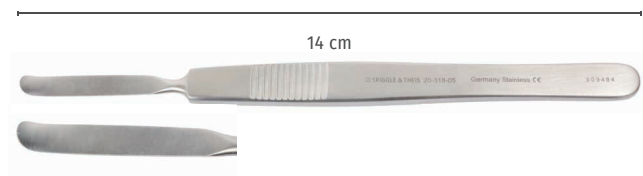

McKenty Raspatorium, stark gebogen, 14 cm
McKenty raspatory, strongly curved, 14 cm

Art.-Nr./No.	Größe / Size (mm)
20-318-04	4,0
20-318-05	5,0



Ulmer Raspatorium, stark gebogen, 4 mm, 16,5 cm
Ulmer raspatory, strongly curved, 4 mm, 16,5 cm

20-319-04



05 Elevatoren / Raspatorien

Elevators / Raspatories



Guillen Saugraspatorium Guillen suction raspatory

Art.-Nr. Art.-No.	Größe Size (mm)	Länge Length (cm)	Beschreibung Description
20-322-01	4,0	20,0	gerade / straight
20-322-02	4,0	20,0	links gebogen curved left
20-322-03	4,0	21,5	rechts gebogen curved right
20-323-01	4,0	15,0	gerade / straight
20-323-02	4,5	15,0	links gebogen curved left
20-323-03	4,5	15,0	rechts gebogen curved right

06 Meißel / Osteotome / Hämmer
Chisels / Osteotomes / Mallets



Cottle Hammer, 18 cm
Cottle mallet, 18 cm

20-400-18



Hajek Metallhammer, 200 g, 20 cm
Hajek metal mallet, 200 g, 20 cm

20-402-21

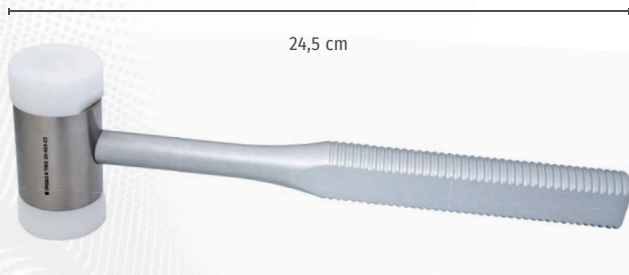

Hammer mit Alugriff und Metallkopf, auswechselbare Nylon-Backen, 24,5 cm
Mallet with aluminum handle, metal head, replaceable nylon facings, 24.5 cm

20-403-23



Hammer mit Silikongriff, 20 cm
Mallet with silicone handle, 20 cm

20-404-20



06 Meißel / Osteotome / Hämmer

Chisels / Osteotomes / Mallets

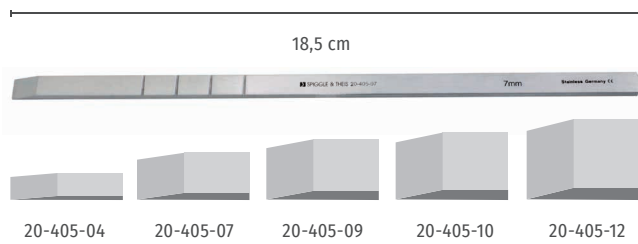

Cottle Meißel, flach, 18,5 cm

Cottle chisel, flat, 18.5 cm

Art.-Nr./No.	Größe / Size (mm)
20-405-04	4,0
20-405-06	6,0
20-405-07	7,0
20-405-09	9,0
20-405-10	10,0
20-405-12	12,0

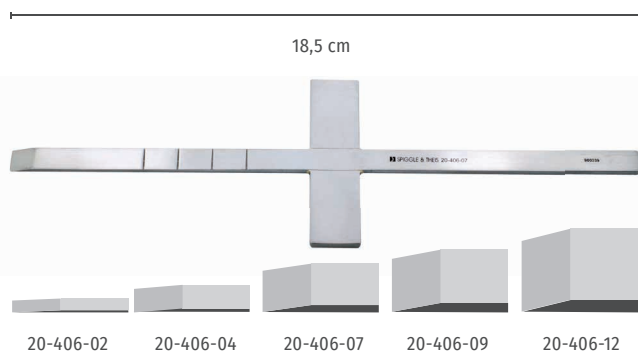

Cottle Meißel, flach, mit Querbalken, 18,5 cm

Cottle chisel, flat, with crossbar, 18.5 cm

Art.-Nr./No.	Größe / Size (mm)
20-406-02	2,0
20-406-04	4,0
20-406-07	7,0
20-406-09	9,0
20-406-12	12,0

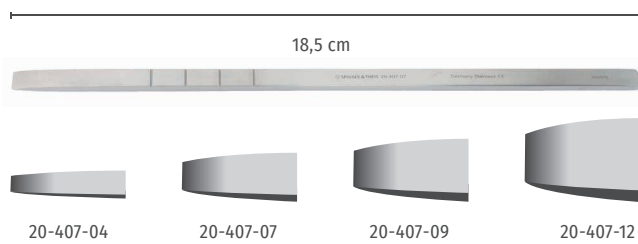

Cottle Osteotom, flach, 18,5 cm

Cottle osteotome, flat, 18.5 cm

Art.-Nr./No.	Größe / Size (mm)
20-407-04	4,0
20-407-07	7,0
20-407-09	9,0
20-407-12	12,0

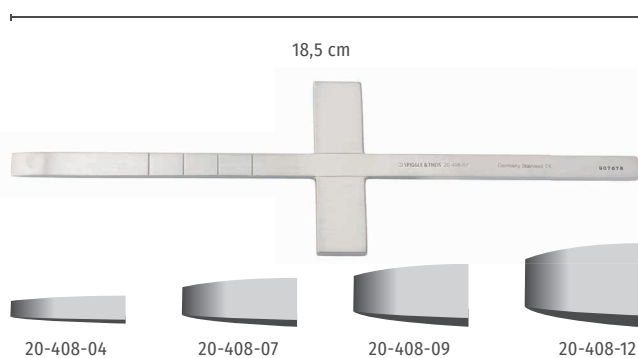

Cottle Osteotom, flach, mit Querbalken, 18,5 cm

Cottle osteotome, flat, with crossbar, 18.5 cm

Art.-Nr./No.	Größe / Size (mm)
20-408-04	4,0
20-408-07	7,0
20-408-09	9,0
20-408-12	12,0

06 Meißel / Osteotome / Hämmer

Chisels / Osteotomes / Mallets

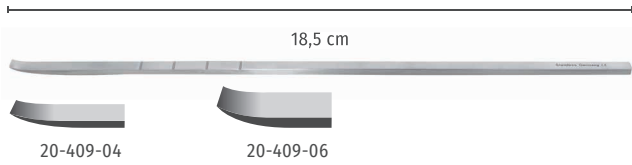

Cottle Meißel, flach, gebogen, 18,5 cm

Cottle chisel, flat, curved, 18.5 cm

Art.-Nr./No.	Größe / Size (mm)
20-409-04	4,0
20-409-06	6,0

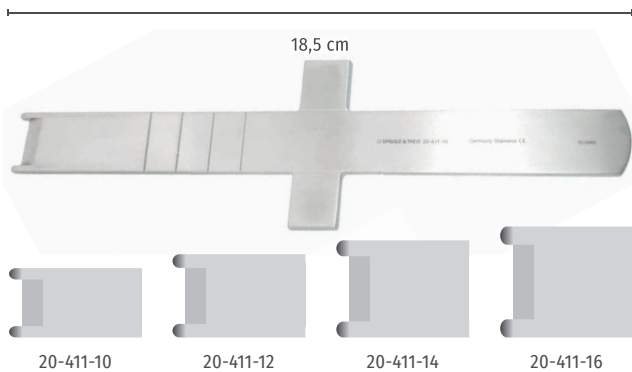

Cottle Osteotom, 2 Führungsdorne, mit Querbalken, 18,5 cm

Cottle osteotome, 2 guards, with crossbar, 18.5 cm

Art.-Nr./No.	Größe / Size (mm)
20-411-10	10,0
20-411-12	12,0
20-411-14	14,0
20-411-16	16,0

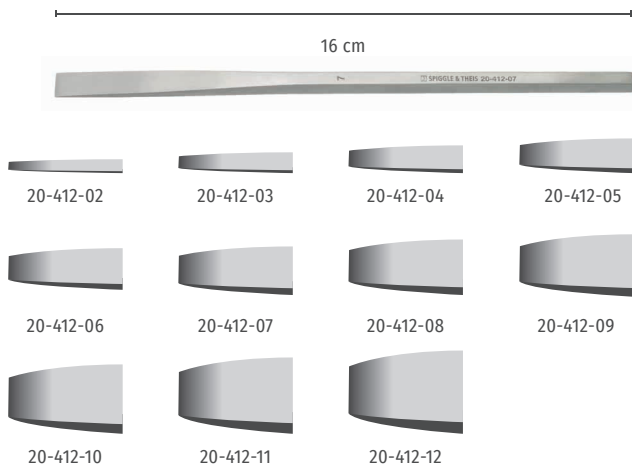

Rubin Osteotom, Sechskant-Griff, gerade, 16 cm

Rubin osteotome, hexagon handle, straight, 16 cm

Art.-Nr./No.	Größe / Size (mm)
20-412-02	2,0
20-412-03	3,0
20-412-04	4,0
20-412-05	5,0
20-412-06	6,0
20-412-07	7,0
20-412-08	8,0
20-412-09	9,0
20-412-10	10,0
20-412-11	11,0
20-412-12	12,0



06 Meißel / Osteotome / Hämmer

Chisels / Osteotomes / Mallets

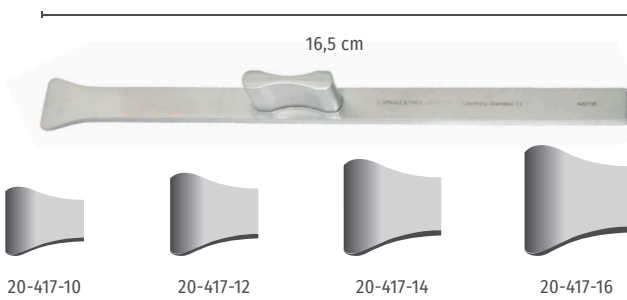

Rubin Osteotom mit Halteknopf, 16,5 cm
Rubin osteotome with stabilizer, 16.5 cm

Art.-Nr./No.	Größe / Size (mm)
20-417-10	10,0
20-417-12	12,0
20-417-14	14,0
20-417-16	16,0

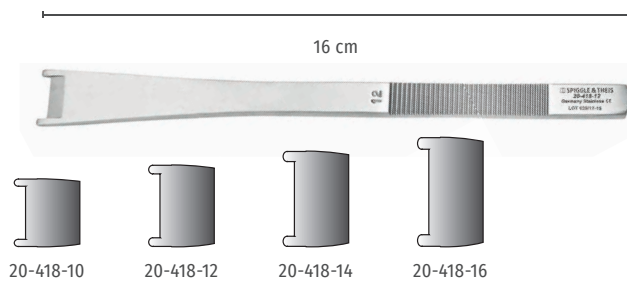

Cinelli Osteotom, 2 Führungsdorne, 16 cm
Cinelli osteotome, double guard, 16 cm

Art.-Nr./No.	Größe / Size (mm)
20-418-10	10,0
20-418-12	12,0
20-418-14	14,0
20-418-16	16,0

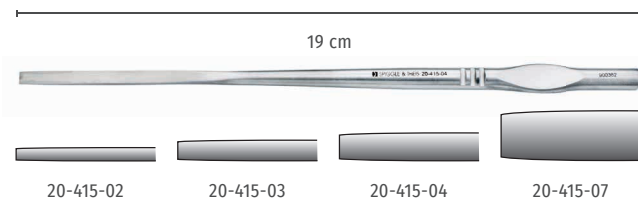

Walter Osteotom, 19 cm
Walter osteotome, 19 cm

Art.-Nr./No.	Größe / Size (mm)
20-415-02	2,0
20-415-03	3,0
20-415-04	4,0
20-415-07	7,0

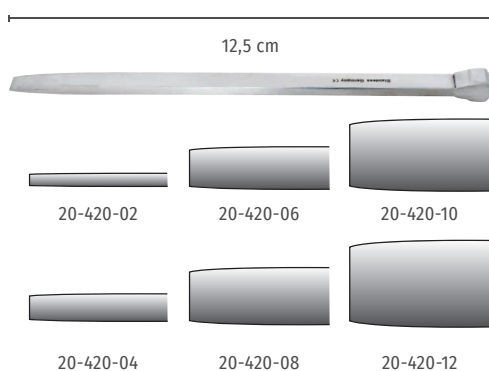

Mini Osteotom, gerade, 12,5 cm
Mini osteotome, straight, 12.5 cm

Art.-Nr./No.	Größe / Size (mm)
20-420-02	2,0
20-420-04	4,0
20-420-06	6,0
20-420-08	8,0
20-420-10	10,0
20-420-12	12,0

06 Meißel / Osteotome / Hämmer

Chisels / Osteotomes / Mallets

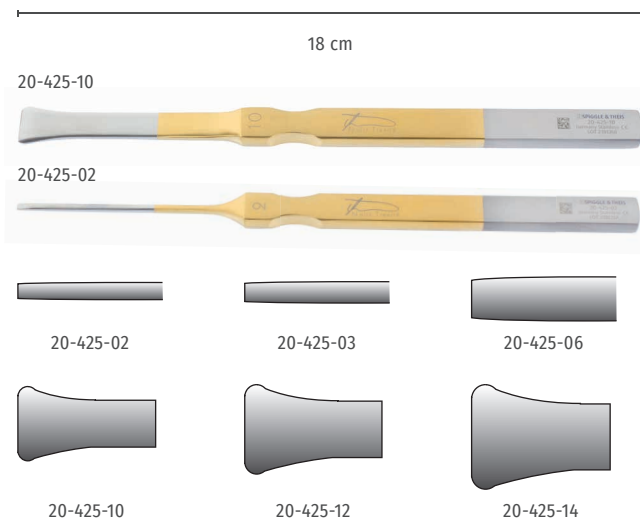

Osteotom Premium Line, goldener Griff

Osteotome Premium Line, golden handle

Art.-Nr./No.	Größe / Size (mm)	Länge / Length (cm)
20-425-02	2,0	18,0
20-425-25	2,5	18,0
20-425-03	3,0	18,0
20-425-04	4,0	18,0
20-425-06	6,0	18,0
20-425-10	10,0	18,0
20-425-12	12,0	18,0
20-425-14	14,0	18,0
20-425-16	16,0	18,0
20-425-18	18,0	18,0

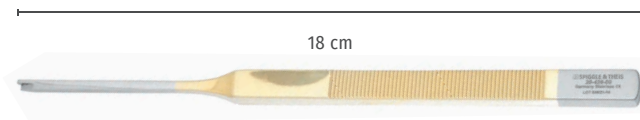

Osteotom Premium Line, goldener Griff, mit Schutzsonde

Osteotome Premium Line, golden handle, guarded

Art.-Nr./No.	Größe / Size (mm)	Länge / Length (cm)
20-426-00	2,2	18,0
20-426-01	3,0	18,0
20-426-02	4,0	18,0



Nasenraspel, doppelseitig, HM, 21 cm

Nasal rasp, double ended, TC, 21 cm

Art.-Nr. Art.-No.	Beschreibung Description (mm)	Länge (cm) Length (cm)
20-427-19	fein / mittel fine / medium	21,0
20-427-20	mittel / grob medium / coarse	21,0



Cottle Knochen- und Knorpelquetscher, mit Entnahmefeder, Griffmulden, vergoldet, Fläche 5x1,5 cm

Cottle bone and cartilage crusher, with clamp, recessed grip, golden, crusher size 5x1.5 cm

20-427-50



06 Meißel / Osteotome / Hämmer
Chisels / Osteotomes / Mallets

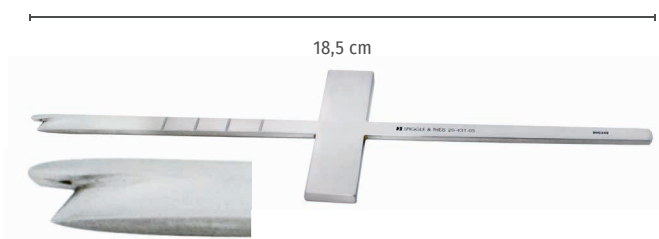

Cottle Osteotom mit Führungsdorn, gerade, 5 mm, 18,5 cm
Cottle osteotome with single guard, straight, 5 mm, 18.5 cm

Art.-Nr./No.	Beschreibung / Description
20-430-05	ohne Querplatte / without crossbar
20-431-05	mit Querplatte / with crossbar

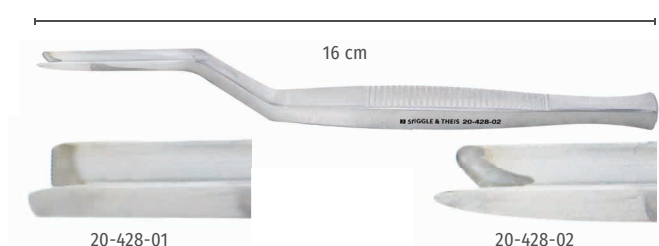

Killian-Claus Hohlmeißel, bajonett, 5,5 mm, 16 cm
Killian-Claus gouge, bayonet, 5.5 mm, 16 cm

Art.-Nr./No.	Beschreibung / Description
20-428-01	gerade / straight
20-428-02	V-Form / V-shaped



Walter Hohlmeißel, 19 cm / Walter gouge, 19 cm

Art.-Nr./No.	Größe / Size (mm)
20-432-03	3,0
20-432-45	4,5

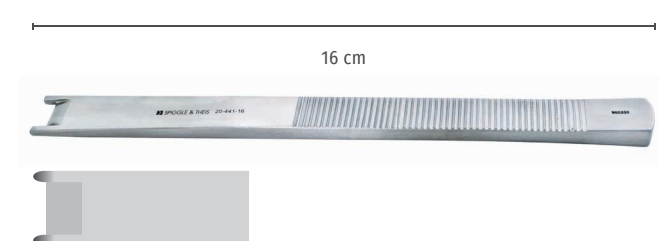

Masing Osteotom, 2 Führungsdorne, 10 mm-Schneide, gerade, 16 cm
Masing osteotome, 2 guards, 10 mm blade, straight, 16 cm

20-441-16

06 Meißel / Osteotome / Hämmer

Chisels / Osteotomes / Mallets



Herberhold Osteotom zur lateralen Osteotomie, 4 mm-Schneide, 18 cm
Herberhold osteotome for lateral osteotomy, 4 mm blade, 18 cm

Art.-Nr./No.	Beschreibung / Description
20-435-01	2 Führungsdorne, gerade double guard, straight
20-435-02	1 Führungsdorn, links gebogen single guard, left curved
20-435-03	1 Führungsdorn, rechts gebogen single guard, right curved



Wurm Osteotom, gerade, mit Schutzsonde, schmale Führungsschiene, Breite 4 mm, 2 mm, 18 cm
Wurm osteotome, straight, with protecting probe, small guide bar, 4 mm width, 2 mm, 18 cm

20-439-01

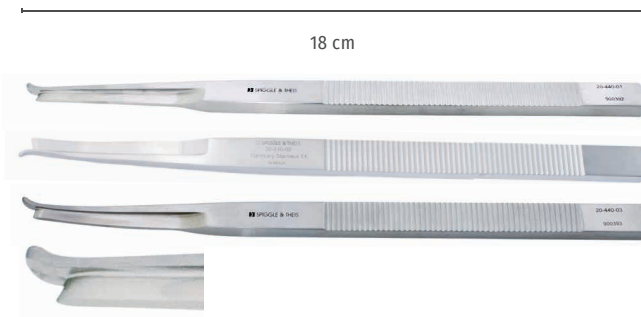

Masing Osteotom zur lateralen Osteotomie, 1 Führungsdorn, 3 mm Schneide, 18 cm
Masing osteotome for lateral osteotomy, single guard, 3 mm blade, 18 cm

Art.-Nr./No.	Beschreibung / Description
20-440-01	gerade / straight
20-440-02	links gebogen / left curved
20-440-03	rechts gebogen / right curved

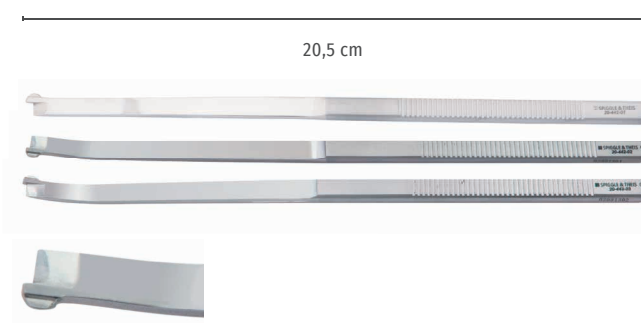

Anderson-Neivert Osteotom zur lateralen Osteotomie, 1 Führungsdorn, 4 mm-Schneide, 20,5 cm
Anderson-Neivert osteotome for lateral osteotomy, single guard, 4 mm blade, 20.5 cm

Art.-Nr./No.	Beschreibung / Description
20-442-01	gerade / straight
20-442-02	links gebogen / left curved
20-442-03	rechts gebogen / right curved



07 Messer

Knives



Skalpelle-Griff / Scalpel handle

Art.-Nr./No.	Nr./No.	Länge / Length (cm)
10-360-03	3	12,5
10-360-04	4	13,5
10-360-07	7	16,0
10-360-33	3L	21,0

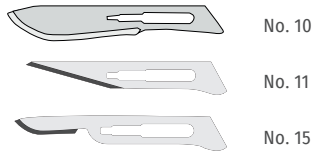

Skalpelle-Klingen, einzeln steril verpackt, 100 Stück

Scalpel blades, single sterile packed, 100 pieces

Art.-Nr./No.	Nr./No.	Beschreibung / Description
10-360-10	10	gerundet / rounded
10-360-11	11	spitz / pointed
10-360-15	15	gerundet / rounded



Cottle Septum-Messer, 14 cm / Cottle septum knife, 14 cm

20-500-13

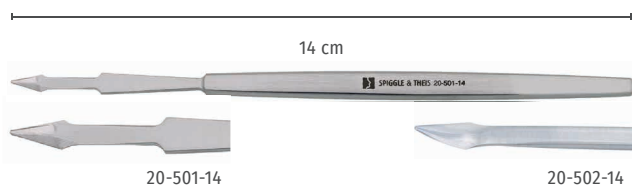

Masing Ritzmesser, 14 cm / Masing pointed knife, 14 cm

Art.-Nr./No.	Beschreibung / Description
20-501-14	mit Kerbe / grooved
20-502-14	glatt / smooth



Freer Septum-Messer, 15 cm / Freer septum knife, 15 cm

20-502-15

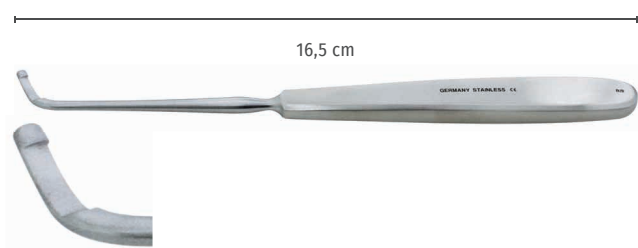

Joseph Rhinoplastikmesser, geknöpft, gewinkelt, 16,5 cm
Joseph rhinoplasty knife, button-end, angled, 16.5 cm

20-503-15



Mikro Handgriff, rund / Micro handle, round

Art.-Nr./No.	Länge / Length (cm)
20-550-10	10
20-550-13	13

Mikro-Klingen, gerade, 25 Stück / Micro blades, straight, 25 pieces

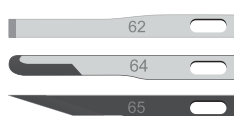

Art.-Nr./No.	Beschreibung / Description
20-551-62	SM62, vierkant / SM62, square
20-551-64	SM64, abgerundet / SM64, rounded
20-551-65	SM65, spitz / SM65, pointed



Panetti Saugraspatorium, gerade, mit Griffplatte, 15 cm, Luer-Lock

Panetti suction raspatory, straight, with finger plate, 15 cm, Luer-Lock

20-000-15



Panetti Septum Messer, 16,5 cm, Luer-Lock

Panetti septum knife, 16.5 cm, Luer-Lock



Art.-Nr.	Größe	Winkel	Beschreibung
Art.-No.	Size (mm)	Angle	Description
20-001-15	5,0	45°	Saugöffnung Winkelinnenseite suction hole in angle
20-002-15	4,3	oval	Saugöffnung links suction hole left
20-003-15	4,3	oval	Saugöffnung rechts suction hole right

08 Wundhaken

Retractors

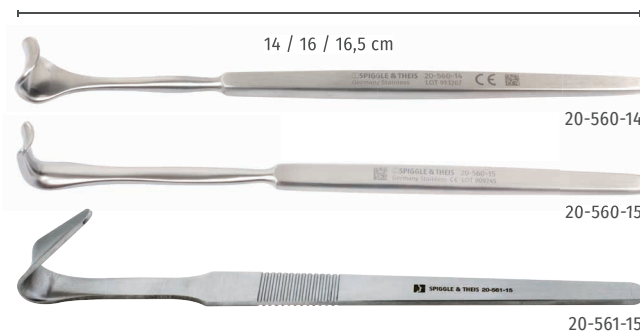

Cottle Nasenflügelhaken

Cottle alar retractor

Art.-Nr./No.	Länge / Length (cm)	Beschreibung / Description
20-560-14	14,0	schmales Blatt / narrow blade
20-560-15	16,5	kurzes Blatt / short blade
20-561-15	16,0	langes Blatt / long blade

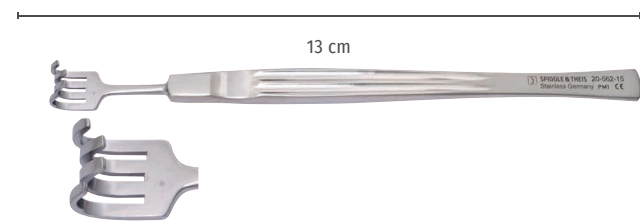

Cottle Nasenhaken, 4 Zähne, stumpf, 13 cm

Cottle nasal hook, 4 prongs, blunt, 13 cm

20-562-15

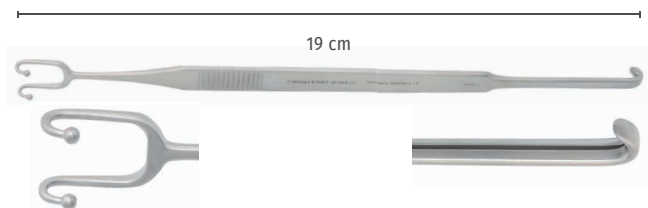

Cottle-Neivert Doppelhaken, 19 cm

Cottle-Neivert double hook, 19 cm

20-564-20



Neivert Draht-Doppelhaken, 18 cm

Neivert wire-shaped retractor, 18 cm

Art.-Nr./No.	Länge / Length (mm)
20-566-18	11,5
20-566-20	13,0



Converse Nasenflügel-Doppelhaken

Converse alar double hook

Art.-Nr./No.	Länge / Length (cm)
20-572-10	11,0, stumpf / blunt
20-573-10	11,5, scharf / sharp



Aufricht Nasenrückenhook

Aufricht nasal retractor

Art.-Nr. Art.-No.	Größe Size (mm)	Länge Length (cm)	Beschreibung Description
20-567-16	50	16,0	
20-568-16	45	15,5	extra fein, Goldgriff extra fine, golden handle

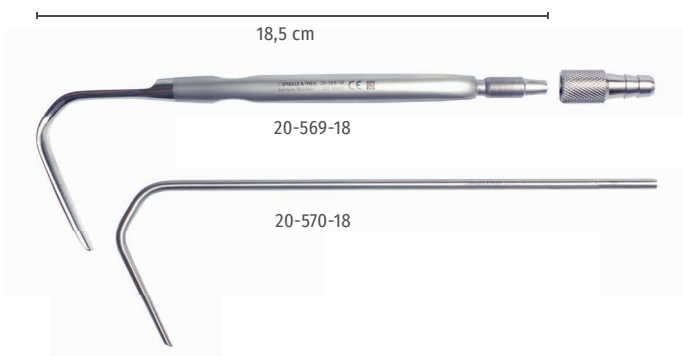

Aufricht Nasenrückenhook 18,5 cm inkl. Saugrohr und Saugadapter / Aufricht nasal retractor 18.5 cm including suction tube and adapter

20-571-18



Aufricht Doppelhook, 11,5 cm / Aufricht double retractor, 11.5 cm

20-570-13

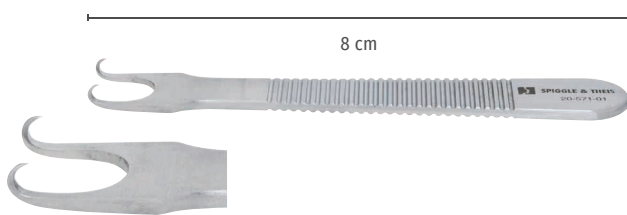

Kilner Wundhäkchen, 2-zinkig, 8 cm / Kilner hook, 2 prongs, 8 cm

Art.-Nr. Art.-No.	Größe Size (mm)	Beschreibung Description
20-571-01	10	scharf / sharp
20-571-02	10	stumpf / blunt
20-571-03	13	scharf / sharp

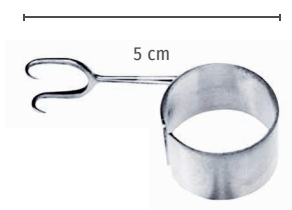

Cottle Fingerring-Häkchen, scharf, 5 cm

Cottle thimble hook, sharp, 5 cm

20-574-06



08 Wundhaken

Retractors

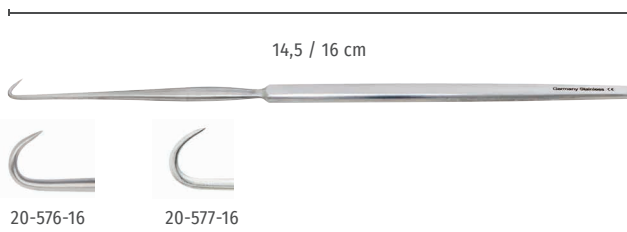

Cottle Hauthäkchen, 1-zinkig, scharf
Cottle skin hook, 1 prong, sharp

Art.-Nr. Art.-No.	Länge Length (cm)	Beschreibung Description
20-576-16	16,0	gewinkelt / angled
20-577-16	14,5	gebogen / curved



Cottle Doppel-Haken, 11 mm, 14,5 cm
Cottle double hook, 11 mm, 14.5 cm

Art.-Nr./No.	Beschreibung / Description
20-579-01	rechts geknöpft, links scharf right prong blunt, left prong sharp
20-579-02	links geknöpft, rechts scharf left prong blunt, right prong sharp

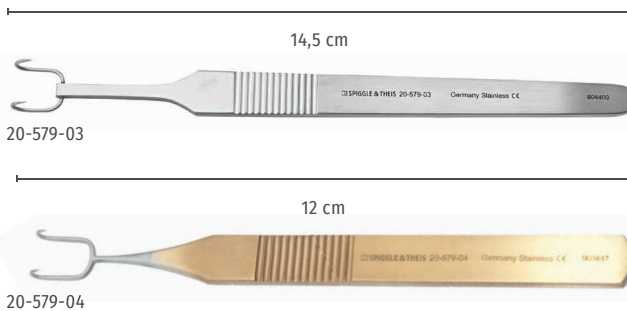

Cottle Doppel-Haken, rechts und links scharf
Cottle double hook, left and right prong sharp

Art.-Nr. Art.-No.	Größe Size (mm)	Länge Length (cm)	Beschreibung Description
20-579-03	11,0	14,5	
20-579-04	10,0	12,0	extra fein, Goldgriff extra fine, golden handle



Freer Wundhäkchen, 2-zinkig, scharf, 15 cm
Freer hook, 2 prongs, sharp, 15 cm

20-580-15

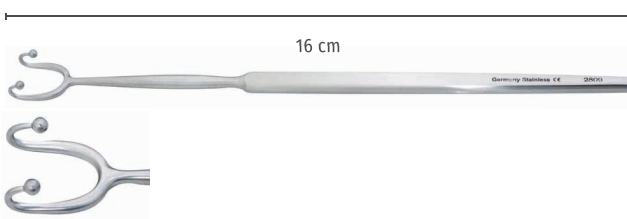

Fomon Nasenflügelhaken, 2-zinkig, stumpf, 12 mm, 16 cm
Fomon alar hook, 2 prongs, blunt, 12 mm, 16 cm

20-584-17

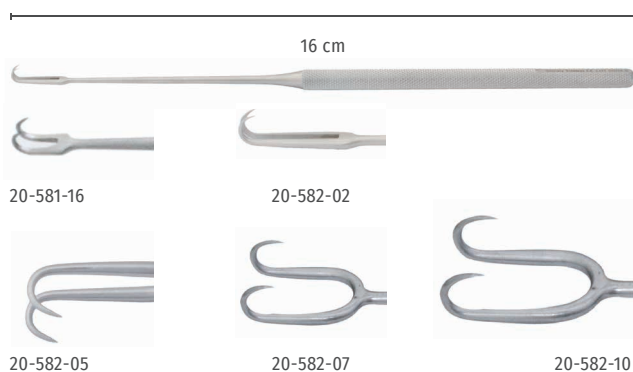

Joseph Doppel-Häkchen, 2-zinkig, scharf, 16 cm
Joseph double hook, 2 prongs, sharp, 16 cm

Art.-Nr. Art.-No.	Hakenbreite Hook width (mm)	Beschreibung Description
20-581-16	5	kurze Biegung short curve
20-582-02	3	
20-582-05	6	
20-582-07	8	
20-582-10	10	

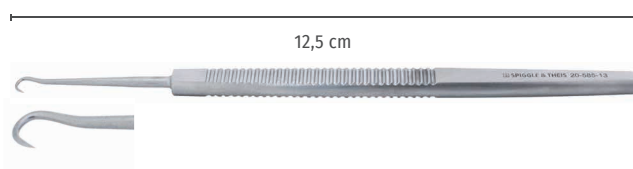

Gillies Hauthäkchen, 1-zinkig, scharf, sehr fein, 12,5 cm
Gillies skin hook, 1 prong, sharp, very fine, 12.5 cm

20-585-13



Cottle Hauthäkchen, 1-zinkig, scharf, fein, 14,5 cm
Cottle skin hook, 1 prong, sharp, fine, 14.5 cm

20-587-15

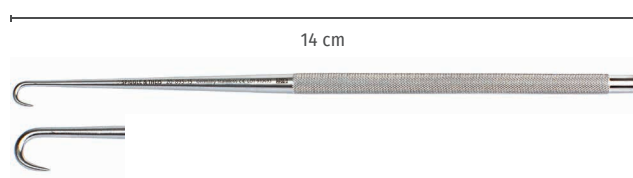

Joseph Wundhaken, 1-zinkig, scharf, 14 cm
Joseph skin hook, 1 prong, sharp, 14 cm

20-895-15



Wundhäkchen, superfein, Goldgriff, 15 cm
Skin hook, very fine, golden handle, 15 cm

Art.-Nr./No.	Beschreibung / Description
20-588-01	ein-zinkig / one prong
20-588-02	zwei-zinkig / two prongs

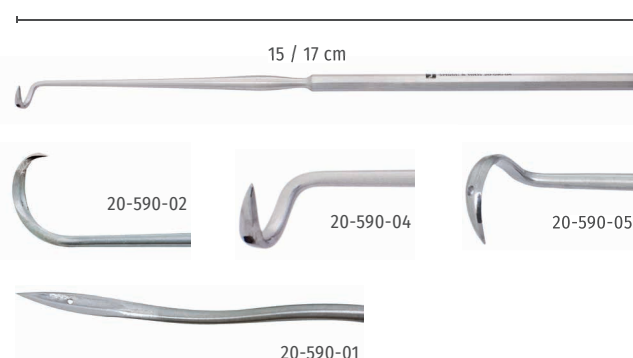

Yankauer Septumnadel / Yankauer septum needle

Art.-Nr. Art.-No.	Länge Length (cm)	Beschreibung Description
20-590-01	17	leicht gebogen, vorwärts slightly curved, forward
20-590-02	17	stark gebogen, rückwärts strongly curved, backward
20-590-04	17	rechts gebogen / right curved
20-590-05	17	links gebogen / left curved



09 Scheren, Premium Line Scissors, Premium Line



**Metzenbaum Schere, Premium Line,
gerade, stumpf-stumpf**
Metzenbaum scissors, Premium Line,
straight, blunt

Premium Line

Art.-Nr. Art.-No.	Länge Length (cm)	Beschreibung Description
20-630-14	14,5	gerade / straight
20-630-18	18,0	gerade / straight
20-630-20	20,0	gerade / straight
20-631-14	14,5	gebogen / curved
20-631-18	18,0	gebogen / curved
20-631-20	20,0	gebogen / curved
20-633-14	14,5	fein, gerade / fine, straight
20-633-18	18,0	fein, gerade / fine, straight
20-633-20	20,0	fein, gerade / fine, straight
20-634-14	14,5	fein, gebogen / fine, curved
20-634-18	18,0	fein, gebogen / fine, curved
20-634-20	20,0	fein, gebogen / fine, curved

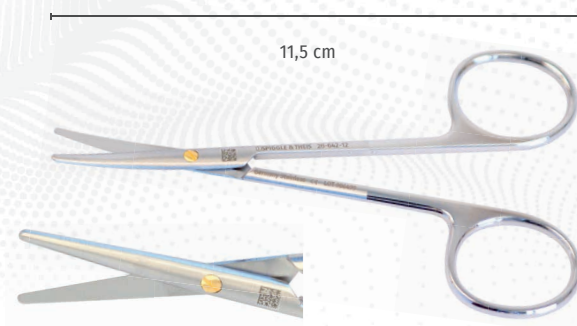

**Metzenbaum-Baby Schere, Premium Line,
stumpf-stumpf, 11,5 cm**
Metzenbaum baby scissors, Premium Line,
blunt, 11.5 cm

Premium Line

Art.-Nr./No.	Beschreibung / Description
20-646-12	gerade / straight
20-642-12	gebogen / curved



**Reynolds Schere, Premium Line, gebogen,
stumpf-stumpf, verjüngte Spitze**
Reynolds scissors, Premium Line, curved,
blunt-blunt, tapered tip

Premium Line

Art.-Nr.	Länge (cm)
20-635-15	15,0
20-635-18	18,0

09 Scheren, Premium Line

Scissors, Premium Line



**Joseph Schere, Premium Line,
spitz-spitz, 14,5 cm**
Joseph scissors, Premium Line,
pointed, 14.5 cm

Premium Line

Art.-Nr./No.	Beschreibung / Description
20-640-14	gerade / straight
20-641-14	gebogen / curved

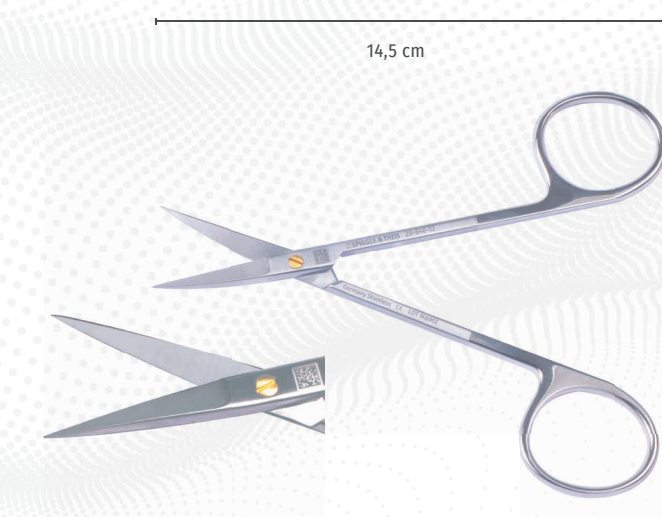

Schere, Premium Line, spitz/spitz, 11,5 cm
Scissors, Premium Line, pointed, 11.5 cm

Premium Line

Art.-Nr./No.	Beschreibung / Description
20-647-12	gerade / straight
20-648-12	gebogen / curved

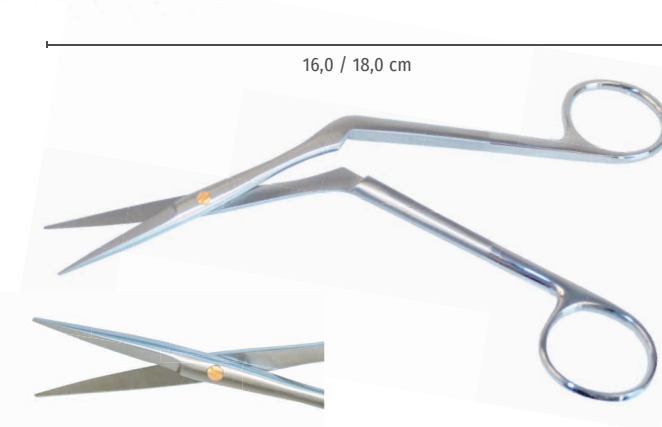

**Heymann Nasenschere, Premium Line,
gezahnt, gerade**
Heymann nasal scissors, Premium Line,
serrated, straight

Premium Line

Art.-Nr. Art.-No.	Länge Length (cm)	Beschreibung Description
20-650-16	16,0	fein / fine
20-651-18	18,0	kräftig / robust



09 Scheren

Scissors



Joseph Schere, spitz-spitz, 14,5 cm
Joseph scissors, pointed, 14.5 cm

Art.-Nr./No.	Beschreibung / Description
20-600-14	gerade / straight
20-601-14	gebogen / curved

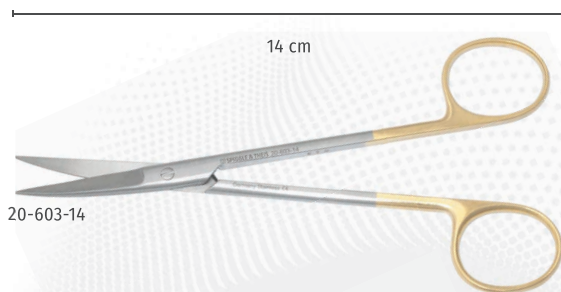

Joseph Schere, Hartmetall, spitz-spitz, 14,5 cm
Joseph scissors, tungsten carbide, pointed, 14.5 cm

Art.-Nr./No.	Beschreibung / Description
20-602-14	gerade / straight
20-603-14	gebogen / curved

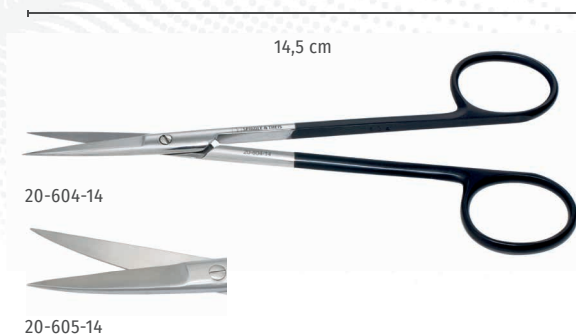
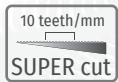

Joseph Schere, supercut, spitz-spitz, 14,5 cm
Joseph scissors, supercut, pointed, 14.5 cm

Art.-Nr./No.	Beschreibung / Description
20-604-14	gerade / straight
20-605-14	gebogen / curved



Metzenbaum-Fino Schere, spitz-spitz, gebogen
Metzenbaum-Fino scissors, pointed, curved

Art.-Nr./No.	Länge / Length (cm)
20-607-18	18,0
20-607-20	20,5

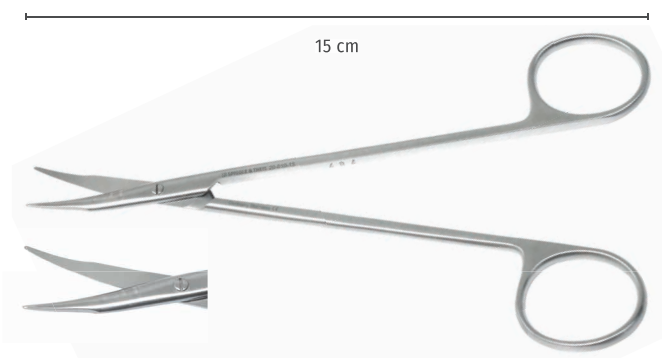

Reynolds Schere, stumpf-stumpf, gebogen, verjüngte Spitzen, 15 cm
Reynolds scissors, blunt-blunt, curved, tapered tips, 15 cm

20-610-15



Reynolds Schere, stumpf-stumpf, supercut, gebogen, 15,5 cm
Reynolds scissors, blunt, supercut, curved, 15.5 cm

20-611-15

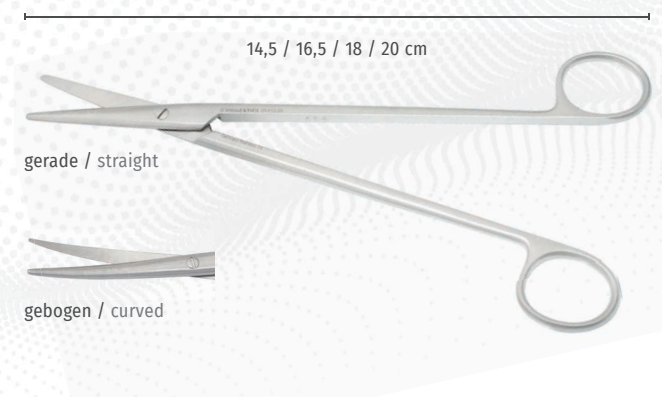

Metzenbaum Schere, stumpf-stumpf, fein
Metzenbaum scissors, blunt, fine

Art.-Nr. Art.-No.	Länge Length (cm)	Beschreibung Description
20-612-14	14,5	gebogen / curved
20-612-15	14,5	gerade / straight
20-612-16	16,5	gerade / straight
20-612-18	18,0	gerade / straight
20-612-20	20,0	gerade / straight
20-614-15	14,5	gebogen / curved
20-614-18	18,0	gebogen / curved
20-614-20	20,5	gebogen / curved



Metzenbaum Schere, Hartmetall, stumpf-stumpf, fein
Metzenbaum scissors, tungsten carbide, blunt, fine

Art.-Nr. Art.-No.	Länge Length (cm)	Beschreibung Description
20-613-15	14,5	gerade / straight
20-613-18	18,0	gerade / straight
20-613-20	20,5	gerade / straight
20-615-15	14,5	gebogen / curved
20-615-18	18,0	gebogen / curved
20-615-20	20,5	gebogen / curved



09 Scheren

Scissors



Metzenbaum Schere, supercut, stumpf-stumpf, fein, 14,5 cm
Metzenbaum scissors, supercut, blunt, fine, 14.5 cm

Art.-Nr./No.	Beschreibung / Description
20-616-15	gebogen / curved
20-618-15	gerade / straight



Metzenbaum Schere, duracut-ceramic, gebogen, stumpf-stumpf, fein, 14,5 cm
Metzenbaum scissors, duracut ceramic, curved, blunt, fine, 14.5 cm

20-617-15



Kilner Rhinoplastikschere, flache Spitze, stumpf, gebogen, 13,5 cm
Kilner rhinoplasty scissors, flat end, blunt, curved, 13.5 cm

20-620-14



Kilner Rhinoplastikschere, supercut, flache Spitze, stumpf, gebogen, 13,5 cm
Kilner rhinoplasty scissors, supercut, flat end, blunt, curved, 13.5 cm

20-621-14



**Kilner Rhinoplastikscherer, Hartmetall,
flache Spitze, stumpf-stumpf, gebogen**
Kilner rhinoplasty scissors, tungsten carbide,
flat end, blunt, curved

Art.-Nr./No.	Länge / Length (cm)
20-622-13	13,5
20-622-15	15,0

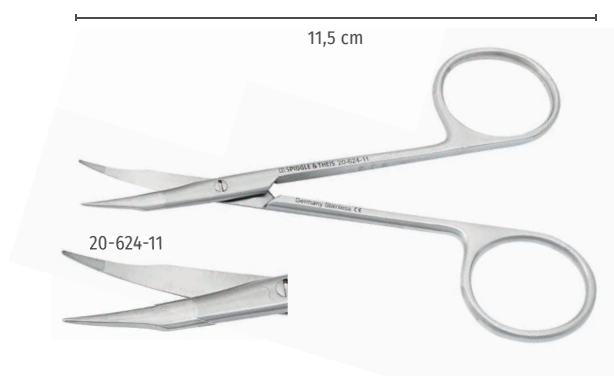

Stevens Gefäßschere, verjüngte Spitzen, 11,5 cm
Stevens vascular scissors, small tips, blunt, 11.5 cm

Art.-Nr./No.	Beschreibung / Description
20-623-11	gerade / straight
20-624-11	gebogen / curved
20-625-11	gebogen, supercut / curved, supercut



**Siegert Unterminierscherer, verjüngte Spitzen, außen/innen
scharf, gebogen, duracut-ceramic, 11,5 cm**
Siegert undermining scissors, tapered tips,
outside/inside sharp, curved, duracut-ceramic, 11.5 cm

20-626-11



09 Scheren

Scissors

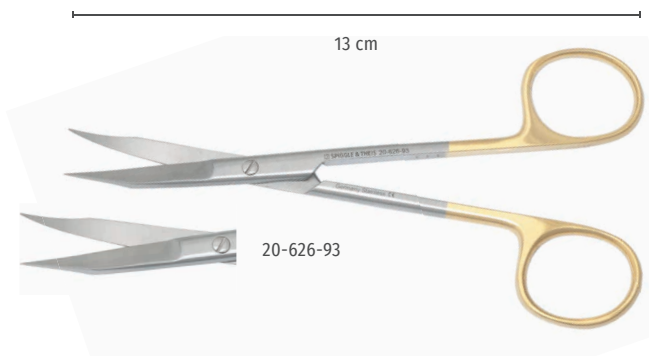

Goldman-Fox Schere, verjüngte Spitzen, gebogen, unteres Blatt gezahnt, 13 cm
Goldman-Fox scissors, small tips, curved, bottom blade serrated, 13 cm

Art.-Nr./No.	Beschreibung / Description
20-626-93	Hartmetall / tungsten carbide
20-627-13	supercut
20-628-13	duracut ceramic



Schere, gerade, spitz-spitz
Scissors, straight, pointed

Art.-Nr. Art.-No.	Länge Length (cm)	Beschreibung Description
10-530-10	10,5	sehr fein / very fine
10-533-12	11,5	

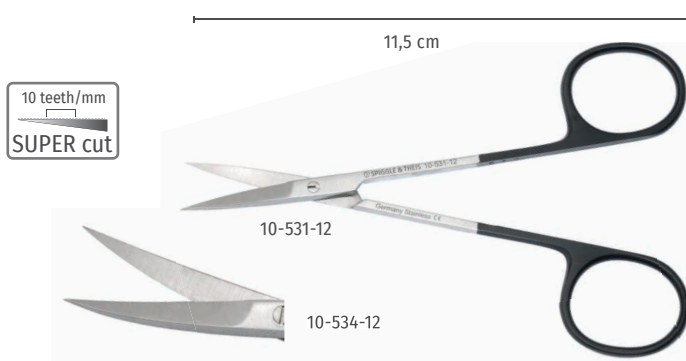

Schere, supercut, spitz-spitz, sehr fein, 11,5 cm
Scissors, supercut, pointed, very delicate, 11.5 cm

Art.-Nr./No.	Beschreibung / Description
10-531-12	gerade / straight
10-534-12	gebogen / curved



Schere, gebogen, spitz-spitz, extra fein, 10,5 cm
Scissors, curved, pointed, very fine, 10.5 cm

10-536-10

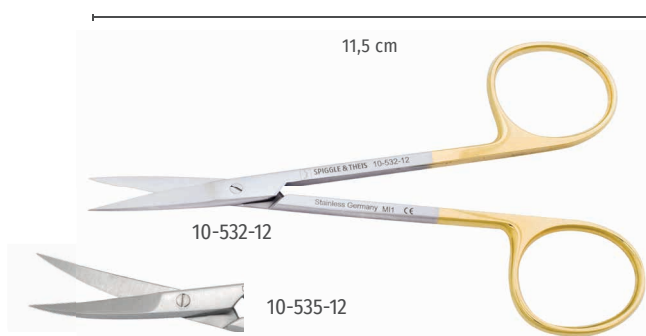

Schere, Hartmetall, spitz-spitz, 11,5 cm
Scissors, tungsten carbide, pointed, 11.5 cm

Art.-Nr./No.	Beschreibung / Description
10-532-12	gerade / straight
10-535-12	gebogen / curved

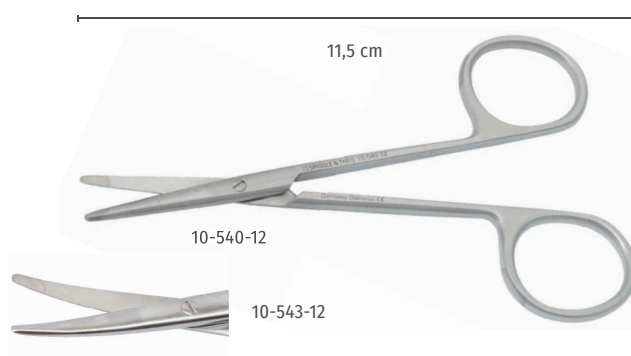

Schere, stumpf-stumpf, 11,5 cm
Scissors, blunt, 11.5 cm

Art.-Nr./No.	Beschreibung / Description
10-540-12	gerade / straight
10-543-12	gebogen / curved

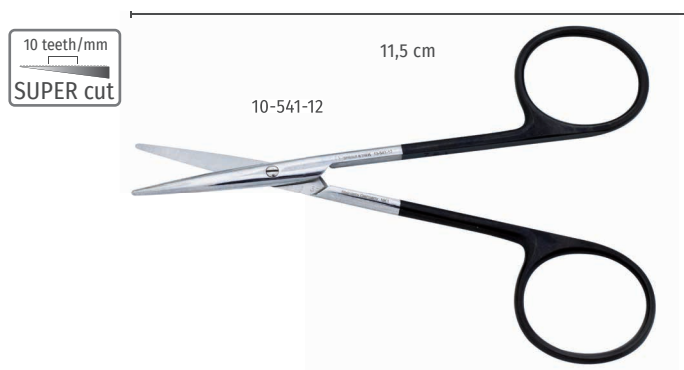

Schere, supercut, stumpf-stumpf, 11,5 cm
Scissors, supercut, blunt, 11.5 cm

Art.-Nr./No.	Beschreibung / Description
10-541-12	gerade / straight
10-544-12	gebogen / curved



09 Scheren

Scissors

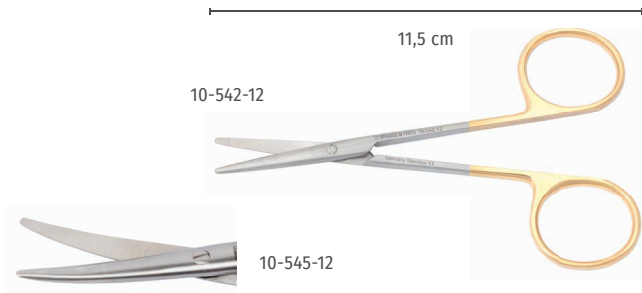

Schere, Hartmetall, stumpf-stumpf, 11,5 cm

Scissors, tungsten carbide, blunt, 11.5 cm

Art.-Nr./No.	Beschreibung / Description
10-542-12	gerade / straight
10-545-12	gebogen / curved

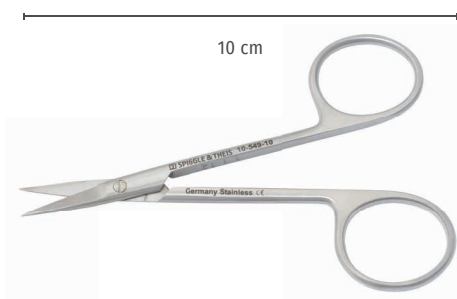

Schuknecht Drahtschneidescherchen, gezahnt, gerade, 10 cm

Schuknecht wire cutting scissors, serrated, straight, 10 cm

10-549-10



Universalschere, gebogen, spitz-stumpf, 13 cm

Universal scissors, curved, pointed-blunt, 13 cm

10-550-13



Walter Schere, abgewinkelt / Walter scissors, angled

Art.-Nr./No.	Beschreibung / Description
20-630-15	14,5 cm, Standardausführung 14.5 cm standard version
20-630-10	Vergoldeter Griff, 10 cm / golden handle



Cottle Nasenflügelschere, stark gebogen, 12 cm
Cottle lower lateral scissors, strongly curved, 12 cm

20-632-12

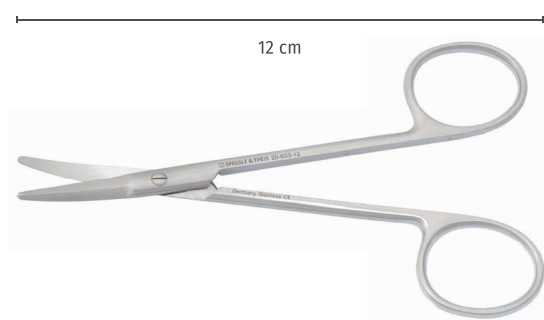

Fomon Nasenschere, gebogen, Doppelblatt, 12 cm
Fomon nasal scissors, curved, double blade, 12 cm

20-633-12



09 Scheren

Scissors



Cottle Nasenschere, gezahnt, gewinkelt, kräftig, 16 cm
Cottle lower lateral scissors, serrated, angled, heavy, 16 cm

20-638-16

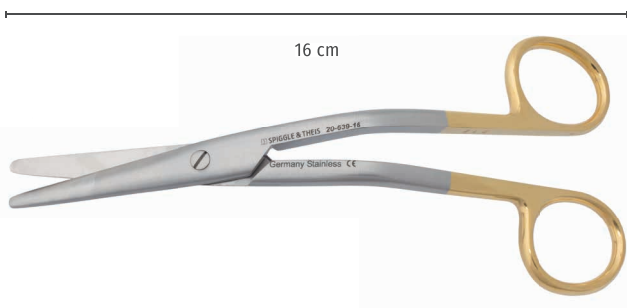

Cottle Nasenschere, gewinkelt, kräftig, Hartmetall, 16 cm
Cottle nasal scissors, angled, strong, tungsten carbide, 16 cm

20-639-16

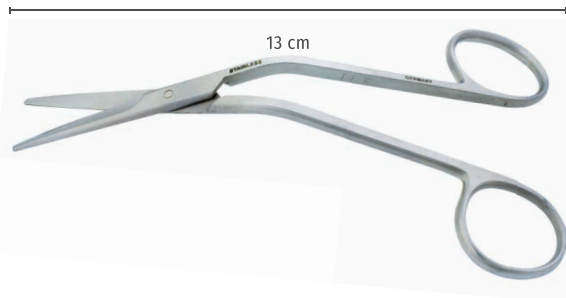

Fomon Nasenschere, gezahnt, gewinkelt, fein, 13 cm
Fomon dorsal scissors, serrated, angled, fine, 13 cm

20-635-13



Heymann Nasenschere, gezahnt, gerade
Heymann nasal scissors, serrated, straight

Art.-Nr. Art.-No.	Länge Length (cm)	Beschreibung Description
20-680-16	16	fein / fine
20-683-18	18	kräftig / strong



Heymann Nasenschere, gezahnt, gebogen, fein, 16 cm
Heymann nasal scissors, serrated, curved, fine, 16 cm

Art.-Nr./No.	Beschreibung / Description
20-681-16	links gebogen / left curved
20-682-16	rechts gebogen / right curved

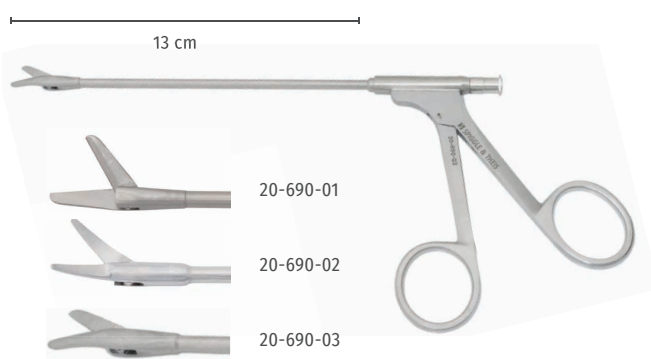

Conchotomie Schere, gezahnt, Rohrschaft, mit Spülkanal, 13 cm
Nasal conchotomy scissors, serrated, tubular model, with irrigation channel, 13 cm

Art.-Nr./No.	Beschreibung / Description
20-690-01	gerade / straight
20-690-02	links gebogen / left curved
20-690-03	rechts gebogen / right curved

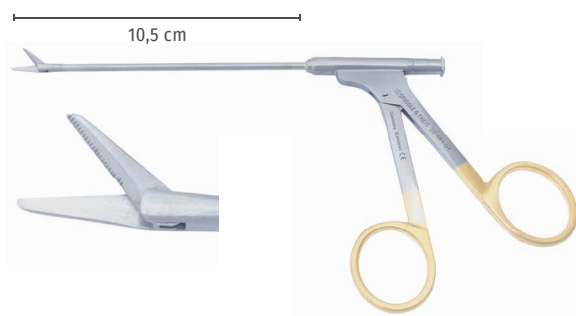

Weber Nasenschere, extra fein, gerade, mit Spülkanal, 10,5 cm
Weber nasal scissors, very fine, straight, with irrigation channel, 10.5 cm

20-691-01



Mikro-Gefäßschere, spitz-spitz, gebogen, 11 cm
Micro vascular scissors, pointed, curved, 11 cm

20-696-11



10 Pinzetten / Nadelhalter

Forceps / Needle Holders

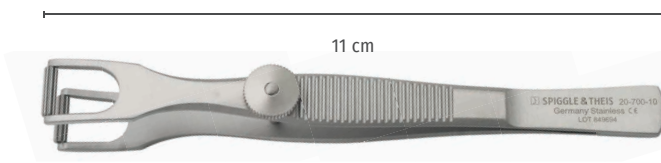

Cottle Columella-Klemme, 11 cm
Cottle columella forceps, 11 cm

20-700-10



Cottle Columella-Klemme für Kinder, 8,5 cm
Cottle columella forceps for children, 8.5 cm

20-701-08



Herberhold Hautfazzzange, 2:2 Zähne, extra fein, 13,5 cm
Herberhold tissue forceps, 2:2 teeth, extra fine, 13.5 cm

20-705-14

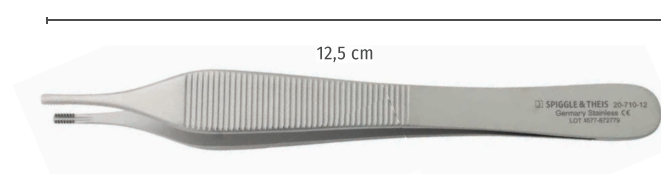

Adson-Brown Pinzette, 7:8 Zähne, 12,5 cm
Adson-Brown forceps, 7:8 teeth, 12.5 cm

20-710-12

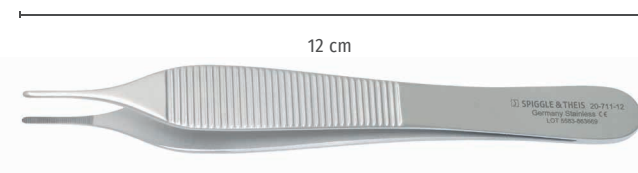

Adson Pinzette, anatomisch, 12 cm
Adson dressing forceps, anatomical, 12 cm

20-711-12



Pinzette nach Bishop-Harmon, 1:2 Zähne, Länge 8,5 cm
Forceps by Bishop-Harmon, 1:2 teeth, length 8.5 cm

Art.-Nr./No.	Spitze / Tip
10-506-05	0,5
10-506-10	1,0

10 Pinzetten / Nadelhalter

Forceps / Needle Holders

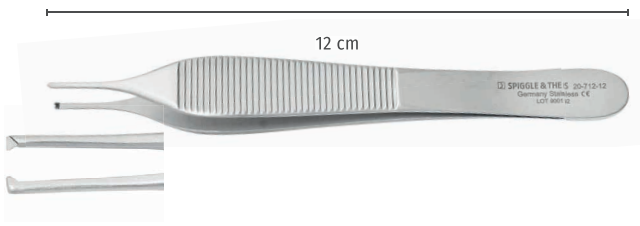

Adson Pinzette, chirurgisch, 1:2 Zähne, 12 cm
Adson dressing forceps, 1:2 teeth, 12 cm

20-712-12

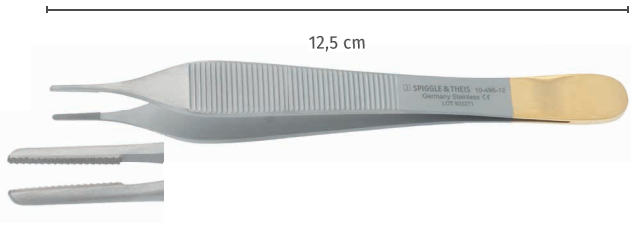

Adson Pinzette, Hartmetall, anatomisch, 12,5 cm
Adson dressing forceps, tungsten carbide, anatomical, 12.5 cm

10-496-12

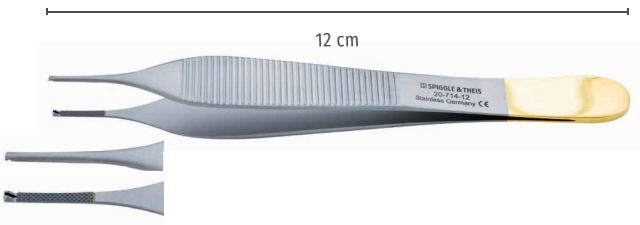

Adson Pinzette, chirurgisch, Hartmetall, 1:2 Zähne, 12 cm
Adson dressing forceps, tungsten carbide, 1:2 teeth, 12 cm

20-714-12

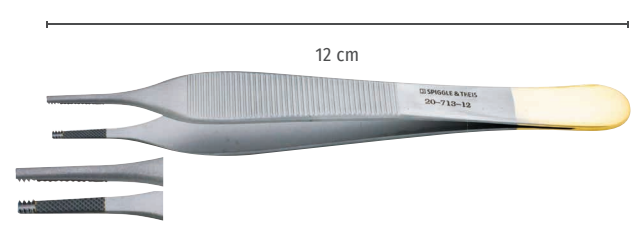

Adson-Brown-Pinzette, Hartmetall, 7:8 Zähne, 12 cm
Adson-Brown dressing forceps, tungsten carbide, 7:8 teeth, 12 cm

20-713-12

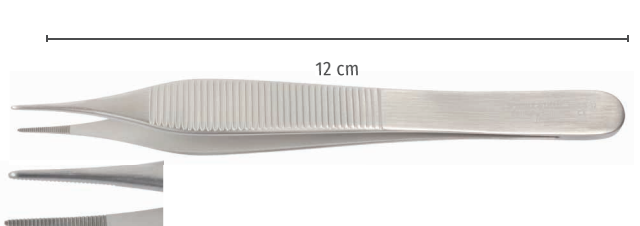

Mikro-Adson-Pinzette, anatomisch, 12 cm
Micro Adson forceps, anatomical, 12 cm

20-715-12

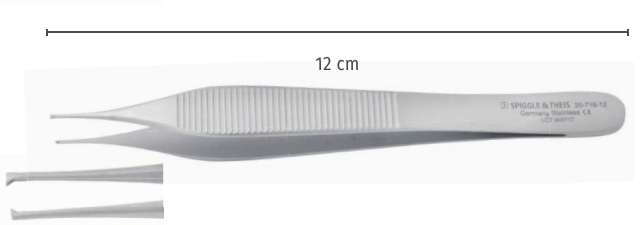

Mikro-Adson-Pinzette, chirurgisch, 1:2 Zähne, 12 cm
Micro Adson forceps, 1:2 teeth, 12 cm

20-716-12

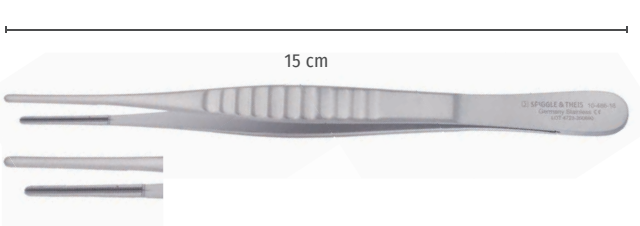

DeBakey Pinzette, atraumatisch, gerade, 15 cm
DeBakey dressing forceps, atraumatic, straight, 15 cm

Art.-Nr./No.	Spitze / Tip
10-486-16	2,0
10-487-16	1,5



10 Pinzetten / Nadelhalter

Forceps / Needle Holders

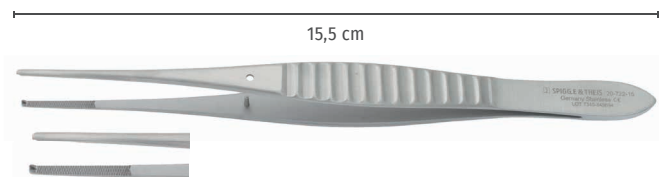

Gillies Gewebepinzette, gerieft mit 1:2 Zähnen, 15,5 cm
Gillies tissue forceps, serrated with 1:2 teeth, 15.5 cm

20-722-15

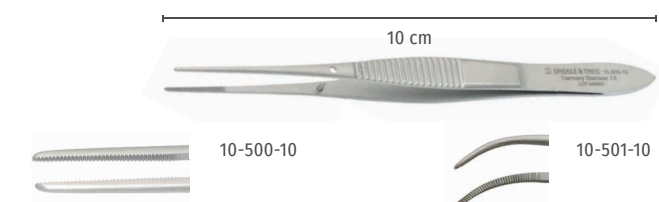

Graefe Pinzette, anatomisch, 0,7 mm, 10 cm
Graefe dressing forceps, anatomical, 0.7 mm, 10 cm

Art.-Nr./No.	Beschreibung / Description
10-500-10	gerade / straight
10-501-10	gebogen / curved

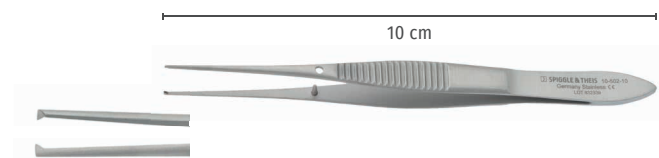

Graefe Pinzette, chirurgisch, 1:2 Zähne, gerade, 0,7 mm, 10 cm
Graefe dressing forceps, 1:2 teeth, straight, 0.7 mm, 10 cm

10-502-10

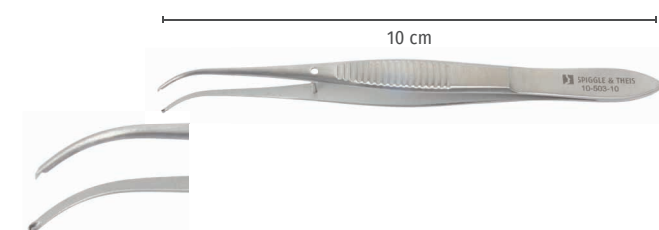

Graefe Pinzette, chirurgisch, 1:2 Zähne, gebogen, 0,7 mm, 10 cm
Graefe dressing forceps, 1:2 teeth, curved, 0.7 mm, 10 cm

10-503-10

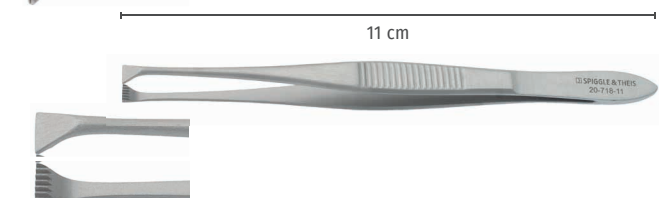

Graefe Mäusezähnnchen Pinzette, 7:8 Zähne, 11 cm
Graefe tissue forceps, 7:8 teeth, 11 cm

20-718-11

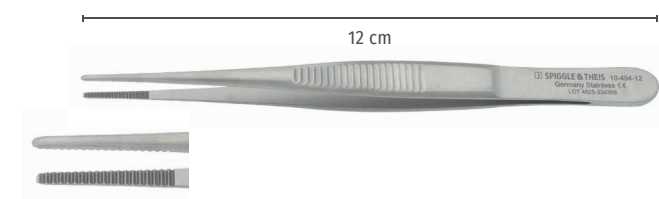

Pinzette, anatomisch, gerade, 1,3 mm, 12 cm
Dressing forceps, anatomical, straight, 1.3 mm, 12 cm

10-494-12

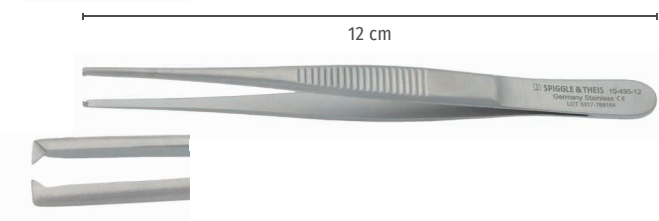

Pinzette, chirurgisch, 1:2 Zähne, gerade, 1,5 mm, 12 cm
Dressing forceps, surgical, 1:2 teeth, straight, 1.5 mm, 12 cm

10-495-12



Cottle Nasenpinzette, bajonett, mit Schraube, gerieft mit Dornen, 14,5 cm
Cottle lower lateral forceps, bayonet, with screw, serrated with thorns, 14.5 cm

20-720-14

10 Pinzetten / Nadelhalter

Forceps / Needle Holders

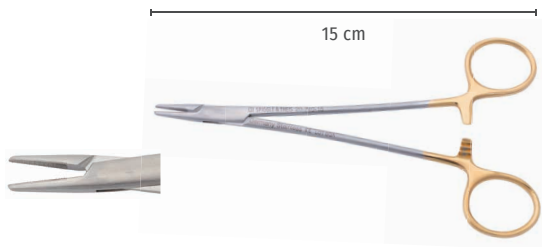

Crile-Wood Nadelhalter, Hartmetall, 15 cm
Crile-Wood needleholder, tungsten carbide, 15 cm

20-740-15

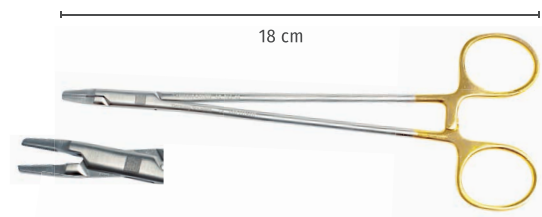

Crile-Wood Ryder Nadelhalter, Hartmetall, verjüngte Spitzen 18 cm
Crile-Wood Ryder needleholder, tungsten carbide, small ends, 18 cm

40-745-18

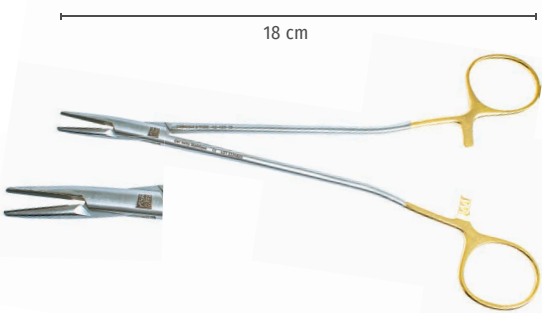

Sarot Nadelhalter, Hartmetall, 18 cm
Sarot needle holder, tungsten carbide, 18 cm

40-480-18

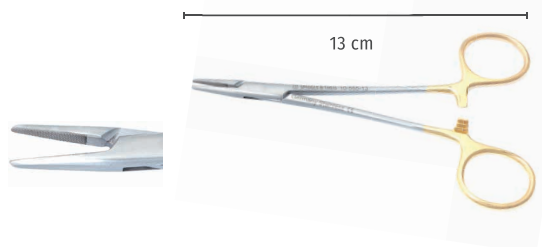

Halsey Nadelhalter, Hartmetall, fein, 13 cm
Halsey needle holder, tungsten carbide, delicate, 13 cm

10-555-13

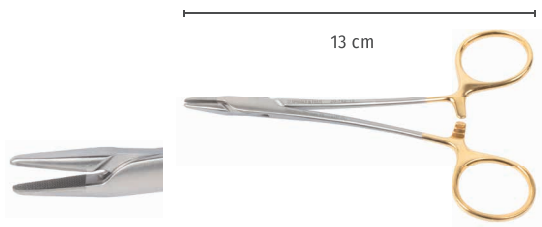

Neivert Nadelhalter, Hartmetall, fein, 13 cm
Neivert needle holder, tungsten carbide, fine, 13 cm

20-742-13

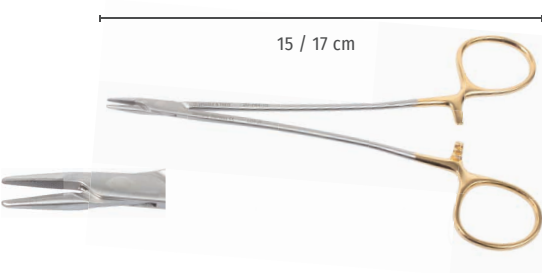

Senning Nadelhalter, Hartmetall, extra schlank
Senning needle holder, tungsten carbide, slender shape

Art.-Nr./No.	Länge / Length (cm)
20-744-15	15
20-744-17	17



10 Pinzetten / Nadelhalter

Forceps / Needle Holders

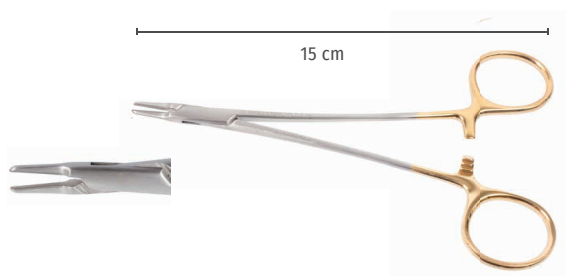

Mikro-Ryder Nadelhalter, Hartmetall, verjüngte Spitzen, 15 cm
Micro-Ryder needle holder, tungsten carbide, small ends, 15 cm

20-745-15

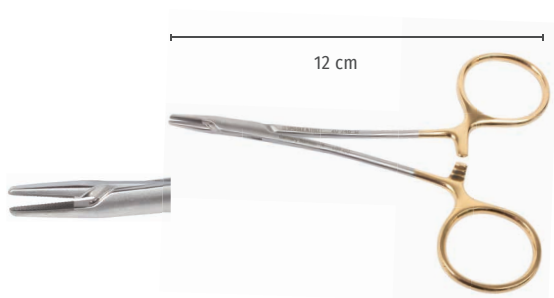

Converse Nadelhalter, Hartmetall, sehr fein, 12 cm
Converse needle holder, tungsten carbide, very fine, 12 cm

20-746-12

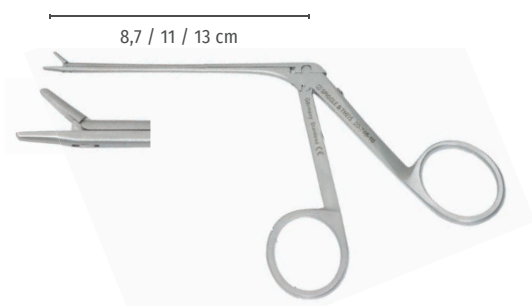

Masing Nadelhalter, glattes Maul, abgewinkelter Daumenring
Masing needle holder, smooth jaws, angled thumb ring

Art.-Nr./No.	AL / WL (cm)
20-748-10	8,7
20-748-11	11,0
20-748-13	13,0



Castroviejo Mikro-Nadelhalter, gerade, glatt, flache Federgriffe, mit Sperre, 9 cm
Castroviejo micro needle holder, straight, smooth, flat type handles, with ratchet, 9 cm

20-764-09

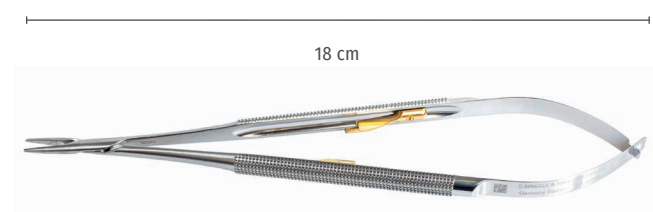

Stream Line Mikro-Nadelhalter gerade, diamantiert, runde Federgriffe, Hochgl., Sperre, vergold., Maul 0,8mm, 18cm
Stream Line micro needle holder, straight, diamond tip, round type handles, golden, with ratchet, tip 0.8 mm, 18 cm

20-889-18

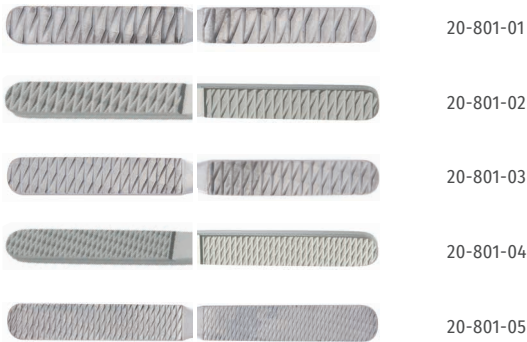
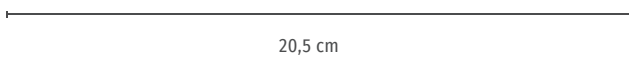

Fomon Nasenraspel, Hartmetall, doppelseitig, besonders flach, 20,5 cm
Fomon nasal rasp, tungsten carbide, double ended, very flat, 20.5 cm

Art.-Nr./No.	Beschreibung / Description
20-801-01	Körnung 1/2 = grob / grain size 1/2 = coarse
20-801-02	Körnung 3/4 = grob/mittel grain size 3/4 = coarse/medium
20-801-03	Körnung 5/6 = mittel / grain size 5/6 = medium
20-801-04	Körnung 7/8 = mittel/fein grain size 7/8 = medium/fine
20-801-05	Körnung 9/10 = fein / grain size 9/10 = fine

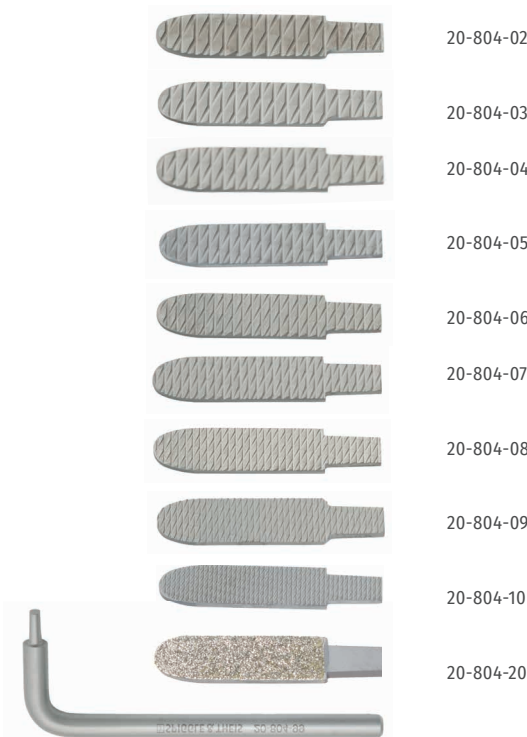
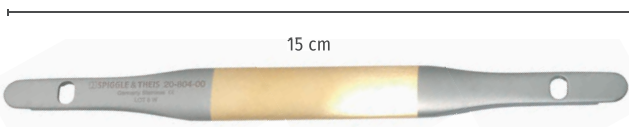

Handgriff, doppellendig, für Hartmetall
Rasplplatten 20-804-01 bis -10, 15 cm
Handle, double ended, for tungsten carbide
rasps 20-804-01 up to -10, 15 cm

20-804-00

Raspeleinsatz, Hartmetall
Insert for rasp, tungsten carbide

Art.-Nr./No.	Körnung / Grain Size
20-804-01	1 = sehr grob / 1 = very coarse
20-804-02	2 = grob / 2 = coarse
20-804-03	3 = mittel-grob / 3 = medium-coarse
20-804-04	4 = mittel / 4 = medium
20-804-05	5 = mittel / 5 = medium
20-804-06	6 = mittel-fein / 6 = medium-fine
20-804-07	7 = fein / 7 = fine
20-804-08	8 = fein / 8 = fine
20-804-09	9 = sehr fein / 9 = very fine
20-804-10	10 = extra fein / 10 = extra fine
20-804-20	Diamant / diamond

Schlüssel für "Handgriff, doppellendig" (20-804-00)
Key for "handle, double ended" (20-804-00)

20-804-99



11 Raspeln

Rasps



Maltz Nasenraspel, Hartmetall, mit Blutrinne, einseitig, 17,5 cm
Maltz nasal rasp, tungsten carbide, with blood groove, single ended, 17.5 cm

Art.-Nr./No.	Beschreibung / Description
20-805-01	auf Zug schneidend / down-cutting
20-805-02	auf Druck schneidend / up-cutting

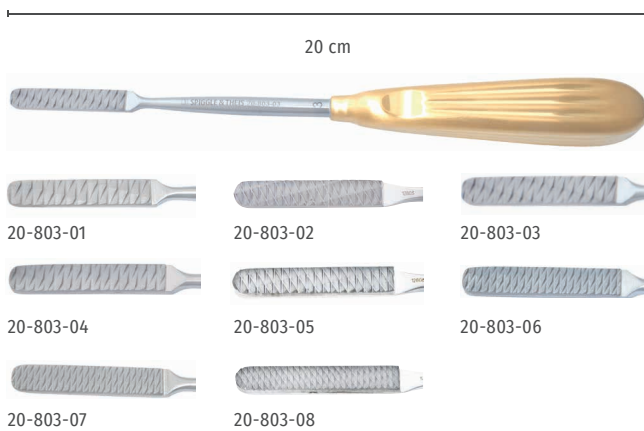

Parkes Nasenraspel, Hartmetall, einseitig, 20 cm
Parkes nasal rasp, tungsten carbide, single ended, 20 cm

Art.-Nr./No.	Körnung / Grain Size
20-803-01	1 = grob / 1 = coarse
20-803-02	2 = grob / 2 = coarse
20-803-03	3 = grob / 3 = coarse
20-803-04	4 = mittel / 4 = medium
20-803-05	5 = mittel / 5 = medium
20-803-06	6 = mittel / 6 = medium
20-803-07	7 = fein / 7 = fine
20-803-08	8 = fein / 8 = fine

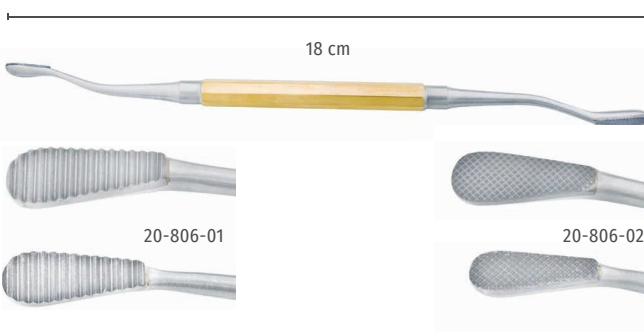

Miller Nasenraspel, Hartmetall, doppelseitig, 18 cm
Miller nasal rasp, tungsten carbide, double ended, 18 cm

Art.-Nr./No.	Beschreibung / Description
20-806-01	quergerieft / cross cut
20-806-02	karogerieft / square cut

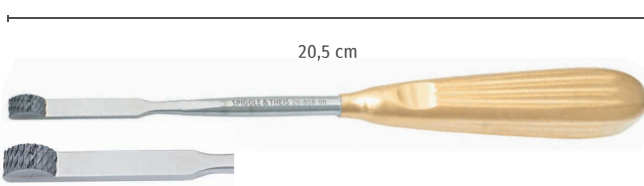

Aufricht Glabella Raspel, Hartmetall, einseitig, 20,5 cm
Aufricht glabella rasp, tungsten carbide, single ended, 20.5 cm
20-808-00

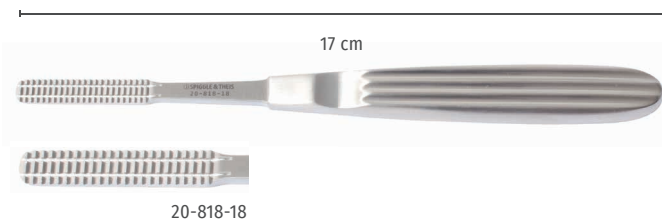

Maltz Nasenraspel, mit 2 Blutrinnen, einseitig, 17 cm
Maltz nasal rasp, with 2 blood grooves, single ended, 17 cm

Art.-Nr./No.	Beschreibung / Description
20-818-18	auf Zug schneidend / down-cutting
20-819-18	auf Druck schneidend / up-cutting

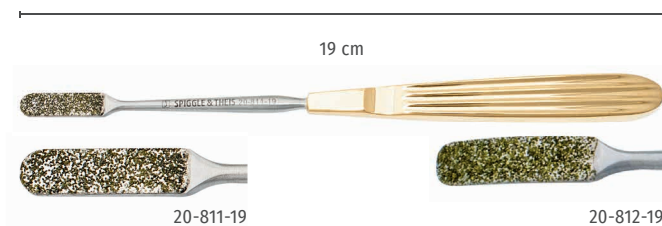

Cottle Nasenraspel, Diamant, einseitig, goldener Griff, 19 cm
Cottle nasal rasp, diamond, single ended, golden handle, 19 cm

Art.-Nr./No.	Beschreibung / Description
20-811-19	gerade / straight
20-812-19	gebogen / curved

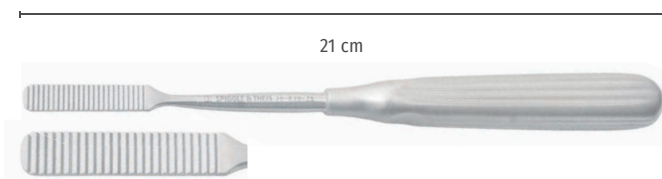

Cottle Nasenraspel, einseitig, auf Zug schneidend, 21 cm
Cottle nasal rasp, single ended, down cutting, 21 cm

20-820-21



Masing Nasenraspel, doppelseitig, 21,5 cm
Masing nasal rasp, double ended, 21.5 cm

Art.-Nr./No.	Beschreibung / Description
20-815-21	feiner Hieb / fine cut
20-816-21	grober Hieb / coarse cut

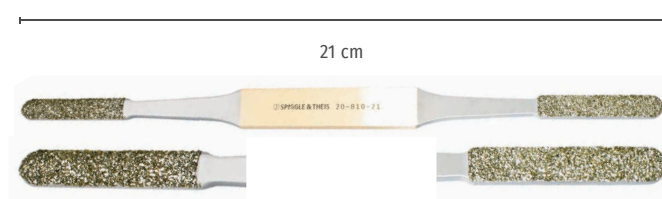

Fomon Nasenraspel, Diamant, goldener Griff, doppelseitig, 21 cm
Fomon nasal rasp, diamond, golden handle, double ended, 21 cm

20-810-21

11 Raspeln

Rasps

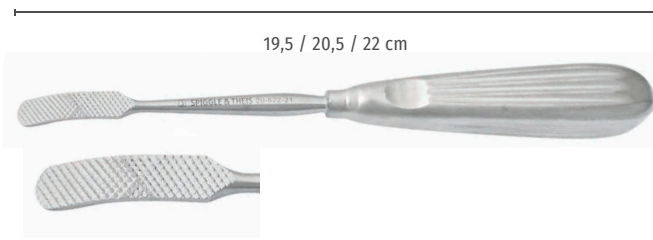

Aufricht Glabella Raspel, einseitig Aufrecht glabella rasp, single ended

Art.-Nr. Art.-No.	Länge Length (cm)	Beschreibung Description
20-822-21	19,5	auf Zug und Druck schneidend up and down cutting
20-823-21	20,5	auf Zug schneidend down cutting
20-824-21	22,0	auf Druck schneidend up cutting

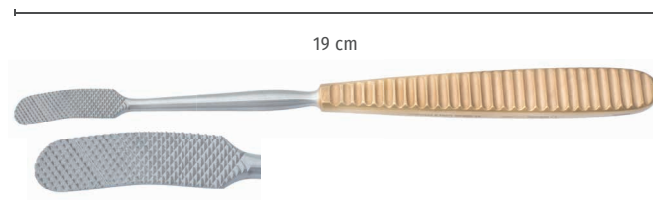

Aufricht Glabella Raspel, einseitig, auf Druck und Zug schneidend, vergoldeter Griff, 19 cm Aufrecht glabella rasp, single ended, up and down cutting, golden handle, 19 cm

20-825-18



Anderson Nasenraspel, einseitig, 30° schräg gezahnt, 21 cm Anderson nasal rasp , single ended, 30° bevelled serrated, 21 cm

Art.-Nr./No.	Beschreibung / Description
20-826-21	auf Zug schneidend down-cutting
20-827-21	auf Druck schneidend up-cutting

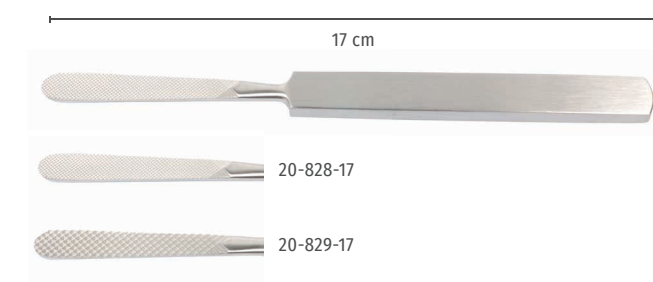

Joseph Nasenraspel, einseitig / Joseph nasal rasp, single ended

Art.-Nr./No.	Länge / Length (cm)	Beschreibung / Description
20-828-17	17	fein / fine
20-829-17	17	grob / coarse



Kleinert-Kutz Nasenraspel, doppelendig, vierseitig, mit je 2 Seiten fein (flach) und grob (konvex/flach) gerieft, 21,5 cm Kleinert-Kutz nasal rasp, double ended, 4-sided, with 2 sides each fine (flat) and coarse (convex/flat), serrated, 21.5 cm

20-830-21



Aufricht Nasenfraktur-Elevatorium, gerade, konisch, 17 cm
Aufricht nasal fracture elevator, straight, conical, 17 cm

20-850-17

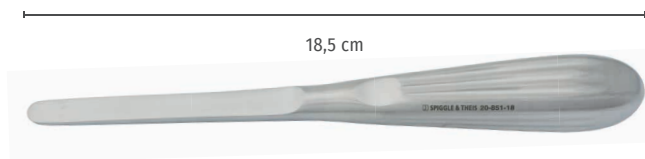

Boies Elevatorium, gerade, oval, fein, 18,5 cm
Boies elevator, straight, oval, fine, 18.5 cm

20-851-18

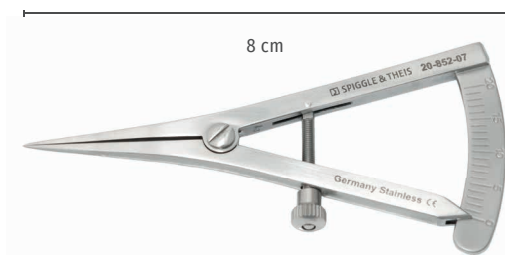

Castroviejo Nasenzirkel, 8 cm
Castroviejo nasal caliper, 8 cm

20-852-07

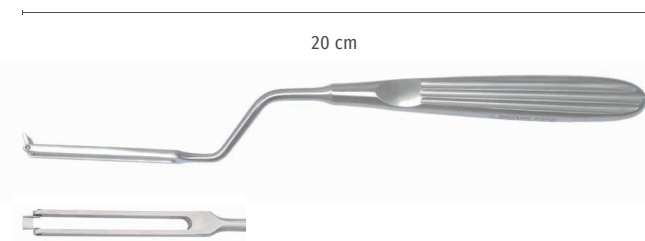

Ballenger Schwingmesser, bajonett, 20 cm
Ballenger swivel knife, bayonet, 20 cm

Art.-Nr./No.	Größe / Size (mm)
20-853-03	3
20-853-04	4



12 Allgemeines

Miscellaneous

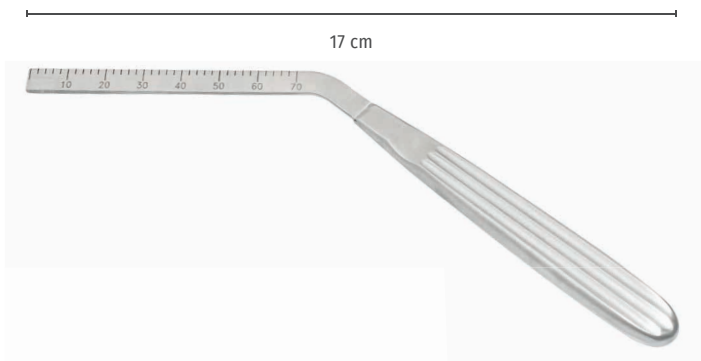

Joseph Anlegeinstrument zur Rhinoplastik, gewinkelt, 17 cm
Joseph placing instrument for rhinoplasty, angled, 17 cm

20-856-17

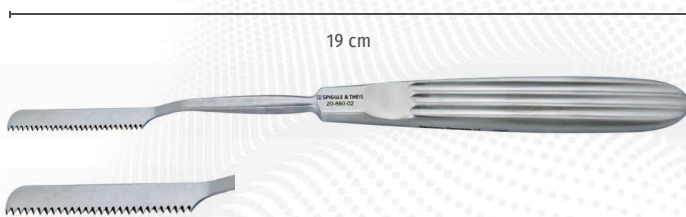

Joseph Nasensäge, 19 cm / Joseph nasal saw, 19 cm

Art.-Nr./No.	Beschreibung / Description
20-860-01	gerade / straight
20-860-02	bajonett, rechts bayonet, right
20-860-03	bajonett, links bayonet, left



**Cottle Knochen- und Knorpelquetscher,
mit Entnahmefeder, zerlegbar**

Cottle bone and cartilage crusher, with clamp, dismantable

Art.-Nr./No.	Breite / Width (cm)
20-865-30	2,4
20-865-50	6,0

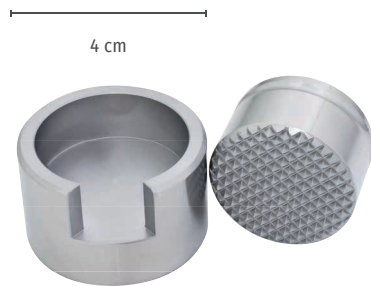

Tolsdorff Knochen- und Knorpelquetscher, rund, 4 cm, Parallelhub
Tolsdorff bone and cartilage crusher, round, 4 cm, parallel lift

Art.-Nr./No.	Beschreibung / Description
20-867-40	geriefte Schlagfläche / serrated surface
20-868-40	glatte Schlagfläche / even surface



Non-Stick bipolare Pinzette, 1 mm, 16 cm
Non-Stick bipolar forceps, 1 mm, 16 cm

Art.-Nr./No.	Beschreibung / Description
80-101-16	gerade / straight
80-106-16	abgewinkelt / angled
80-111-16	bajonett / bayonet



Spezial Ölspray, Pflegespray für Instrumente und Bohrhandstücke, 500 ml
Special Oilspray, Maintenance Spray for Instruments and Drill Handpieces, 500 ml

00-108-005

12 Allgemeines - Bipolare Anschlusskabel

Miscellaneous - Bipolar Connecting Cable



Geräteseitig, 22 mm, passend für / unit-side, 22 mm, compatible to Erbe / EMC / Dolly

Art.-Nr./No.	Länge / Length (m)
80-316-50	5



Geräteseitig, passend für / unit-side, compatible to Sutter/Martin/Berchtold/Aesculap/Integra/SPIGGLE & THEIS

Art.-Nr./No.	Länge / Length (m)
80-317-30	3
80-317-50	5



Geräteseitig, passend für / unit-side, compatible to Erbe/Storz/Wolf

Art.-Nr./No.	Länge / Length (m)
80-318-30	3
80-318-50	5



Geräteseitig, 29 mm, passend für / unit-side, 29 mm, compatible to Valleylab/Lamidey/EMC/Bowa/Olympus

Art.-Nr./No.	Länge / Length (m)
80-319-30	3
80-319-50	5



Für bipolare Scheren/Zangen, geräteseitig, passend für / for bipolar scissors/forceps, unit-side, compatible to Sutter/Martin/Berchtold/Aesculap/Integra

Art.-Nr./No.	Länge / Length (m)
80-320-30	3
80-320-50	5



Für bipolare Scheren, passend für / for bipolar scissors, compatible with Erbe/Storz/Wolf

Art.-Nr./No.	Länge / Length (m)
80-322-30	3,0
80-322-50	5,0

**Metallschale / Metal bowl**

Art.-Nr. Art.-No.		Durchmesser Diameter (mm)	Höhe Height (mm)	Fassungs- vermögen Capacity (ml)
80-501-01	B1	Ø 40	H=19	20
80-501-02	B2	Ø 60	H=39	60
80-501-03	B3	Ø 85	H=40	160
80-501-04	B4	Ø 110	H=55	400

**Metallbecher, mit Griff****Metal cup, with handle**

Art.-Nr. Art.-No.		Durchmesser Diameter (mm)	Höhe Height (mm)	Fassungs- vermögen Capacity (ml)
80-500-00		Ø 69	H=95	350

**Medizinbecher, Edelstahl, graduert****Medicine cup, stainless steel, graduated**

Art.-Nr. Art.-No.		Durchmesser Diameter (mm)	Höhe Height (mm)	Fassungs- vermögen Capacity (ml)
80-503-03		Ø 50	H=25	30
80-504-05		Ø 53	H=45	50

**Lösungsschale, Edelstahl****Solution bowl, stainless steel**

Art.-Nr. Art.-No.		Durchmesser Diameter (mm)	Höhe Height (mm)	Fassungs- vermögen Capacity (ml)
80-505-10		Ø 72	H=33	100
80-505-20		Ø 87	H=50	200
80-506-30	B1	Ø 95	H=60	300
80-507-40	B2	Ø 120	H=70	500
80-509-75	B3	Ø 150	H=75	750

**Tablettenschale, Edelstahl, Ø 65 mm, H=20 mm****Tablet dish, stainless steel, Ø 65 mm, H=20 mm****80-512-00****Petrishale, Klarglas, mit Deckel / Petri dish, clear glass, with lid**

Art.-Nr./No.	AD / OD (mm)	Höhe / Height (mm)
80-515-06	60	15
80-515-08	80	15
80-515-10	150	20



12 Allgemeines

Miscellaneous



80-519-00



80-519-01



80-519-02



80-519-03

Medikamenten-Schälchen, Dappenglas, farbig, Ø 3,2 cm Medication dish, dappen-glass, colored, Ø 3.2 cm

Art.-Nr./No.	Farbe / Color
80-519-00	kristall / crystal
80-519-01	grün / green
80-519-02	rosa / pink
80-519-03	topas / topaz



Porzellan-Schälchen, rund, mit Ausguss China bowl, round, with spout

Art.-Nr./No.	Durchmesser / Diameter (cm)
80-520-06	Ø 8
80-520-08	Ø 10



Nierenschale, Edelstahl / Kidney bowl, stainless steel

Art.-Nr./No.	Größe / Size (cm)
80-525-17	17,5
80-525-25	25,0



Kornzangen-Behälter, Edelstahl Forceps holder, stainless steell

Art.-Nr. Art.-No.	Durchmesser Diameter (cm)	Höhe Height (cm)
80-528-13	Ø 5,0	13,5
80-528-18	Ø 5,0	18,0
80-528-20	Ø 9,5	20,0



Kornzangen-Behälter, Glas, Edelstahldeckel mit Ausschnitt, Ø 8 cm, Höhe 20 cm Forceps holder, glass, stainless steel lid with opening, Ø 8 cm, height 20 cm

80-530-20





















Norm-Sterilisations-Container, geschlossener Boden
Norm sterilization container, bottom closed

Art.-Nr. Art.-No.	Größe Size	Maße (ausßen) Dimension (outside) (mm)
80-631-10	1/2	297 x 274 x 88
80-631-12	1/2	297 x 274 x 123
80-631-14	1/2	297 x 274 x 138
80-631-21	1/2	297 x 274 x 188
80-641-14	3/4	462 x 274 x 138
80-661-12	1	585 x 274 x 123
80-661-14	1	585 x 274 x 138
80-661-21	1	585 x 274 x 188



Ventil-Deckel für Norm-Sterilisations-Container
Valve lid for norm sterilization container

Art.-Nr./No. 1/2 299 x 278 mm	Art.-Nr./No. 3/4 462 x 278 mm	Art.-Nr./No. 1 585 x 278 mm
80-632-00 	80-642-00 	80-662-00 
80-632-01 	80-642-01 	80-662-01 
80-632-02 	80-642-02 	80-662-02 
80-632-03 	80-642-03 	80-662-03 
80-632-04 	80-642-04 	80-662-04 
80-632-05 	80-642-05 	80-662-05 



Siebkorb, Edelstahl-Drahtgeflecht, Fallgriffe
Stainless-steel wire basket, sliding handles

Art.-Nr./No.	Größe / Size (mm)
80-671-20	255 x 245 x 50
80-671-25	255 x 245 x 70
80-671-40	405 x 255 x 70
80-671-60	485 x 255 x 70



Cudier-Schild, 56 x 17 cm, 20 Zeichen
Coding label, 56 x 17 mm, 20 letters

Art.-Nr./No.	Farbe / Colour
80-681-01	schwarz / black
80-681-02	rot / red
80-681-03	braun / brown
80-681-04	grün / green
80-681-05	gelb / yellow
80-681-06	lila / purple
80-681-07	blau / blue



13 Zubehör - Sterilisationssysteme

Accessories - Sterilization Systems

Einweg-Container-Siegel, blau, 100 Stück/Box
Container seal, disposable, blue, 100 pieces/box

80-683-10

Silikonmatte, blau, perforiert, 440 x 230 mm
Silicon mat, blue, perforated, 440 x 230 mm

80-675-00

Indikator-Klebe-Etikett, Lasche rechts, 100 Stück/Box
Adhesive indicator label, latch right side, 100 pieces/box

80-684-10

Klemmschild aus Edelstahl, hitzebeständig,
6 x 4 cm, 25 Stück/Box
Label holder with clip, stainless steel, heat resistant,
6 x 4 cm, 25 pieces/box

80-688-00



Endoskopie-Siebkorb mit Deckel, Edelstahl, elektropliert
Endoscope container with lid, stainless steel, e-polished

Art.-Nr./No.	Größe / Size (cm)
80-690-01	29 x 8 x 5,2 für 1 Endoskop 29 x 8 x 5,2 for 1 endoscope
80-690-02	29 x 8 x 5,2 für 2 Endoskope 29 x 8 x 5,2 for 2 endoscopes



Endoskopie-Siebkorb mit Deckel, Edelstahl, elektropliert
Endoscope container with lid, stainless steel, e-polished

Art.-Nr./No.	Größe / Size (cm)
80-691-01	46 x 8 x 5,2 für 1 Endoskop 46 x 8 x 5,2 for 1 endoscope
80-692-01	67 x 8 x 5,2 für 1 Endoskop 67 x 8 x 5,2 for 1 endoscope

Bestehend aus / Consisting of:

- 20-425-02 Osteotom Premium Line, 2 mm, 18 cm, vergoldeter Griff
Osteotome Premium Line, 2 mm, 18 cm, golden handle
- 20-425-03 Osteotom Premium Line, 3 mm, 18 cm, vergoldeter Griff
Osteotome Premium Line, 3 mm, 18 cm, golden handle
- 20-425-06 Osteotom Premium Line, 6 mm, 18 cm, vergoldeter Griff
Osteotome Premium Line, 6 mm, 18 cm, golden handle
- 20-425-10 Osteotom Premium Line, 10 mm, 18 cm, vergoldeter Griff
Osteotome Premium Line, 10 mm, 18 cm, golden handle
- 20-425-12 Osteotom Premium Line, 12 mm, 18 cm, vergoldeter Griff
Osteotome Premium Line, 12 mm, 18 cm, golden handle
- 20-425-14 Osteotom Premium Line, 14 mm, 18 cm, vergoldeter Griff
Osteotome Premium Line, 14 mm, 18 cm, golden handle
- 20-425-25 Osteotom Premium Line, 2,5 mm, 18 cm, vergoldeter Griff
Osteotome Premium Line, 2.5 mm, 18 cm, golden handle
- 20-426-00 Osteotom Premium Line, mit Schutzsonde, 2,2 mm, 18 cm, vergoldeter Griff
Osteotome, Premium Line, guarded, 2.2 mm, 18 cm, golden handle
- 20-579-04 Cottle Doppel-Haken, beidseitig scharf, extra fein, 10 mm, 12 cm, vergoldeter Griff
Cottle double hook, both prongs sharp, very fine, 10 mm, 12 cm, golden handle
- 20-588-01 Wundhäkchen, superfein, 1-zinkig, 15,5 cm, vergoldeter Griff
Skin hook, very fine, 1 prong, 15.5 cm, golden handle
- 20-588-02 Wundhäkchen, superfein, 2-zinkig, 16 cm, vergoldeter Griff
Skin hook, very fine, 2 prongs, 16 cm, golden handle
- 20-568-16 Nasenrückenhaken, extra fein, 45 mm, 15,5 cm, vergoldeter Griff
Aufricht nasal retractor, extra fine, 45 mm, 15.5 cm, golden handle
- 10-532-12 Schere, Hartmetall, spitz-spitz, gerade, 11,5 cm, vergoldeter Griff
Scissors, tungsten carbide, straight, pointed, 11.5 cm, golden handle
- 10-535-12 Schere, Hartmetall, sp-sp, gebogen, 11,5 cm, vergoldeter Griff
Scissors, TC, curved, pointed, 11.5 cm, golden handle
- 20-631-10 Walter Schere, gewinkelt, 10 cm, vergoldeter Griff
Walter scissors, angled, 10 cm, golden handle
- 20-713-12 Adson-Brown-Pinzette, Hartmetall, 7:8 Zähne, 12 cm, vergoldeter Griff
Adson-Brown dressing forceps, TC, 7:8 teeth, 12 cm, golden handle
- 10-496-12 Adson-Pinzette, Hartmetall, anatomisch, 12 cm, vergoldeter Griff
Adson dressing forceps, TC, anatomical, 12 cm, golden handle
- 20-714-12 Adson-Pinzette, Hartmetall, 1:2 Zähne, 12 cm, vergoldeter Griff
Adson dressing forceps, TC, 1:2 teeth, 12 cm, golden handle
- 20-215-01 Blakesley Nasenzange, gerade, 3,5 mm, 11,5 cm, vergoldeter Griff
Blakesley nasal forceps, 3.5 mm, 11.5 cm, straight, golden handle
- 20-622-13 Kilner Rhinoplastik Schere, Hartmetall, flache Spitze, stumpf, gebogen, 12,5 cm, vergoldeter Griff
Kilner rhinoplasty scissors, TC, flat end, blunt, curved, 12.5 cm, golden handle
- 10-555-13 Nadelhalter, Hartmetall, fein, 13 cm, vergoldeter Griff
Halsey needle holder, TC, delicate, 13 cm, golden handle
- 20-825-18 Aufricht Glabella Rassel, einseitig, auf Zug und Druck, 19 cm, vergoldeter Griff
Aufricht Glabella rasp, single ended, up and down cutting, 19 cm, golden handle
- 10-353-13 Raspatorium, gerade, 4 mm, 18 cm, vergoldeter Griff
Raspatory, straight, 4 mm, 18 cm, golden handle
- 20-801-03 Fomon Nasenraspel, Hartmetall, doppelseitig, Körnung 5/6 (mittel), 20,5 cm, vergoldeter Griff
Fomon nasal rasp, TC, double ended, grain size 5/6 (medium), 20.5 cm, golden handle
- 20-801-04 Fomon Nasenraspel, Hartm., doppelseitig, Körnung 7/8 (mittel/fein), 20,5 cm, vergoldeter Griff
Fomon nasal rasp, TC, double ended, grain size 7/8 (medium/fine), 20.5 cm, golden handle

Ergänzung**Supplement**

- 80-631-14 Norm-Sterilisations-Container Boden geschlossen, 297x274x138 mm Maße mit Deckel: 585x278x155 mm
Norm sterilization container, bottom closed, 297x274x138 mm, dimensions with fitted lid: 299x278x155mm
- 80-632-00 Ventildeckel silber, für Container 80-631-14, 299x278 mm
Valve lid, silver, for container 80-631-xx, 299x278 mm
- 80-671-20 1x Edelstahl-Siebkorb, Geflecht, Fallgriffe, 255 x 245 x 50 mm
1x Stainless steel wire basket, sliding handles, 255 x 245 x 50 mm
- 80-681-02 1x Aluminium-Kennzeichnungs-Schild, rot, 20 Zeichen, 56 x 17 mm
1x Aluminium tag, red, 20 letter, 56 x 17 mm

[Supplement for sales in EU \(outside the EU only on request\)](#)



14 Rhinoplastik-Set

Rhinoplasty set

Bestehend aus / Consisting of:

- 10-360-03 Skalpell-Griff / Scalpel handle
20-500-13 Cottle Septum-Messer / Cottle septum knife
20-501-14 Masing Ritzmesser / Masing pointed knife
20-800-16 Watteträger / Cotton carrier
20-601-14 Joseph Schere / Joseph scissors
20-610-15 Reynolds Schere / Reynolds scissors
20-615-15 Metzenbaum Schere / Metzenbaum scissors
20-627-13 Goldman Fox Schere / Goldman Fox scissors
20-630-10 Walter Schere / Walter scissors
20-632-12 Cottle Nasenflügelschere / Cottle lower lateral scissors
20-560-15 Cottle Nasenflügelhaken / Cottle alar retractor
20-570-13 Aufricht Doppelhaken / Aufricht double retractor
20-574-06 Cottle Fingerring-Häkchen / Cottle thimble hook
20-577-16 Cottle Hauthäkchen / Cottle skin hook
20-579-01 Cottle Doppel-Haken rechts geknöpft
Cottle double hook, right prong blunt
20-579-02 Cottle Doppel-Haken links geknöpft
Cottle double hook, left prong blunt
20-700-10 Cottle Columella-Klemme / Cottle columella forceps
20-710-12 Adson-Brown Pinzette / Adson-Brown forceps
20-705-14 Herberhold Hautfazzange / Herberhold tissue forceps
20-720-14 Cottle Nasenpinzette / Cottle lower lateral forceps
20-730-16 Jansen Nasenpinzette / Jansen nasal forceps
20-199-05 Saugrohr mit abgeflachtem Ende / Suction tube with flattened end
10-302-35 2x Saugrohr, kniegebogen, konisch / 2x Suction tube, angled, conical
10-300-25 2x Saugrohr, kniegebogen, zylindrisch / 2x Suction tube, angled, cylindrical
20-322-01 Guillen Saugraspatorium / Guillen suction raspatory
20-300-21 Masing Elevatorium/Raspatorium / Masing elevator/raspatory
20-305-18 Freer Doppelelevatorium / Freer elevator, double ended
20-318-04 McKenty Raspatorium, stark gebogen
McKenty raspatory, strongly curved
20-312-23 Cottle Tunnel-Raspatorium, doppelseitig
Cottle tunneling raspatory, double ended
20-100-01 Hartmann Nasentamponadezange
Hartmann nasal dressing forceps
20-152-55 Herberhold Septum-Spekulum, 55 mm
Herberhold septum speculum, 55 mm
20-152-75 Herberhold Septum-Spekulum, 75 mm
Herberhold septum speculum, 75 mm
20-152-90 Herberhold Septum-Spekulum, 90 mm
Herberhold septum speculum, 90 mm
20-215-00 Blakesley Nasenzange Premium, gerade, 3,0 mm
Blakesley Premium nasal forceps, straight, 3.0 mm
20-215-02 Blakesley Nasenzange Premium, gerade, 4,0 mm
Blakesley Premium nasal forceps, straight, 4.0 mm
20-225-01 Blakesley Nasenzange Premium, 45°, aufgebogen
Blakesley Premium nasal forceps, 45° upcurved
20-270-19 Kazanjian Knochenzange / Kazanjian rongeur
20-287-23 Cottle-Walsham Septum-Richtzange
Cottle-Walsham septum straightening forceps
20-400-18 Cottle Hammer / Cottle mallet
20-865-30 Cottle Knochen- und Knorpelquetscher
Cottle bone- and cartilage crusher
20-425-02 Osteotom Premium Line, 2 mm / Osteotome Premium Line, 2 mm
20-425-03 Osteotom Premium Line, 3 mm / Osteotome Premium Line, 3 mm
20-425-06 Osteotom Premium Line, 6 mm / Osteotome Premium Line, 6 mm
20-425-12 Osteotom Premium Line, 12 mm / Osteotome Premium Line, 12 mm
20-435-02 Herberhold Osteotom zur lateralen Osteotomie, links
Herberhold osteotome for lateral osteotomy, left
20-435-03 Herberhold Osteotom zur lateralen Osteotomie, rechts
Herberhold osteotome for lateral osteotomy, right
20-801-02 Fomon Nasenraspel Größe 3/4 / Fomon nasal rasp, size 3/4
20-801-05 Fomon Nasenraspel Größe 9/10 / Fomon nasal rasp, size 9/10
20-810-21 Fomon Nasenraspel, Diamant, goldener Griff
Fomon nasal rasp, diamond, golden handle
20-808-00 Aufricht Glabella Raspel, Hartmetall
Aufricht glabella rasp, tungsten carbide
20-740-15 Crile-Wood Nadelhalter / Crile-Wood needleholder
20-744-17 Senning Nadelhalter, extra schlank
Senning needle holder, slender shape
20-856-17 Joseph Anlegeinstrument zur Rhinoplastik, gewinkelt
Joseph placing instrument for rhinoplasty, angled
20-852-07 Castroviejo Nasenzirkel, 20 mm-Skala
Castroviejo nasal caliper, 20 mm scale
80-100-16 Non-Stick Bipolare Pinzette / Bipolar forceps
80-318-50 Bipolares Anschlusskabel passend für Erbe/Storz/Wolf 5 m
Bipolar connecting cable compatible with Erbe/Storz/Wolf 5 m
80-503-03 Medizinbecher, graduiert, 30 ml / Medical cup, graduated, 30 ml
80-504-05 Medizinbecher, graduiert, 50 ml / Medical cup, graduated, 50 ml

Ergänzung

Supplement

- 10-360-11 Skalpell-Klingen Nr. 11 / Scalpel blades No. 11
10-360-15 Skalpell-Klingen Nr. 15 / Scalpel blades No. 15
20-551-64 Mikro-Klingen SM64 / Micro blades SM64
20-551-65 Mikro-Klingen SM65 / Micro blades SM65
80-661-14 Norm-Sterilisations-Container Boden geschlossen, 585x274x138 mm
Maße mit Deckel: 585x278x155 mm / Norm sterilization container
bottom closed, 585x274x138 mm, dimensions with fitted
lid: 585x278x155mm
80-662-00 Ventildeckel silber, für Container 80-661-14 585x278 mm
Valve lid silver, for container 80-661-xx, 585x278 mm
80-671-60 Edelstahl-Siebkorb Geflecht, Fallgriffe 485x255x70 mm
Stainless steel wire basket, sliding handles 485x255x70 mm
80-681-04 Aluminium-Kennzeichnungs-Schild grün, 20 Zeichen 56x17 mm
Aluminium tag green, 20 letters, 56x17 mm

Supplement for sales in EU (outside the EU only on request)

Bestehend aus / Consisting of:

20-100-01	Hartmann Nasenspekulum Hartmann nasal speculum	20-730-16	Jansen Nasenpinzette Jansen nasal forceps
20-152-55	Herberhold Septum-Spekulum, extra fein, 55 mm Herberhold septum speculum, extra fine, 55 mm	10-480-14	Pinzette, anatomisch, gerade Dressing forceps, anatomical, straight
20-152-75	Herberhold Septum-Spekulum, extra fein, 75 mm Herberhold septum speculum, extra fine, 75 mm	10-483-14	Pinzette, chirurgisch, 1:2 Zähne Dressing forceps, 1:2 teeth, straight
20-190-25	Krause Nasen-Polypen-Schnürer, scharf Krause nasal polyp snare, sharp	20-740-15	Crile-Wood Nadelhalter Crile-Wood needleholder
20-195-35	Nasenpolypenschlingen, 0,35 mm, 100 Stück Nasal snare wires, 0.35 mm, 100 pieces	20-800-16	Watteträger, Ø 1,2 mm, 5 Stück Cotton carrier, Ø 1.2 mm, 5 pieces
20-200-20	Hartmann Nasentamponadezange 20 cm Hartmann nasal dressing forceps 20 cm	20-850-17	Aufricht Nasenfraktur-Elevatorium Aufricht nasal fracture elevator,
20-215-01	Blakesley Nasenzange Premium, 3,5 mm, gerade Blakesley premium nasal forceps, 3.5 mm, straight	10-302-30	Saugrohr, kniegebogen, konisch Suction tube, angled, conical
20-215-03	Blakesley Nasenzange Premium, 5 mm, gerade Blakesley premium nasal forceps, 5 mm, straight	10-300-40	Saugrohr, kniegebogen, zylindrisch Suction tube, angled, cylindrical
20-225-02	Blakesley Nasenzange Premium, 45° aufgebogen Blakesley premium nasal forceps, 45° upcurved	10-550-13	Universalschere, gebogen, spitz-stumpf Universal scissors, curved, sharp-blunt
20-259-00	Craig-Domnick Septum-Zange, scharf Craig-Domnick septum forceps, sharp	30-082-12	Frazier Saugrohr, kniebogen Frazier suction tube, angled
20-300-21	Masing Elevatorium/Raspatorium Masing elevator/raspatory	80-111-16	Non-Stick Bipolare Pinzette Bipolar forceps
20-305-18	Freer Doppelevatorium, scharf/stumpf Freer elevator, double ended, sharp/blunt	80-318-50	Bipolares Anschlusskabel passend für Erbe/Storz/Wolf 5 m Bipolar connecting cable compatible with Erbe/Storz/Wolf 5 m
20-322-01	Guillen Saugraspatorium Guillen suction raspatory	80-503-03	Medizinbecher, graduiert, 30 ml, 2x Medical cup, graduated, 30 ml, 2x
20-318-05	McKenty Raspatorium, stark gebogen McKenty raspatory, strongly curved	80-504-05	Medizinbecher, graduiert, 50 ml, 2x Medical cup, graduated, 50 ml, 2x
20-312-23	Cottle Tunnel-Raspatorium, doppelseitig Cottle tunneling raspatory, double ended		
20-400-18	Cottle Hammer Cottle mallet		
20-405-04	Cottle Meißel, 4 mm Cottle chisel, 4 mm		
20-405-07	Cottle Meißel, 7 mm Cottle chisel, 7 mm		
20-409-06	Cottle Meißel, flach, gebogen, 6 mm Cottle chisel, flat, curved, 6 mm		
20-500-13	Cottle Septum-Messer Cottle septum knife		
20-501-14	Masing Ritzmesser Masing pointed knife		
20-560-15	Cottle Nasenflügelhaken Cottle alar retractor		
20-601-14	Joseph Schere Joseph scissors		
20-615-15	Metzenbaum Schere Metzenbaum scissors		
20-630-10	Walter Schere Walter scissors		
20-680-16	Heymann Nasenschere, gezahnt Heymann nasal scissors, toothed		
20-700-10	Cottle Columella-Klemme, 11 cm, 2x Cottle columella forceps, 11 cm		
20-710-12	Adson-Brown Pinzette, 2x Adson-Brown forceps, 2x		
20-720-14	Cottle Nasenpinzette 2x Cottle lower lateral forceps, 2x		
		80-661-14	Norm-Sterilisations-Container Boden geschlossen, 585x274x138 mm Maße mit Deckel: 585x278x155 mm / Norm sterilization container bottom closed, 585x274x138 mm, dimensions with fitted lid: 585x278x155mm
		80-662-00	Ventildeckel silber, für Container 80-661-xx, 585x278 mm Valve lid silver, for container 80-661-xx, 585x278 mm
		80-671-60	Edelstahl-Siebkorb Geflecht, Fallgriffe 485x255x70 mm Stainless steel wire basket, sliding handles 485x255x70 mm
		80-681-03	Aluminium-Kennzeichnungs-Schild braun, 20 Zeichen 56x17 mm Aluminium tag brown, 20 letters, 56x17 mm

Ergänzung**Supplement**

Supplement for sales in EU (outside the EU only on request)



Alphabetisches Inhaltsverzeichnis

Adson Pinzetten	58 - 59	Freer Wundhäkchen	44	Neivert Nadelhalter.....	61
Adson-Brown Pinzette.....	58 - 59	Gelenkkloben	13	Nierenschale, Edelstahl.....	72
Anderson Nasenraspel.....	66	Gillies Gewebepinzette.....	60	Norm-Sterilisations-Container.....	73
Anderson-Neivert Osteotom.....	39	Gillies Hauthäkchen	45	Noyes Nasentamponadezange.....	15
Antibeschlagmittel	7	Glatzel Nasenspiegel.....	16	Ölspray.....	69
Ash Septum-Richtzange.....	27	Goldman-Fox Schere.....	52	Osteotome	34 - 39
Aufricht Doppelhaken.....	43	Graefe Pinzetten.....	60	Osteotom Premium Line	37
Aufricht Glabella Raspel.....	64, 66	Guillen Saugraspatorium.....	32	Parkes Nasenraspel.....	64
Aufricht Haken für flexiblen Spannarm.....	13	Hajek Metallhammer.....	33	Petrischale	71
Aufricht Nasenfraktur-Elevatorium.....	67	Halsey Nadelhalter	61	Pinzette, anatomisch	60
Aufricht Nasenrückenhaken	43	Hämmer	33	Pinzette, chirurgisch.....	60
Ballenger-Messer.....	67	Handgriff mit Raspelplatten	63	Porzellan-Schälchen.....	72
Becker Nasenschere.....	28	Hartmann Conchotom	24	Premium Rhinoplastik-Set.....	75
Beckmann Naspekulum	11	Hartmann Nasenspekulum	10	Premium Scheren.....	46 - 47
Bipolare Pinzette, Non-Stick.....	69	Hartmann-Halle Nasenspekulum.....	10	Raspatorium, gerade.....	31
Bipolares Anschlusskabel.....	70	Hartmann Nasentamponadezange.....	15	Raspeleinsätze.....	63
Blakesley Nasenzangen.....	19 - 22	Herberhold Hautfasszange.....	58	Reynolds Scheren	46, 49
Blakesley Nasenzangen Komfort Serie.....	19	Herberhold Osteotom.....	39	Rhinoplastik-Set.....	76
Boies Elevatorium	67	Herberhold Septum-Spekulum.....	12	Rowland Nasenzange.....	23
Caplan Nasenschere.....	24	Heymann Nasenschere.....	47, 56 - 57	Rubin Knorpelquetschzange.....	27
Castroviejo Mikro-Gefäß-Nadelhalter.....	62	Hohenhorst Conchotomie Schere	26	Rubin Osteotome	35
Castroviejo Nasenzirkel.....	67	Jansen-Middleton Septumzange	28	Saugrohre.....	17 - 18
Cinelli Osteotom.....	36	Jansen Nasenpinzette	17	Schere, Hartmetall.....	47, 52 - 53
Conchotomie Schere, gezahnt.....	57	Joseph Doppel-Häkchen	45	Schere, spitz-spitz.....	52 - 53
Codier-Schild.....	73	Joseph Anlegeinstrument	68	Schere, stumpf-stumpf.....	53 - 54
Converse Nadelhalter	62	Joseph Nasenraspel	66	Schere, supercut.....	52 - 53
Converse Nasenflügel-Doppelhaken.....	42	Joseph Nasensäge.....	68	Schmeden Conchotom	24
Cottle Columella-Klemme.....	58	Joseph Rhinoplastikmesser	41	Schuknecht Drahtschneidescherchen	54
Cottle Doppel-Haken	44	Joseph Schere	47 - 48	Schutzhülse für Rubin Knorpelquetschzange.....	27
Cottle Elevatorium / Raspatorium	29	Joseph Wundhaken.....	45	Selbsthaltendes Spekulum	13
Cottle Fingerring-Häkchen	43	Kabierske Kanüle	16	Senning Nadelhalter	61
Cottle Hammer.....	33	Kabierske Pulverbläser	16	Septum-Set.....	77
Cottle Hauthäkchen.....	44 - 45	Kazanjan Kochenzange.....	23	Siebkorb	73
Cottle Knochen- und Knorpelquetscher	68	Killian Septum-Spekulum	11 - 12	Sinuskope.....	5 - 6
Cottle Meißel.....	34 - 35	Killian Raspatorium, doppelseitig.....	29	Skalpell-Griff.....	40
Cottle Nasenflügelhaken.....	42	Killian-Claus Hohlmeißel.....	38	Skalpell-Klingen.....	40
Cottle Nasenflügelschere.....	55	Killian-Struycken Septum-Spekulum	11	Stevens Gefäßscheren.....	51
Cottle Nasenhaken	42	Kilner Rhinoplastikscheren.....	50 - 51	Strümpel-Voss Nasenzange	21
Cottle Nasenpinzette	60	Kilner Wundhäkchen.....	43	Struycken Nasenzange	24
Cottle Nasenraspel	65	Kleinert-Kutz Nasenraspel	66	Tablettenschale.....	71
Cottle Nasenschere	56	Kornzangen-Behälter.....	72	Takahashi Nasenzange	21 - 22
Cottle-Neivert Doppelhaken.....	42	Krause Nasen-Polypen-Schnürer	14	Tieck-Halle Nasenspekulum	10
Cottle Osteotom	34- 35 38	Krause-Voss Nasen-Polypen-Schnürer.....	14	Tolsdorff Knochen- u. Knorpelquetscher.....	69
Cottle Osteotom, flach.....	34	Kressner Muschelquetschzange	26	Ultra-Stop Antibeschlagmittel.....	7
Cottle Osteotom mit Führungsdorn.....	38	Lange Nasen-Polypen-Schnürer	14	Ulmer Raspatorium	31
Cottle Osteotom, 2 Führungsdorne.....	35	LED-Leuchtgriffe.....	8	Universalschere, gebogen	54
Cottle Raspatorium.....	30	Lempert Raspatorium	30 - 31	Walter Hohlmeißel.....	38
Cottle Septum-Messer.....	40	Lösungsschale	71	Walter Osteotom	36
Cottle Septum-Spekula	11 - 13	Maltz Nasenraspel	64 - 65	Walter Schere	55
Cottle Tunnel-Raspatorium.....	30	Masing Elevatorium/Raspatorium	29	Watson-Wiliams Nasenzange	22
Cottle-Walsham Septum-Richtzange.....	27	Masing Nadelhalter	62	Watteträger	17
Craig Septum-Zange.....	23	Masing Nasenraspel	65	Weber Doppellevatorium	29
Craig-Domnick Septum-Zange.....	23	Masing Osteotome.....	38 - 39	Weber Nasenschere	57
Crile-Wood Nadelhalter	61	Masing Ritzmesser.....	40	Westmacott Nasentamponadezange.....	15
Crile-Wood Ryder Nadelhalter	61	McKenty Doppelraspatorien	29	Wigand Polypen-Fasszange.....	25
DeBaKey Pinzette	59	McKenty Raspatorien.....	31	Wundhäkchen, superfein	45
Dichtigkeitstester.....	7	Medikamenten-Schälchen, Dappenglas	72	Wullstein Raspatorium	31
Durchschneidende Nasenzange	25	Medizinbecher	71	Wurm Osteotom	39
Endoskopie-Siebkorb.....	74	Metallbecher mit Griff	71	Yankauer Septumnadel.....	45
Ferris-Smith Nasenzange	22	Metallschale	71	Ziehstange für Nasen-Polypen-Schnürer.....	14
Flexibler Spannarm	13	Metzenbaum Scheren	46, 48 - 50	Zubehör.....	71 - 74
Flexibles Endoskop.....	9	Mikro-Adson-Pinzette.....	59		
Fomon Nasenflügelhaken	44	Mikro-Gefäßschere	57		
Fomon Nasenraspel.....	63	Mikro Handgriff.....	41		
Fomon Nasenraspel, Diamant.....	65	Mikro-Klingen.....	41		
Fomon Nasenscheren	55 - 56	Mikro-Ryder Nadelhalter	62		
Frazier Saugrohr	18	Miller Nasenraspel.....	64		
Freer Doppellevatorium.....	29	Nasensonde.....	30		
Freer Golfstock-Raspatorium.....	29	Nasenspekulum Modell Wien.....	10		
Freer-Joseph Doppel-Raspatorium	30	Nasenpolypenschlingen.....	14		
Freer Septum Messer.....	40	Neivert Draht-Doppelhaken.....	42		

Accessories	71 - 74	Freer elevator, double ended	29	Nasal conchotomy scissors, serrated	57
Adson forceps	58 - 59	Freer hook	44	Nasal probe	30
Adson-Brown forceps	58 - 59	Freer golf club raspatory	29	Nasal speculum type Vienna	10
Anderson nasal rasp	66	Freer-Joseph raspatory, double ended	30	Nasal polyp snares	14
Anderson-Neivert osteotome	39	Freer septum knife	40	Neivert needle holder	61
Anti-Fog	7	Gillies skin hook	45	Neivert wire-shaped retractor	42
Ash septum straightening forceps	27	Gillies tissue forceps	60	Norm sterilization container	73
Aufricht double hook	43	Glatzel nasal mirror	16	Noyes nasal sponge holding forceps	15
Aufricht glabella rasp	64, 66	Goldman-Fox scissors	52	Oil spray	69
Aufricht hook for flexible holding arm	13	Graefe tissue forceps	60	Osteotomes	34 - 39
Aufricht nasal fracture elevator	67	Guillen suction raspatory	32	Osteotome Premium Line	37
Aufricht nasal retractors	43	Hajek metal mallet	33	Parkes nasal rasp	64
Basket	73	Halsey needle holder	61	Petri dish	71
Ballenger knife	67	Handle for rasps	63	Premium Rhinoplasty Set	75
Becker nasal scissors	28	Hartmann cutting forceps	24	Premium Scissors	46 - 47
Beckmann nasal speculum	11	Hartmann nasal dressing forceps	15	Raspatory, straight	31
Bipolar connection cable	70	Hartmann nasal speculum	10	Reynolds scissors	46, 49
Bipolar forceps, Non-Stick	69	Hartmann-Halle nasal speculum	10	Rhinoplasty set	76
Blakesley nasal forceps	19 - 22	Herberhold osteotome	39	Rotation clamp	13
Blakesley nasal forceps Comfort Series	19	Herberhold septum speculum	12	Rowland rongeur	23
Boies Elevator	67	Herberhold tissue forceps	58	Rubin morcelizer forceps	27
Caplan nasal scissors	24	Heymann nasal scissors	47, 56 - 57	Rubin osteotome	35
Castroviejo micro vascular needle holder	62	Hohenhorst conchotomy scissors	26	Scalpel blades	40
Castroviejo nasal caliper	67	Insert for rasp	63	Scalpel handle	40
China bowl	72	Jansen-Middleton septum forceps	28	Schmeden cutting forceps	24
Cinelli osteotome	36	Jansen nasal forceps	17	Schuknecht wire cutting scissors	54
Coding label	73	Joseph double hook	45	Scissors, blunt	53 - 54
Converse alar double hook	42	Joseph placing instrument	68	Scissors, pointed	47, 52 - 53
Converse needle holder	62	Joseph nasal rasp	66	Scissors, supercut	52 - 53
Cotton carrier	17	Joseph nasal saw	68	Scissors, tungsten carbide	53 - 54
Cottle alar retractor	42	Joseph rhinoplasty knife	41	Self-holding speculum with set screw	13
Cottle bone and cartilage crusher	68	Joseph scissors	47 - 48	Senning needle holder	61
Cottle chisel	34 - 35	Joseph skin hook	45	Septum set	77
Cottle columella forceps	58	Kabierske cannula	16	Sinusscopes	5 - 6
Cottle double hook	44	Kabierske powder blower	16	Skin hook	45
Cottle elevator/raspatory	30	Kazanjan rongeur	23	Solution bowl	71
Cottle lower lateral forceps	60	Kidney bowl	72	Sleeve for rubin morcelizer forceps	27
Cottle lower lateral scissors	55	Killian raspatory, double ended	29	Stevens vascular scissors	51
Cottle mallet	33	Killian-Claus gouge	38	Strümpel-Voss nasal forceps	21
Cottle nasal hook	42	Killian septum speculum	11 - 12	Struycken nasal forceps	24
Cottle nasal rasp	65	Killian-Struycken septum speculum	11	Styilet for nasal polyp snares	14
Cottle nasal scissors	55 - 56	Kilner hook	43	Suction tubes	17 - 18
Cottle-Neivert double hook	42	Kilner rhinoplasty scissors	50 - 51	Tablet dish	71
Cottle osteotome	34 - 35, 38	Kleinert-Kutz nasal rasp	66	Takahashi nasal forceps	21 - 22
Cottle osteotome, flat	34	Krause nasal polyp snare	14	Throughcutting nasal forceps	25
Cottle osteotome with single guard	38	Krause-Voss nasal polyp snare	14	Tieck-Halle nasal speculum	10
Cottle osteotome with 2 guards	35	Kressner turbinate crushing forceps	26	Tolsdorff bone and cartilage crusher	69
Cottle raspatory	30	Lange nasal polyp snare	14	Ulmer raspatory	31
Cottle septum knife	40	Leak tester	7	Ultra-Stop Anti-Fog solution	7
Cottle septum speculum	11 - 13	Lempert raspatory	30 - 31	Universal scissors	54
Cottle skin hook	44 - 45	LED light handles	8	Watson-Williams nasal forceps	22
Cottle thimble hook	43	Mallets	33	Walter gouge	38
Cottle tunnel raspatory	30	Maltz nasal rasp	64 - 65	Walter osteotome	36
Cottle-Walsham septum straightening forceps	27	Masing elevator/raspatory	29	Walter scissors	54
Craig septum forceps	23	Masing nasal rasp	65	Weber elevator, double ended	29
Craig-Domnick septum forceps	23	Masing needle holder	62	Weber nasal scissors	57
Crile-Wood needle holder	61	Masing osteotome	38 - 39	Westmacott sponge holding forceps	15
Crile-Wood Ryder needle holder	61	Masing pointed knife	40	Wigand polyp-grasping forceps	25
DeBakey dressing forceps	59	McKenty raspatory	31	Wullstein raspatory	31
Endoscope container	74	McKenty raspatory, double ended	29	Wurm osteotome	39
Ferris-Smith nasal forceps	22	Medicine cup	71	Yankauer septum needle	45
Flexible endoscope	9	Medication dish, dappen-glass	72		
Flexible holding arm	13	Metal cup with handle	71		
Fomon alar hook	44	Metal bowl	71		
Fomon nasal rasp	63	Metzenbaum scissors	46, 48 - 50		
Fomon nasal rasp, diamond	65	Micro blades	41		
Fomon nasal scissors	55 - 56	Micro vascular scissors	57		
Forceps, anatomical	60	Micro Adson forceps	59		
Forceps, surgical	60	Micro handle	41		
Forceps holder	72	Micro Ryder needle holder	62		
Frazier suction tubes	18	Miller nasal rasp	64		



20-631-18.....	46	20-801-02.....	63	20-915-01.....	19	30-321-01.....	25	80-632-02.....	73
20-631-20.....	46	20-801-03.....	63	20-915-02.....	19	30-321-02.....	25	80-632-03.....	73
20-632-12.....	55	20-801-04.....	63	20-915-03.....	19	30-322-01.....	25	80-632-04.....	73
20-633-12.....	55	20-801-05.....	63	20-915-04.....	19	30-322-02.....	25	80-632-05.....	73
20-633-14.....	46	20-801-16.....	17	20-915-10.....	19	30-700-00.....	14	80-641-14.....	73
20-633-18.....	46	20-802-16.....	17	20-915-12.....	19	30-700-01.....	14	80-642-00.....	73
20-633-20.....	46	20-803-01.....	64	20-925-01.....	19	30-711-00.....	14	80-642-01.....	73
20-634-14.....	46	20-803-02.....	64	20-925-02.....	19	40-745-18.....	61	80-642-02.....	73
20-634-18.....	46	20-803-03.....	64	20-925-03.....	19	40-480-18.....	61	80-642-03.....	73
20-634-20.....	46	20-803-04.....	64	20-925-04.....	19	70-211-00.....	8	80-642-04.....	73
20-635-13.....	56	20-803-05.....	64	20-935-01.....	19	70-211-01.....	8	80-642-05.....	73
20-635-15.....	46	20-803-06.....	64	20-935-02.....	19	70-211-10.....	8	80-661-12.....	73
20-635-18.....	46	20-803-07.....	64	20-943-01.....	19	70-211-20.....	8	80-661-14.....	73
20-638-16.....	56	20-803-08.....	64	20-943-02.....	19	70-211-30.....	8	80-661-21.....	73
20-639-16.....	56	20-804-00.....	63	20-943-03.....	19	70-211-40.....	8	80-662-00.....	73
20-640-14.....	47	20-804-01.....	63	20-943-04.....	19	70-211-50.....	8	80-662-01.....	73
20-641-14.....	47	20-804-02.....	63	20-943-11.....	19	80-316-50.....	70	80-662-02.....	73
20-642-12.....	46	20-804-03.....	63	20-943-12.....	19	80-317-30.....	70	80-662-03.....	73
20-646-12.....	46	20-804-04.....	63	20-943-13.....	19	80-317-50.....	70	80-662-04.....	73
20-647-12.....	47	20-804-05.....	63	20-945-01.....	22	80-318-30.....	70	80-662-05.....	73
20-648-12.....	47	20-804-06.....	63	20-945-02.....	22	80-318-50.....	70	80-671-20.....	73
20-650-16.....	47	20-804-07.....	63	20-946-01.....	22	80-319-30.....	70	80-671-25.....	73
20-651-18.....	47	20-804-08.....	63	20-946-02.....	22	80-319-50.....	70	80-671-40.....	73
20-680-16.....	56	20-804-09.....	63	25-100-05.....	28	80-320-30.....	70	80-671-60.....	73
20-681-16.....	57	20-804-10.....	63	25-100-21.....	28	80-320-50.....	70	80-675-00.....	74
20-682-16.....	57	20-804-20.....	63	25-100-46.....	28	80-322-30.....	70	80-681-01.....	73
20-683-18.....	56	20-804-99.....	63	30-080-05.....	18	80-322-50.....	70	80-681-02.....	73
20-690-01.....	57	20-805-01.....	64	30-080-06.....	18	80-101-16.....	69	80-681-03.....	73
20-690-02.....	57	20-805-02.....	64	30-080-07.....	18	80-106-16.....	69	80-681-04.....	73
20-690-03.....	57	20-806-01.....	64	30-080-08.....	18	80-111-16.....	69	80-681-05.....	73
20-691-01.....	57	20-806-02.....	64	30-080-09.....	18	80-500-00.....	71	80-681-06.....	73
20-693-00.....	26	20-808-00.....	64	30-080-10.....	18	80-501-01.....	71	80-681-07.....	73
20-693-01.....	26	20-810-21.....	65	30-080-12.....	18	80-501-02.....	71	80-683-10.....	74
20-693-02.....	26	20-811-19.....	65	30-080-15.....	18	80-501-03.....	71	80-684-10.....	74
20-696-11.....	57	20-812-19.....	65	30-081-06.....	18	80-501-04.....	71	80-688-00.....	74
20-700-10.....	58	20-815-21.....	65	30-081-08.....	18	80-503-03.....	71	80-690-01.....	74
20-701-08.....	58	20-816-21.....	65	30-081-09.....	18	80-504-05.....	71	80-690-02.....	74
20-705-14.....	58	20-818-18.....	65	30-081-10.....	18	80-505-10.....	71	80-691-01.....	74
20-710-12.....	58	20-819-18.....	65	30-081-12.....	18	80-505-20.....	71	80-692-01.....	74
20-711-12.....	58	20-820-21.....	65	30-081-15.....	18	80-506-30.....	71	130 400 028ST.....	9
20-712-12.....	59	20-822-21.....	66	30-105-06.....	18	80-507-40.....	71	130 400 034ST.....	9
20-713-12.....	59	20-823-21.....	66	30-105-08.....	18	80-509-75.....	71	130 414 040ST.....	9
20-714-12.....	59	20-824-21.....	66	30-105-10.....	18	80-512-00.....	71		
20-715-12.....	59	20-825-18.....	66	30-130-00.....	6	80-515-06.....	71		
20-716-12.....	59	20-826-21.....	66	30-130-30.....	6	80-515-08.....	71		
20-718-11.....	60	20-827-21.....	66	30-130-70.....	6	80-515-10.....	71		
20-720-14.....	60	20-828-17.....	66	30-132-00.....	6	80-519-00.....	72		
20-722-15.....	60	20-829-17.....	66	30-132-30.....	6	80-519-01.....	72		
20-730-16.....	17	20-830-21.....	66	30-132-45.....	6	80-519-02.....	72		
20-730-19.....	17	20-850-17.....	67	30-134-00.....	6	80-519-03.....	72		
20-730-21.....	17	20-851-18.....	67	30-134-30.....	6	80-520-06.....	72		
20-740-15.....	61	20-852-07.....	67	30-134-45.....	6	80-520-08.....	72		
20-742-13.....	61	20-853-03.....	67	30-134-70.....	6	80-525-17.....	72		
20-744-15.....	61	20-853-04.....	67	30-135-00.....	6	80-525-25.....	72		
20-744-17.....	61	20-856-17.....	68	30-135-30.....	6	80-528-13.....	72		
20-745-15.....	62	20-860-01.....	68	30-142-45.....	6	80-528-18.....	72		
20-746-12.....	62	20-860-02.....	68	30-142-90.....	6	80-528-20.....	72		
20-748-10.....	62	20-860-03.....	68	30-160-01.....	7	80-530-20.....	72		
20-748-11.....	62	20-865-30.....	68	30-160-02.....	7	80-631-10.....	73		
20-748-13.....	62	20-865-50.....	68	30-160-03.....	7	80-631-12.....	73		
20-764-09.....	62	20-867-40.....	69	30-160-05.....	7	80-631-14.....	73		
20-800-16.....	17	20-868-40.....	69	30-169-08.....	7	80-631-21.....	73		
20-801-00.....	63	20-889-18.....	62	30-320-01.....	25	80-632-00.....	73		
20-801-01.....	63	20-915-00.....	19	30-320-02.....	25	80-632-01.....	73		



Umrechnungstabelle - Ch/Fr - mm - inch

Conversion table - Ch/Fr - mm - inch

Charrière (CH) French (F)	mm	Inch
1	0,33	0,013
2	0,67	0,025
3	1,00	0,039
4	1,33	0,051
5	1,67	0,065
6	2,00	0,079
7	2,33	0,092
8	2,67	0,105
9	3,00	0,118
10	3,33	0,131
11	3,67	0,144
12	4,00	0,156
13	4,33	0,170
14	4,67	0,184
15	5,00	0,197
16	5,33	0,210
17	5,67	0,223
18	6,00	0,237
19	6,33	0,249
20	6,67	0,263
21	7,00	0,276
22	7,33	0,288
23	7,67	0,302
24	8,00	0,315
25	8,33	0,328
26	8,67	0,341
27	9,00	0,354
28	9,33	0,367
29	9,67	0,380
31	10,23	0,407
32	10,67	0,420
34	11,33	0,446
36	12,00	0,472
38	12,67	0,494
40	13,33	0,520
45	15,00	0,591

Größenvergleich der Blätter von Nasenspekula

Specula blades size comparison

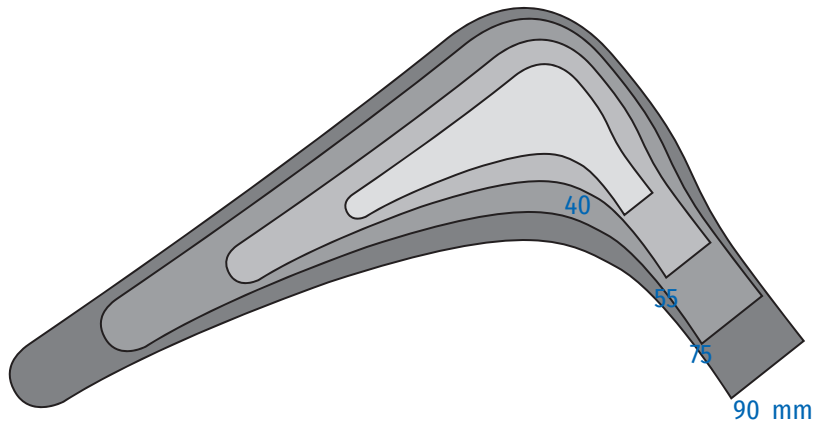

© 2023 by SPIGGLE & THEIS Medizintechnik GmbH

Änderungen und Irrtümer – einschließlich Bilder - vorbehalten.
Produktsortiment kann pro Land abweichen.

Modifications and errors - including pictures - reserved.
Product range might vary per country.



Burghof 14 · 51491 Overath · Germany
Phone: +49 2206 90 81 - 0
Fax: +49 2206 90 81 - 13
info@spiggle-theis.com
www.spiggle-theis.com