

Otologie Instrumentarium

Otology Instruments



Quality you can rely on

30
Years
SPIGGLE & THEIS
1994 - 2024





Über uns

About Us

Herzlich willkommen in unserem Instrumentenkatalog.

Bevor Sie in die Welt unserer ‚MADE IN GERMANY‘ Instrumente eintauchen, möchten wir Ihnen einen kurzen Einblick in unsere Erfolgsgeschichte gewähren.

Was vor 30 Jahren als überschaubares Handelsunternehmen begann, hat sich seitdem zu einem weltweit etablierten Hersteller erstklassiger **HNO-Instrumente und Verbrauchsmaterialien** entwickelt.

Unsere Geschichte ist geprägt von einer tiefen Hingabe zur Hals-, Nasen- und Ohrenchirurgie sowie von kontinuierlicher Weiterentwicklung. **Unsere Leidenschaft** zur HNO spiegelt sich wider in der Partnerschaft mit den medizinischen Fachkräften, die ein integraler Bestandteil unseres Netzwerks und unserer Innovationskraft sind.

Einen weiteren Schlüssel unseres Erfolges stellen **unsere Mitarbeiter** dar, von denen einige bereits seit Jahrzehnten Teil unseres Unternehmens sind. Ihre Fachkompetenz und kontinuierlicher Einsatz haben es uns ermöglicht, zusammen mit Ihnen neue Produkte zu entwickeln und fortlaufend zu verbessern.

2020 ist die **SPIGGLE & THEIS Medizintechnik GmbH** mehrheitlich von der **Thyssen'schen Handelsgesellschaft** übernommen worden, wodurch der weitere Ausbau des Unternehmens, unter Berücksichtigung unserer Innovationskraft und des Qualitätsversprechens, sichergestellt ist. Mit diesem starken Partner an unserer Seite eröffnen sich neue Horizonte, die uns unsere Visionen schneller umsetzen lassen und den Kundenanforderungen noch besser gerecht werden.

Dieser Katalog präsentiert **hochwertige Instrumente**, die auf den Bedürfnissen unserer Kunden und Partner aus der HNO-Medizin basieren. Wir hoffen, dass Sie unser Produktportfolio überzeugt und Sie hier das passende Instrument für Ihre Anforderung finden.

Wir danken Ihnen herzlich für Ihre **Treue** und Ihr **Vertrauen**.

Ihr SPIGGLE & THEIS Team

Welcome to our instrument catalog.

Before you immerse yourself in the world of our ‚MADE IN GERMANY‘ instruments, allow us to offer a brief glimpse into our success story.

What began as a modest trading company three decades ago has since developed into a globally recognized manufacturer of top-tier **ENT instruments and consumables**.

Our history is defined by a profound dedication to ENT surgery, healing practices, and continuous growth. **Our passion** resonates perfectly with the physicians, specialists, and medical professionals who are integral to our network and innovative spirit.

Another vital aspect of our success is **our employees**, some of whom have been with our company for decades. Their expertise and unwavering dedication have empowered us to collaborate with you in developing and consistently enhancing new products.

In 2020, **SPIGGLE & THEIS Medizintechnik GmbH** was primarily acquired by **Thyssen'sche Handelsgesellschaft**, ensuring the company's continued expansion while prioritizing our innovative capacity and commitment to quality. With this robust partnership at our side, new horizons have emerged, accelerating the realization of our visions and enhancing our ability to meet customer demands more efficiently.

This catalog showcases **premium instruments** tailored to the needs of our clients and partners in the field of ENT medicine. We hope you discover the perfect instrument that meets your requirements and allows our commitment to quality to speak for itself.

Thank you very much for your **loyalty** and **trust**.

Your SPIGGLE & THEIS Team



Inhaltsverzeichnis

Table of contents

01	Ambulantes Ohr-Instrumentarium / Diagnostic Ear Instruments	5 - 26
02	Antrotomie / Antrotomy	27 - 31
03	Rotierende Instrumente / Rotary Instruments	32
04	Wundsperrer / Retractors	33 - 36
05	Pinzetten / Dressing Forceps	37 - 41
06	Scheren / Scissors	42 - 45
07	Mikrochirurgische Instrumente / Microsurgery Instruments	46 - 55
07a	Titan-Instrumente nach Prof. Wollenberg / Prof. Wollenberg Titanium Instruments	56 - 57
07b	Endoskopische / Mikroskopische Instrumente nach Prof. Panetti Endoscopic / Microscopic Instruments by Prof. Panetti.....	58 - 64
08	Ohrzängchen / Ear Forceps	65 - 70
09	Mess- und Kürzinstrumente / Measuring and Shortening Instruments	71 - 73
10	Allgemeines / Miscellaneous	74 - 80
11	Sterilisationssysteme / Sterilization Systems	81 - 85
12	Sets	86 - 92
	Index	94 - 97

Attention:

Not every instrument is available in all markets. Availability depends on local regulations. Please contact your SPIGGLE & THEIS representative or distributor, if you have any questions about the availability of our products in your region.

01 Ambulantes Ohr-Instrumentarium

Diagnostic Ear Instruments

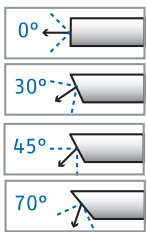

Otoskop, HD, autoklavierbar / Otoscope, HD, autoclavable

Art.-Nr. Art.-No.	Größe Size (mm)	Länge Length (cm)	Winkel Angle
10-102-00	2,7	5,0	0°
10-102-30	2,7	5,0	30°
10-104-00	2,4	9,8	0°
10-104-30	2,4	9,8	30°

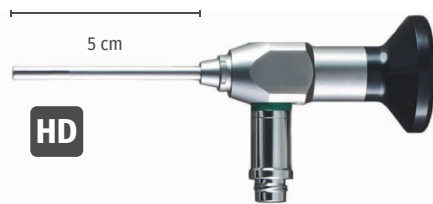
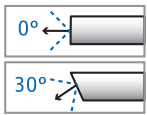

Gehörgangs-Endoskop, HD, autoklavierbar, AD 4 mm, 5 cm Ear canal endoscope, HD, autoclavable, OD 4 mm, 5 cm

Art.-Nr./No.	Winkel / Angle
10-106-00	0°
10-107-30	30°



Gehörgangs-Endoskop mit Ohrspekulum, HD, autoklavierbar, AD 4 mm, 5 cm Ear canal endoscope with ear speculum, HD, autoclavable, OD 4 mm, 5 cm

Art.-Nr./No.	Winkel / Angle
10-108-00	0°
10-108-99	Ersatzspekulum für 10-108-00 spare speculum for 10-108-00

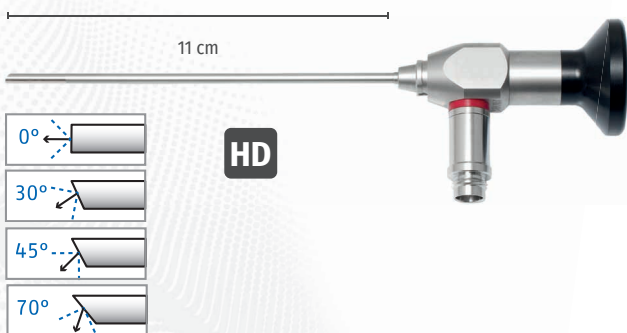

Otoskop, HD, Großbild, autoklavierbar, AD 3 mm, 11 cm Otoscope, HD, large picture, autoclavable, OD 3 mm, 11 cm

Art.-Nr./No.	Winkel / Angle
10-109-00	0°
10-109-30	30°
10-109-45	45°
10-109-70	70°

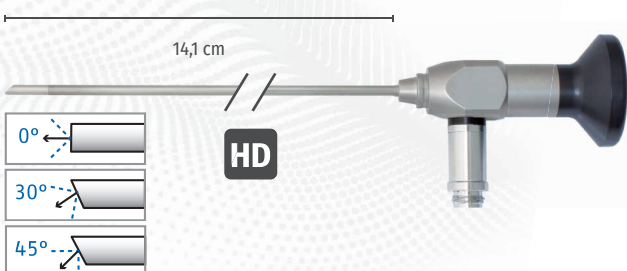

Otoskop, HD, Großbild, autoklavierbar, AD 3 mm, 14,1 cm Otoscope, HD, large picture, autoclavable, OD 3 mm, 14.1 cm

Art.-Nr./No.	Winkel / Angle
10-090-00	0°
10-090-30	30°
10-090-45	45°



01 Ambulantes Ohr-Instrumentarium

Diagnostic Ear Instruments

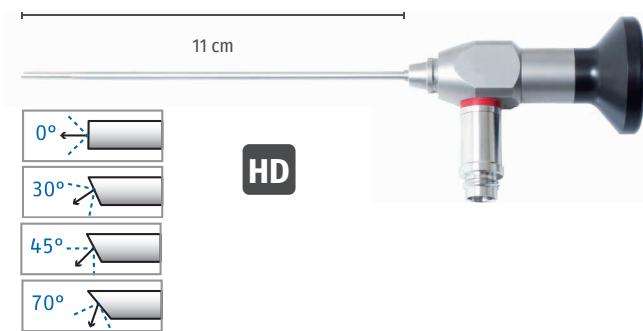

Otoskop, HD, Großbild, autoklavierbar, AD 2,4 mm, 11 cm

Otoscope, HD, large picture, autoclavable, OD 2.4 mm, 11 cm

Art.-Nr./No.	Winkel / Angle
10-111-00	0°
10-111-30	30°
10-111-45	45°
10-111-70	70°

LED-Leuchtgriffe / LED light handles

Art.-Nr./No.

70-211-00 LED-Hochleistungs-Leuchtgriff, 230 V, bestehend aus: (70-211-10, 70-211-20, 70-211-30, 70-211-40)
LED high performance light-handle, 230 V, consisting of:
(70-211-10, 70-211-20, 70-211-30, 70-211-40)

70-211-01 LED-Hochleistungs-Leuchtgriff, 120 V, bestehend aus: (70-211-10, 70-211-20, 70-211-30, 70-211-50)
LED high performance light-handle, 120 V, consisting of:
(70-211-10, 70-211-20, 70-211-30, 70-211-50)

70-211-10 LED-Handgriff, schwarz, mit Helligkeitsdimmer, Ausschaltautomatik, 3 W, 5500° K, 17500 Lux, zur Verwendung mit Li-Io-Akku 3,7 V und Endoskop-Adapter, 50 Std. Brenndauer
LED light handle, black, with brightness dimmer, automatic switch-off, 3 W, 5500° K, 17500 lux, to use with Li-ion chargeable battery 3.7 V and endoscope adapter, 50 hours run-time

70-211-20 Li-Ionen-Akku, 3,7 V, für LED-Handgriff
Li-ion rechargeable battery, 3.7 V, for LED light-handle

70-211-30 Endoskopie-Adapter für LED-Handgriff, passend für Standardgewinde an Endoskopen (AcMI-Gewinde)
Endoscope adapter for LED light-handle, fits standard endoscope threads (AcMi-thread)

70-211-40 Ladegerät für bis zu 2 LED-Handgriffe, 3,5 V, 230 V, Standgerät, Wandhalterung
Charging base for up to 2 LED light-handles, 3.5 V, 230 V, table model, with wall holder

70-211-50 Ladegerät für bis zu 2 LED-Handgriffe, 3,5 V, 120 V, Standgerät, Wandhalterung
Charging base for up to 2 LED light-handles, 3.5 V, 120 V, table model, with wall holder



01 Ambulantes Ohr-Instrumentarium

Diagnostic Ear Instruments



**Halogen Super Spot Stirnlampe
mit integriertem Lichtleitkabel, Kabellänge 2,30 m**
Halogen Super Spot headlight with integrated light cable,
length of cable 2.30 m

10-110-00

**Lichtleiter mit Irisblende für Kaltlicht-Stirnlampe
10-110-00 (ohne Stirnreifen), mit Storz-Adapter**
Light cable with iris, for headlight 10-110-00
(without headband), with Storz adapter

10-110-03



**Kabellose Hochleistungs-LED Stirnlampe
"HighLite" mit Komfort-Stirnreifen, Ladegerät**
Cordless high definition LED headlight "HighLite",
comfortable headband, transformer and charger

Art.-Nr./No.	Beschreibung / Description
10-120-00	Mit integriertem Akku-Pack with integrated battery pack
10-122-00	Mit mobilem Akku-Pack with mobile battery pack



**HR-Binokularlupe 2,5 x / 340 mm mit Spritzschutz und
schwenkbarem Lupenträger, Nachrüstsatz für "HighLite"**
HR binocular loupe 2.5 x / 340 mm with cover and
loupe holder, attachment for "HighLite"

10-120-01



Stirnlampen-Ladestation, EN50 unplugged
Headlight transformer, EN50 unplugged

10-120-10



01 Ambulantes Ohr-Instrumentarium

Diagnostic Ear Instruments



ENTERVIEW III, Kabellose- LED Stirnleuchte
ENTERVIEW III, cordless LED headlight

10-126-01

Akkuladegerät und Stirnleuchtenhalter für ENTERVIEW III
Battery charger and headlight rest for ENTERVIEW III

80-729-01



Kombi-Tasche für LED-Leuchte
Bag for LED headlight

10-120-99

Kopfband Professional L für HR und HRP Optiken
Headband Professional L for HR and HRP optics

C-000.32.549

01 Ambulantes Ohr-Instrumentarium

Diagnostic Ear Instruments



Binokularlupe, 2,5x Vergrößerung, 34 cm Arbeitsabstand
Binocular loupe, 2.5x magnification, working distance 34 cm

10-140-00



Blessing Nystagmusbrille, mit Batteriegriff, weiß
Blessing Nystagmus spectacles, integrated battery handle, white

10-142-00



Frenzel Nystagmusbrille, schwarz
Frenzel Nystagmus spectacles, black

Art.-Nr./No.	Beschreibung / Description
10-141-00	mit Kabelanschluss / with cable connection
10-141-01	mit Batteriehandgriff / with battery handle
10-141-99	Steckernetzteil für Nystagmusbrille 10-141-00 power supply for Nystagmus spectacles 10-141-00



Mini Otoskop 3000, mit Batteriegriff 2,5 V, Batterien,
4 Dauergebrauchs-Ohrtrichter, 10 Einmal-Ohrtrichter, Etui
Mini otoscope 3000, with battery handle 2.5 V, batteries,
4 multi use ear specula, 10 disposable ear specula, cover

10-143-00



01 Ambulantes Ohr-Instrumentarium

Diagnostic Ear Instruments



XHL Xenon Ersatzlampe, 2,5 V, für Mini Otoskop 3000
XHL xenon spare bulb, 2.5 V, for Mini otoscope 3000

10-143-99



HNO Fiber Otoskop Beta 200, USB Ladegriff mit USB Kabel, Steckernetzteil, 4 Dauergebrauchs-Ohrtrichter, 10 Einmal-Ohrtrichter, Ersatzlampe, Etui
ENT fibre otoscope Beta 200, usb rechargeable handle with usb cable, power supply, 4 multi use ear specula, 10 disposable ear specula, spare bulb, case

10-145-80



XHL Xenon Ersatzlampe, 2,5 V, für Beta 200
XHL xenon spare bulb, 2.5 V, for Beta 200

10-145-98



XHL Xenon Ersatzlampe, 3,5 V, für Beta 200
XHL xenon spare bulb, 3.5 V, for Beta 200

10-145-99

Dauergebrauchs-Ohrtrichter, autoklavierbar, für beta 200 und Mini Otoskop 3000, schwarz
Multi use ear specula, autoclavable, for Beta 200 and Mini Otoscope 3000, black



Art.-Nr./No.	Größe / Size (mm)
10-145-24	2,4
10-145-30	3,0
10-145-40	4,0
10-145-50	5,0
10-145-01	Set bestehend aus / contains: 2,4 mm, 3,0 mm, 4,0 mm, 5,0 mm

01 Ambulantes Ohr-Instrumentarium

Diagnostic Ear Instruments



**Einmal-Ohrtrichter für Otoskope Beta 200
und Mini Otoskop 3000, schwarz, 1000 Stück/Box**
Ear specula, disposable, for otoscopes Beta 200
and Mini otoscope 3000, black, 1000 pieces/box

Art.-Nr./No.	Größe / Size (mm)
10-148-25	2,5
10-148-40	4,0



Politzer Ohrolive / Politzer ear olive

10-151-03



01 Ambulantes Ohr-Instrumentarium

Diagnostic Ear Instruments



Kabierske Pulverbläser, komplett mit drei Kanülen für Ohr, Nase, Rachen, Hals; mit Glas und Ventilball

Kabierske powder blower, complete with three cannulae for ear, nose, pharynx, larynx; with bottle and rubber ball

10-155-00



Kabierske Ersatzglas, 30 ccm

Kabierske spare bottle, 30 ccm

10-155-01



Kabierske Ventilball / Kabierske rubber ball

10-155-02

8 / 11 cm



Kabierske Kanüle, gerade / Kabierske cannula, straight

Art.-Nr./No.	Länge / Length (cm)
10-155-08	8
10-155-11	11

13 cm

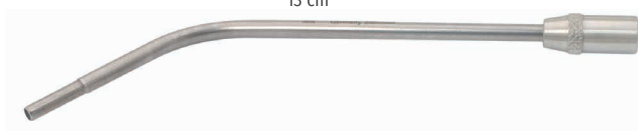

Kabierske Kanüle, gebogen, 13 cm

Kabierske cannula, curved, 13 cm

10-155-13

01 Ambulantes Ohr-Instrumentarium

Diagnostic Ear Instruments



Stimmgabel mit Fuß, a1 = 440 Hz
Tuning fork with foot, a1 = 440 Hz

10-171-01



Lucae Stimmgabel mit Fuß / Lucae tuning fork with foot

Art.-Nr./No.

41	c = 128 Hz
42	c1 = 256 Hz
43	c2 = 512 Hz
44	c3 = 1024 Hz
45	c4 = 2048 Hz
46	c5 = 4096 Hz



Hartmann Stimmgabel / Hartmann tuning fork

Art.-Nr./No.

10-172-00	c = 128 Hz
10-172-01	c1 = 256 Hz
10-172-02	c2 = 512 Hz
10-172-03	c3 = 1024 Hz
10-172-04	c4 = 2048 Hz
10-172-05	c5 = 4096 Hz
10-179-00	Set aus c - c4, mit Etui Set containing c - c4, with case



Brünings anastigmatische Ohrlupe
Set mit Ohrlupe, Gummiball, 4 Trichtern, Etui
Brünings anastigmatic aural magnifier
set with magnifier, rubber bulb, 4 specula, case

10-180-00



Brünings Gummiball, inklusive Schlauch und Steckkonus
Brünings rubber bulb, including tube and cone

10-182-01



01 Ambulantes Ohr-Instrumentarium

Diagnostic Ear Instruments



10-182-02



10-182-04

Brünings Lupe, geschlossen / Brünings loupe head, closed

Art.-Nr./No.	Vergrößerung / Magnification
10-182-02	2,5 x
10-182-04	0

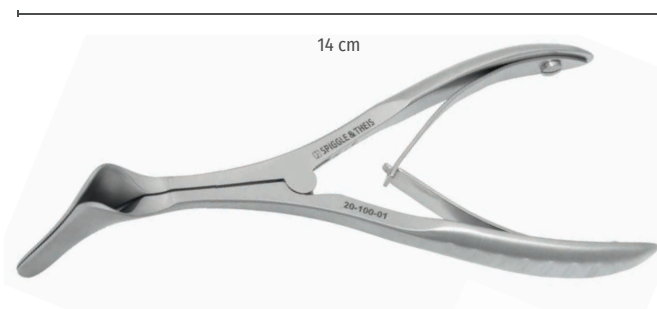

Hartmann Nasenspekulum für Erwachsene, zerlegbar, 14 cm Hartmann nasal speculum for adults, dismountable, 14 cm

20-100-01



10-183-10

10-183-01

10-183-02

10-183-03

10-183-04

Brünings Ohrtrichter / Brünings ear speculum

Art.-Nr./No.	
10-183-10	0
10-183-01	1
10-183-02	2
10-183-03	3
10-183-04	4



Hartmann Ohrtrichter / Hartmann ear speculum

Art.-Nr./No.	Größe / Size	ID / ID (mm)	AD / OD (mm)
10-200-00	0	2,0	3,3
10-200-01	1	3,2	4,3
10-200-02	2	4,0	5,2
10-200-03	3	5,2	6,5
10-200-04	4	6,5	7,8



Hartmann Ohrtrichter zur Nachbehandlung, matt Hartmann ear speculum for post treatment, satin finished

Art.-Nr./No.	Größe / Size	ID / ID (mm)	AD / OD (mm)
10-201-01	1	8	9
10-201-02	2	9	10

01 Ambulantes Ohr-Instrumentarium

Diagnostic Ear Instruments

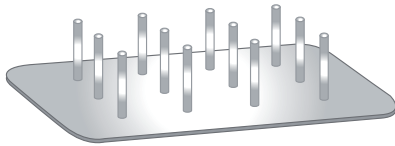

Metallständer mit 12 Aufnahmen für Ohrtrichter

Metal stand with 12 seatings for ear speculum

10-204-99



Farrior Ohrtrichter, rund / Farrior ear speculum, round

Art.-Nr./No.	Größe / Size	ID / ID (mm)	AD / OD (mm)
10-186-01	1	3,3	4,3
10-186-02	2	4,3	5,1
10-186-03	3	4,8	5,6
10-186-04	4	5,3	6,1
10-186-05	5	5,8	6,6
10-186-06	6	6,3	7,1
10-186-07	7	6,7	7,5
10-186-08	8	7,2	8,0
10-186-09	9	7,7	8,7



Farrior Ohrtrichter, oval, schwarz, 20°

Farrior ear speculum, oval, black, 20°

Art.-Nr./No.	Größe / Size	ID / ID (mm)	AD / OD (mm)
10-188-01	1	3,0 x 4,0	4,0 x 5,0
10-188-02	2	4,0 x 5,0	5,0 x 6,0
10-188-03	3	4,5 x 5,5	5,5 x 6,5
10-188-04	4	5,0 x 6,0	6,0 x 7,0
10-188-05	5	5,5 x 6,5	6,5 x 7,5
10-188-06	6	6,0 x 7,0	7,0 x 8,0
10-188-07	7	6,5 x 7,5	7,5 x 8,5
10-188-08	8	7,0 x 8,0	8,0 x 9,0
10-188-09	9	7,5 x 8,5	8,5 x 9,5



Farrior Ohrtrichter, oval, schwarz, 35°

Farrior ear speculum, oval, black, 35°

Art.-Nr./No.	Größe / Size	ID / ID (mm)	AD / OD (mm)
10-190-01	1	3,0 x 4,0	4,0 x 5,0
10-190-02	2	4,0 x 5,0	5,0 x 6,0
10-190-03	3	4,5 x 5,5	5,5 x 6,5
10-190-04	4	5,0 x 6,0	6,0 x 7,0
10-190-05	5	5,5 x 6,5	6,5 x 7,5
10-190-06	6	6,0 x 7,0	7,0 x 8,0
10-190-07	7	6,5 x 7,5	7,5 x 8,5
10-190-08	8	7,0 x 8,0	8,0 x 9,0
10-190-09	9	7,5 x 8,5	8,5 x 9,5



01 Ambulantes Ohr-Instrumentarium

Diagnostic Ear Instruments



Zöllner Ohrtrichter, Leichtmetall, schwarz

Zöllner ear speculum, light metal, black

Art.-Nr./No.	Größe / Size	ID / ID (mm)	AD / OD (mm)
10-192-01	1	4,5 x 5,5	5,5 x 6,5
10-192-02	2	5,5 x 6,5	6,5 x 7,5
10-192-03	3	6,5 x 7,5	7,5 x 8,5
10-192-04	4	7,5 x 8,5	8,5 x 9,5
10-192-05	5	8,5 x 9,5	9,5 x 10,5
10-192-06	6	9,5 x 10,5	10,5 x 11,5



Politzer Ohrtrichter für Kinder / Politzer ear speculum for infants

Art.-Nr./No.	Größe / Size	ID / ID (mm)	AD / OD (mm)
10-202-01	1	2,0	3,0
10-202-02	2	3,0	4,5
10-202-03	3	4,0	5,5



Holmgren Ohrtrichter, spreizbar, schwarz

Holmgren ear speculum, expandable, black

Art.-Nr./No.	Größe / Size	ID / ID (mm)	AD / OD (mm)
10-203-05	1	4	5
10-203-06	2	5	6
10-203-07	3	6	7



Toynee Ohrtrichter

Toynee ear speculum

Art.-Nr./No.	Größe / Size	ID / ID (mm)	AD / OD (mm)
10-194-01	1	3,2	4
10-194-02	2	4	5
10-194-03	3	5,3	6



Gruber Ohrtrichter, oval

Gruber ear speculum, oval

Art.-Nr./No.	Größe / Size	ID / ID (mm)
10-195-01	1	3,8 x 4,8
10-195-02	2	5 x 6,2
10-195-03	3	6 x 7,2

01 Ambulantes Ohr-Instrumentarium

Diagnostic Ear Instruments

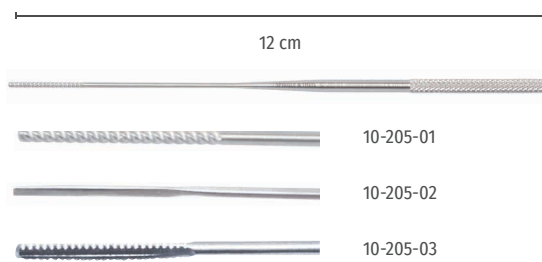

Watteträger, Spitze 1,2 mm, 12 cm, 5 Stück
Cotton carrier, tip 1.2 mm, 12 cm, 5 pieces

Art.-Nr./No.	Beschreibung / Description
10-205-01	gerieft / serrated
10-205-02	dreikant, glatt / triangular, smooth
10-205-03	dreikant, gerieft / triangular, serrated

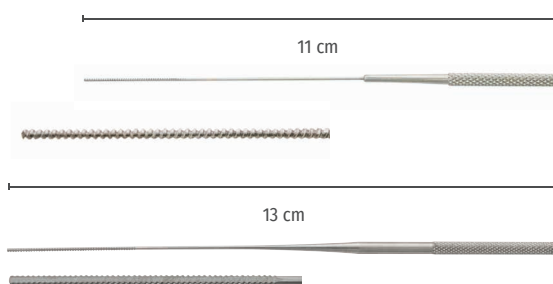

Attik Watteträger, extra fein, gerieft, Ø 0,8 mm, 11 cm, 5 Stück
Atticus cotton carrier, very fine, serrated, Ø 0.8 mm, 11 cm, 5 pieces

10-205-04

Watteträger, dreikant, gerieft, Ø 0,9 mm, 13 cm, 5 Stück
Cotton carrier, triangular, serrated, Ø 0.9 mm, 13 cm, 5 pieces

10-206-13-05

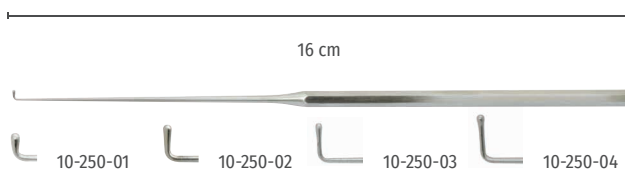

Lucae Cerumenhäkchen, 16 cm / Lucae cerumen hook, 16 cm

Art.-Nr./No.	Größe / Size
10-250-01	1 (2 mm)
10-250-02	2 (3 mm)
10-250-03	3 (4 mm)
10-250-04	4 (5 mm)

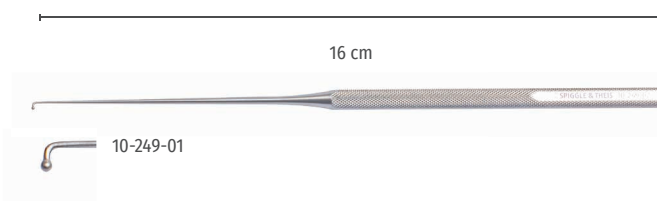

Wagener Cerumenhäkchen, Kugelform, 16 cm /
Wagener cerumen hook, spherical shape, 16 cm

Art.-Nr./No.	Größe / Size
10-249-01	1 (2 mm)
10-249-02	2 (3 mm)
10-249-03	3 (4 mm)
10-249-04	4 (5 mm)
10-249-05	5 (6 mm)

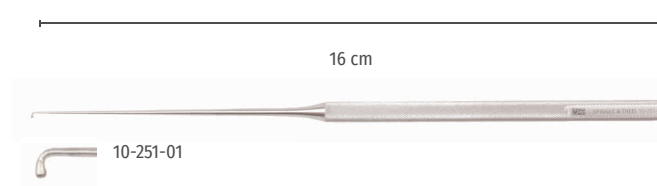

Wagener Cerumenhäkchen, Tropfenform, 16 cm /
Wagener cerumen hook, teardrop shape, 16 cm

Art.-Nr./No.	Größe / Size
10-251-01	1 (2 mm)
10-251-02	2 (3 mm)
10-251-03	3 (4 mm)
10-251-04	4 (5 mm)
10-251-05	5 (6 mm)



01 Ambulantes Ohr-Instrumentarium

Diagnostic Ear Instruments

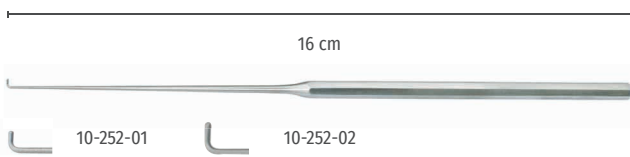

Day Cerumenhäkchen, 16 cm / Day cerumen hook, 16 cm

Art.-Nr./No.	Größe / Size
10-252-01	1 (2,5 mm)
10-252-02	2 (3,5 mm)

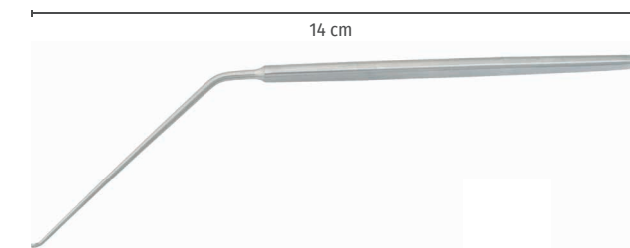

Ohrkürette, Schaft kniegebogen, 14 cm / Ear curette, shaft angled, 14 cm

Art.-Nr. Art.-No.	Größe Size	Winkel Angle
10-258-00	0	Ring 35° aufwärts, stumpf / upwards, blunt
10-258-01	1	Ring 35° aufwärts, stumpf / upwards, blunt
10-258-02	2	Ring 35° aufwärts, stumpf / upwards, blunt
10-258-03	3	Ring 35° aufwärts, stumpf / upwards, blunt
10-259-00	0	Ring gerade, stumpf / straight, blunt
10-259-01	1	Ring gerade, stumpf / straight, blunt
10-259-02	2	Ring gerade, stumpf / straight, blunt
10-259-03	3	Ring gerade, stumpf / straight, blunt



Billeau Ohrschlinge, gerade, 16,5 cm / Billeau ear loop, straight, 16,5 cm

Art.-Nr./No.	Größe / Size
10-263-01	1
10-263-02	2
10-263-03	3



Buck Ohrkürette, leicht gebogen, 16 cm / Buck ear curette, slightly curved, 16 cm

Art.-Nr./No.	Größe / Size	Beschreibung / Description
10-260-20	00 (1,5 mm)	stumpf / blunt
10-260-10	0 (2,0 mm)	stumpf / blunt
10-260-01	1 (2,5 mm)	stumpf / blunt
10-260-02	2 (3,0 mm)	stumpf / blunt
10-260-03	3 (4,0 mm)	stumpf / blunt
10-261-20	00 (1,5 mm)	scharf / sharp
10-261-10	0 (2,0 mm)	scharf / sharp
10-261-01	1 (2,5 mm)	scharf / sharp
10-261-02	2 (3,0 mm)	scharf / sharp
10-261-03	3 (4,0 mm)	scharf / sharp

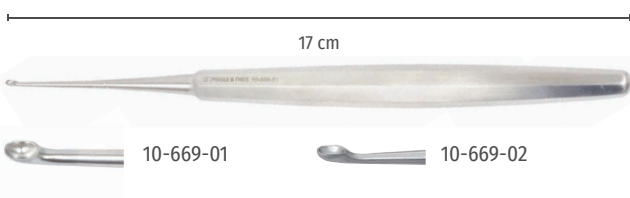

Gehörgangskürette, scharf, 17 cm / Ear canal curette, sharp, 17 cm

Art.-Nr./No.	Größe / Size (mm)
10-669-01	1,8
10-669-02	2,1

01 Ambulantes Ohr-Instrumentarium

Diagnostic Ear Instruments

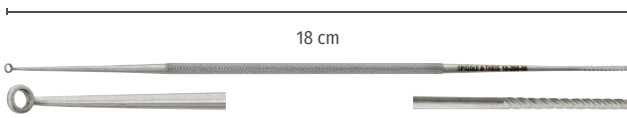

Jobson Watteträger / Kürette, 18 cm
Jobson cotton carrier / curette, 18 cm

10-208-00

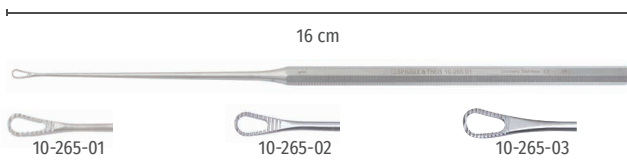

Snellen Ohrschlinge, gebogen, gerieft, 16 cm
Snellen ear loop, curved, serrated, 16 cm

Art.-Nr./No.	Größe / Size (mm)
10-265-01	1
10-265-02	2
10-265-03	3



Ohr-Tamponade-Stopfer Modell Großhadern, 18 cm
Gauze applicator type Großhadern, 18 cm

10-268-18



Hartmann Tamponadezängchen, Schaft 6 cm
Hartmann ear tampon forceps, shaft 6 cm

Art.-Nr./No.	Beschreibung / Description
10-269-01	fein / fine
10-269-02	extra fein / extra fine

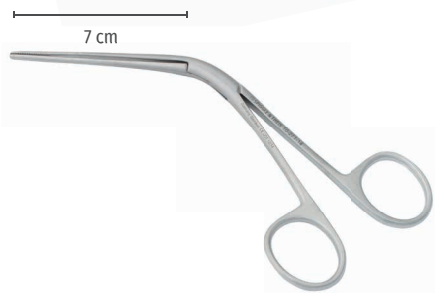

Tilley Ohrtamponadezängchen, Schaft 7 cm
Tilley dressing and sponge holding forceps, shaft 7 cm

10-271-14

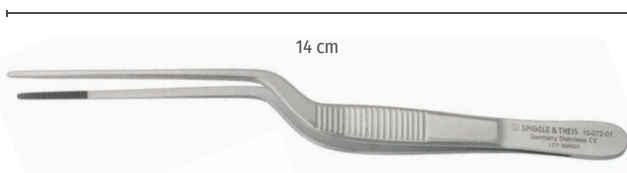

Lucae Ohrpinzette, bajonett, 14 cm
Lucae dressing forceps, bayonet, 14 cm

Art.-Nr./No.	Beschreibung / Description
10-272-01	2 mm, fein / 2 mm, fine
10-272-02	1 mm, extra fein / 1 mm, extra fine

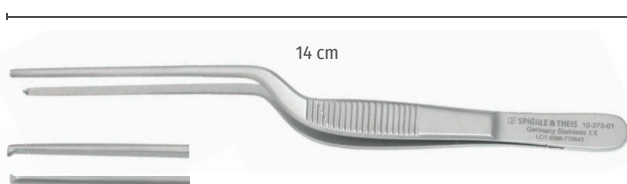

Lucae Ohrpinzette, bajonett, fein, 1:2 Zähne, 2 mm, 14 cm
Lucae dressing forceps, bayonet, fine, 1:2 teeth, 2 mm, 14 cm

10-273-01



01 Ambulantes Ohr-Instrumentarium

Diagnostic Ear Instruments



Troeltsch Ohrpinzette, kniegebogen
Troeltsch dressing forceps, angled

Art.-Nr./No.	Spitze / tip (mm)	Länge / Length (cm)
10-274-00	2,0	13
10-274-01	2,0	11
10-274-02	2,0	15
10-274-03	1,7	17



Hartmann Ohrzängchen, gerade, gerieft, 8 x 1,8 mm, 8 cm
Hartmann ear forceps, straight, serrated, 8 x 1.8 mm, 8 cm

10-276-00

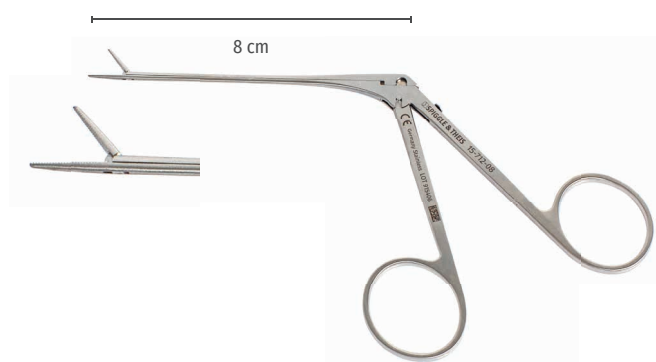

Hartmann Ohrzängchen, gerade, fein, gerieft, 1,2 x 8,0 mm, 8 cm
Hartmann ear forceps, straight, fine, serrated, 1.2 x 8.0 mm, 8 cm

15-712-08



Hartmann Ohrzängchen, gerieft, gerade, 1:2 Zähne, 2,5 x 10 mm, 8,5 cm

Hartmann ear forceps, serrated, straight, 1:2 teeth, 2.5 x 10 mm, 8.5 cm

10-276-01

01 Ambulantes Ohr-Instrumentarium

Diagnostic Ear Instruments

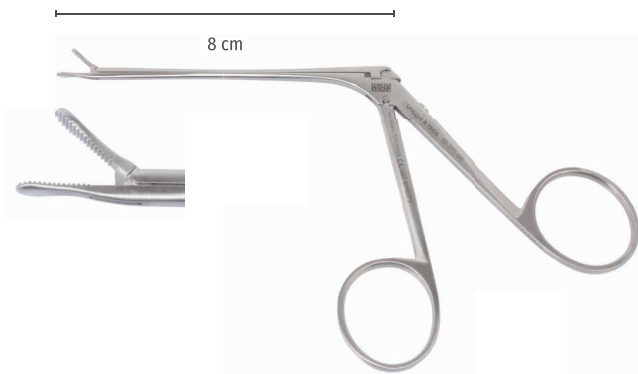

Duckbill Ohrzängchen, schnabelförmig, gerieft, 8 cm
Duckbill ear forceps, flat jaws, serrated, 8 cm

10-277-00

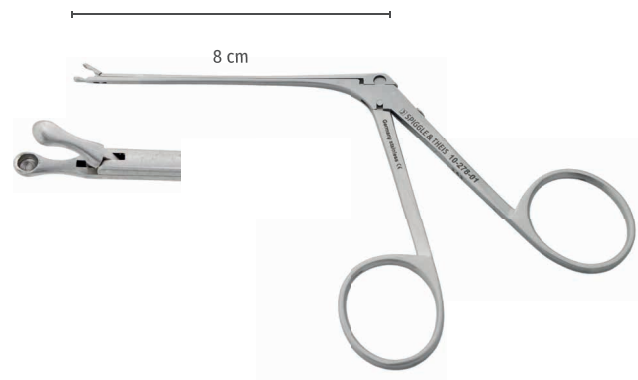

Hartmann Ohrzängchen, runde Löffel, 8 cm
Hartmann ear forceps, round cups, 8 cm

Art.-Nr./No.	Größe / Size
10-278-01	1 (1,5 mm)
10-278-02	2 (2,0 mm)
10-278-03	3 (2,5 mm)
10-278-04	4 (3,0 mm)



Hoffmann Ohrzängchen, durchschneidend, rund, 8 cm
Hoffmann ear forceps, throughcutting, round, 8 cm

Art.-Nr. Art.-No.	Größe Size (mm)	Winkel Angle
10-279-00	2,5	gerade / straight
10-279-01	2,0	gerade / straight
10-279-45	2,0	45° aufwärts / 45° upwards

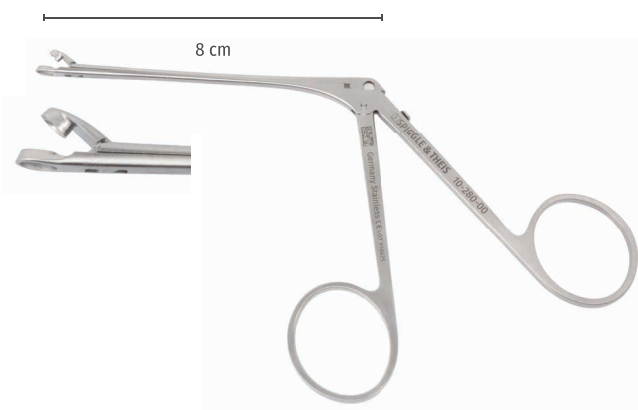

Hoffmann Ohrzängchen, durchschneidend, oval, 1,8 x 3,4 mm, 8 cm
Hoffmann ear forceps, throughcutting, oval, 1,8 x 3,4 mm, 8 cm

10-280-00



01 Ambulantes Ohr-Instrumentarium

Diagnostic Ear Instruments

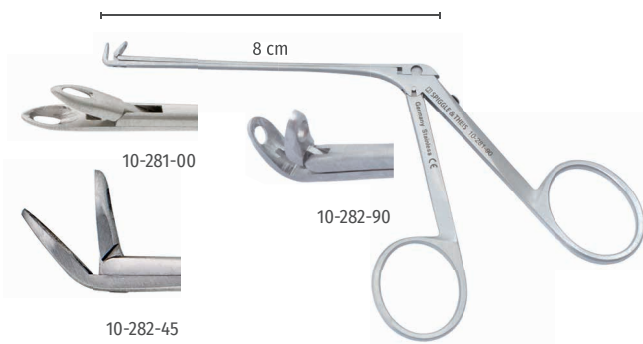

Strümpel Ohrzängchen, oval, gefenestert
Strümpel ear forceps, oval, fenestrated

Art.-Nr. Art.-No.	Größe Size (mm)	Winkel Angle
10-281-00	7,5 x 2,5 mm, 8,0 cm	0°
10-282-45	6,5 x 2,5 mm, 8,7 cm	45°
10-282-90	6,0 x 2,5 mm, 8,7 cm	90°

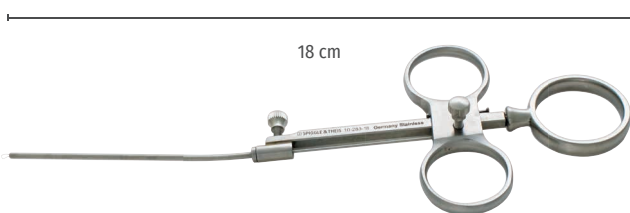

Krause Ohrpolypenschnürer, 18 cm
Krause ear polyp snare, 18 cm

10-283-18



Führungsrohr für Krause Ohrpolypenschnürer, 8,5 cm
Cannula for Krause ear polyp snare, 8.5 cm

10-283-98

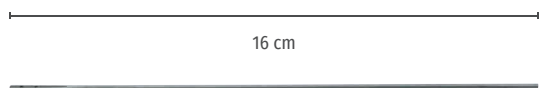

Schlingenführer für Krause Ohrpolypenschnürer, 16 cm
Stylet for Krause ear polyp snare, 16 cm

10-283-99



Schlingen für Krause Ohrpolypenschnürer, 0,2 mm, 9,5 cm
Wire loops for Krause ear polyp snare, 0.2 mm, 9.5 cm

Art.-Nr./No.	Stück / Pieces
10-284-12	12
10-284-00	100

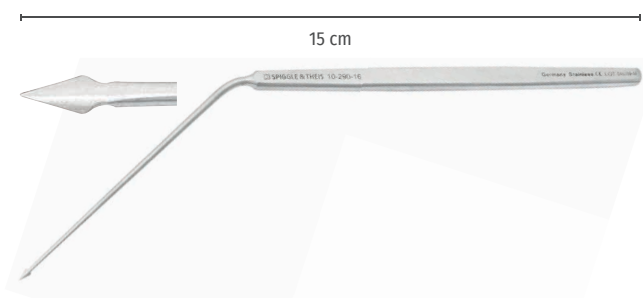

Poltzer Parazentesemesser, kniegebogen, 15 cm
Poltzer myringotomy blade, angled, 15 cm

10-290-16

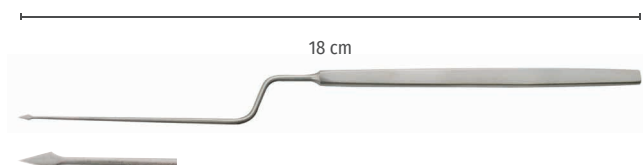

Lucae Parazentesemesser, bajonett, gebogen, 18 cm
Lucae myringotomy blade, bayonet, angled, 18 cm

10-291-18

01 Ambulantes Ohr-Instrumentarium

Diagnostic Ear Instruments

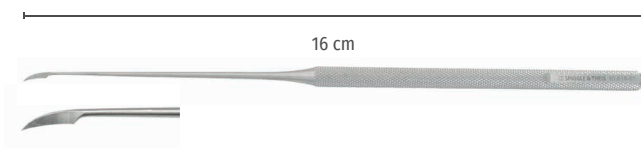

Wullstein Sichelmesser, leicht gebogen, fein, 16 cm
Wullstein sickle knife, slightly curved, delicate, 16 cm

10-618-01

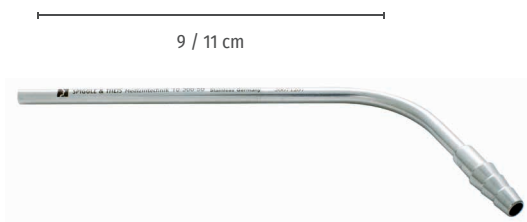

Saugrohr, kniegebogen, zylindrisch
Suction tube, angled, cylindrical

Art.-Nr./No.	AD / OD (mm)	Länge / Length (cm)
10-300-10	1,0	9
10-300-15	1,5	9
10-300-20	2,0	9
10-300-25	2,5	11
10-300-30	3,0	11
10-300-35	3,5	11
10-300-40	4,0	11
10-300-50	5,0	11



Saugrohr, kniegebogen, konisch
Suction tube, angled, conical

Art.-Nr./No.	AD / OD (mm)	Länge / Length (cm)
10-302-30	3,0	11
10-302-35	3,5	11
10-302-45	4,5	13



Saugrohr, gerade, biegsam, konisch, 3,0 mm, 19,5 cm
Suction tube, straight, bendable, conical, 3.0 mm, 19.5 cm

10-303-18



Wullstein Saughandgriff mit Unterbrecher, 10 cm
Wullstein suction handle with suction control, 10 cm

10-305-11



House Saughandgriff mit Unterbrecher, 5 cm
House suction handle with suction control, 5 cm

10-306-05

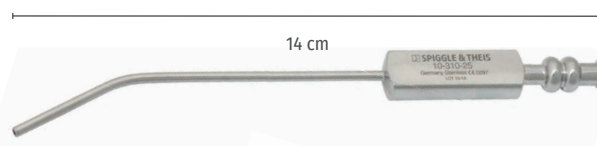

Zöllner Saugrohr, gewinkelt, 2,5 mm, 14 cm
Zöllner suction tube, angled, 2.5 mm, 14 cm

10-310-25



01 Ambulantes Ohr-Instrumentarium

Diagnostic Ear Instruments

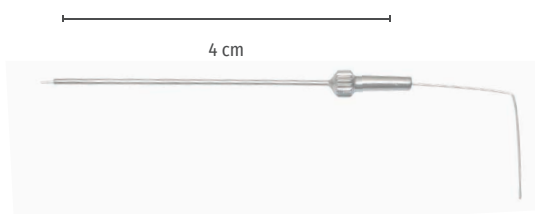

Zöllner Aufsatzsauger mit Mandrin, 0,7 mm, 4 cm
Zöllner suction tip with stylet, 0.7 mm, 4 cm

10-310-07

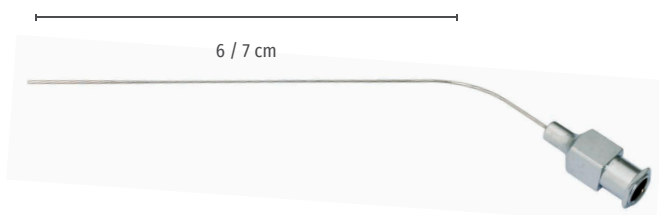

House Nadelsauger, Luer-Lock, 5 Stück/Box
House suction cannula, Luer-Lock, 5 pieces/box

Art.-Nr./No.	AD / OD (mm)		Länge / Length (cm)
10-308-06-05	0,6	◦	7
10-308-08-05	0,8	◦	7
10-308-10-05	1,0	◦	7
10-308-12-05	1,2	◦	7
10-308-15-05	1,5	◦	7
10-308-18-05	1,8	○	7
10-308-20-05	2,0	○	7
10-308-22-05	2,2	○	7
10-308-25-05	2,5	○	7
10-308-30-05	3,0	○	7
10-309-06-05	0,6	◦	6
10-309-08-05	0,8	◦	6
10-309-10-05	1,0	◦	6
10-309-12-05	1,2	◦	6

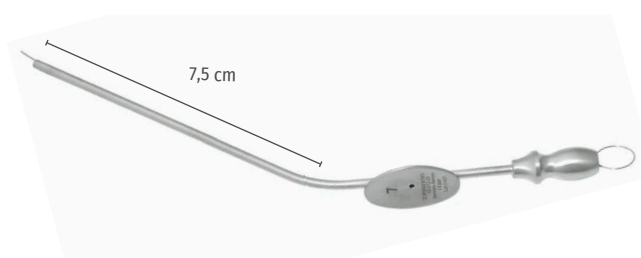

Baron Saugrohr mit Griffplatte und Unterbrecher, 7,5 cm
Baron suction tube with suction control, 7.5 cm

Art.-Nr./No.	AD / OD (mm)
10-312-10	1,0
10-312-17	1,5
10-312-23	2,3



Schuknecht Saugrohr mit Unterbrecher, 45°, 9 cm
Schuknecht suction tube with suction control, 45°, 9 cm

Art.-Nr./No.	ID / ID (mm)
10-314-20	0,9
10-314-22	0,7
10-314-24	0,6

01 Ambulantes Ohr-Instrumentarium

Diagnostic Ear Instruments

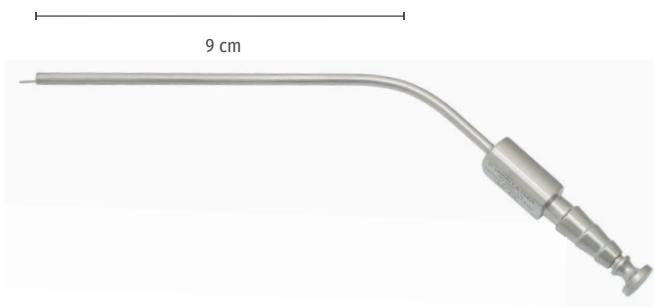

Frazier Saugrohr, mit Griffplatte und Unterbrecher, 9 cm
Frazier suction tube, with suction control, 9 cm

Art.-Nr. Art.-No.		AD / OD Ch/Fr = mm
30-080-05	○	5 = 1,6
30-080-06	○	6 = 2,0
30-080-07	○	7 = 2,3
30-080-08	○	8 = 2,7
30-080-09	○	9 = 3,0
30-080-10	○	10 = 3,3
30-080-12	○	12 = 4,0
30-080-15	○	15 = 5,0

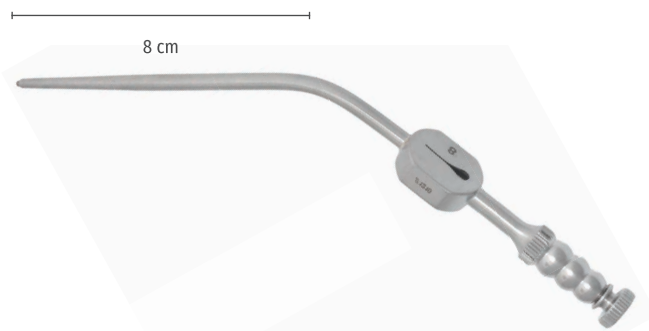

Frazier Saugrohr, konisch, mit tränenförmigem Unterbrecher, 8 cm
Frazier suction tube, conical, with tear shaped suction control, 8 cm

Art.-Nr. Art.-No.		AD / OD Ch/Fr = mm
30-105-06	○	6 = 2,0
30-105-08	○	8 = 2,7
30-105-10	○	10 = 3,3

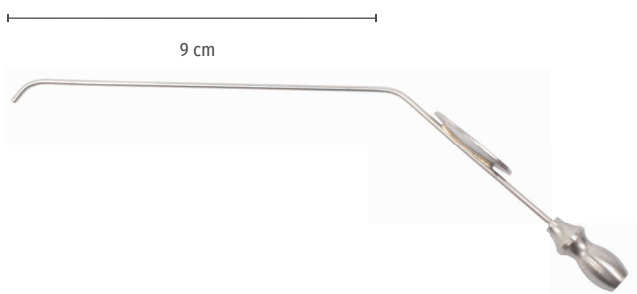

Verhoeven Saugrohr mit Griffplatte, abwärts gebogen, 9 cm
Verhoeven suction tube with finger plate, downwards curved, 9 cm

Art.-Nr./No.		AD / OD
10-314-15	○	1,5
10-313-24	○	2,0



Verhoeven Saugrohr mit Griffplatte, aufgebogen, 9 cm
Verhoeven suction tube with finger plate, upcurved, 9 cm

Art.-Nr./No.		AD / OD
10-314-14	○	1,5
10-313-23	○	2,0



01 Ambulantes Ohr-Instrumentarium

Diagnostic Ear Instruments



Verhoeven Saugrohr mit Griffplatte, 9 cm, gerade
Verhoeven suction tube with finger plate, 9 cm, straight

Art.-Nr./No.		ID / ID (mm)
10-313-12	○	1,2
10-314-13	○	1,5
10-313-20	○	2,0

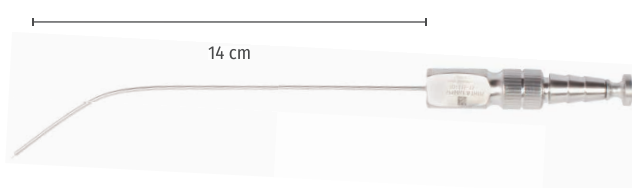

Plester Saugrohr mit Griffplatte und Unterbrecher, 14 cm
Plester suction tube with suction control, 14 cm

Art.-Nr./No.		ID / ID (mm)
10-315-15	○	1,5
10-315-20	○	2,0
10-315-25	○	2,5
10-315-30	○	3,0

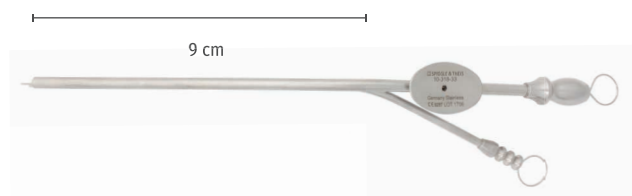

House Saug- und Spülrohr mit Unterbrecher, zylindrisch, 9 cm
House suction and irrigation tube with suction control, cylindrical, 9 cm

Art.-Nr./No.	ID / ID (mm)
10-318-14	1,3 x 1,0
10-318-15	1,6 x 1,4
10-318-23	2,3 x 1,5
10-318-33	3,3 x 2,3
10-318-45	4,0 x 2,5





Langenbeck Raspatorium, Breite 16 mm, 19,5 cm
Langenbeck raspatory, width 16 mm, 19.5 cm

10-348-19



Farabœuf Periost Raspatorium, Breite 13 mm, 15 cm
Farabœuf periost raspatory, width 13 mm, 15 cm

Art.-Nr./No.	Beschreibung / Description
10-350-13	gebogen / curved
10-351-13	gerade / straight

Fisch Raspatorium, Breite 10 mm, 15,5 cm
Fish raspatory, width 10 mm, 15.5 cm

10-347-17



Cottle Raspatorium, gebogen, 20 cm / Cottle raspatory, curved, 20 cm

Art.-Nr./No.	Größe / Size (mm)
10-352-08	8
10-352-14	14



Lempert Raspatorium, 17 cm / Lempert raspatory, 17 cm

Art.-Nr. Art.-No.	Größe Size (mm)	Beschreibung Description
10-353-02	2	leicht gebogen / slightly curved
10-353-03	3	leicht gebogen / slightly curved
10-353-04	4	leicht gebogen / slightly curved
10-353-05	5	leicht gebogen / slightly curved
10-353-07	7	sehr leicht gebogen very slightly curved
10-354-03	3	stark gebogen / strongly curved

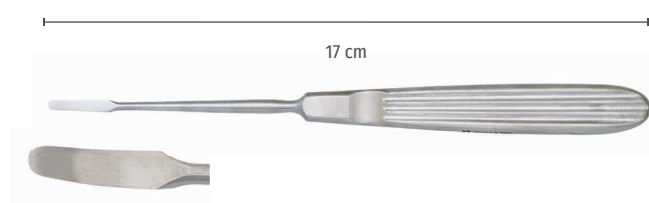

Plester Gehörgangsraspatorium, flach gebogen, 8 mm, 18 cm
Plester raspatory, slightly curved, 8 mm, 18 cm

10-355-08

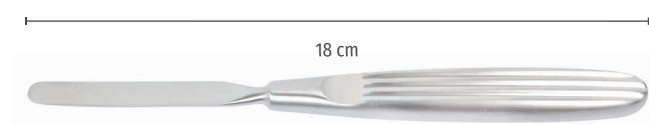

Wullstein Raspatorium, 16,5 cm / Wullstein raspatory, 16.5 cm

Art.-Nr./No.	Größe / Size (mm)
10-356-00	4,0
10-356-01	2,5



02 Antrotomie

Antrotomy

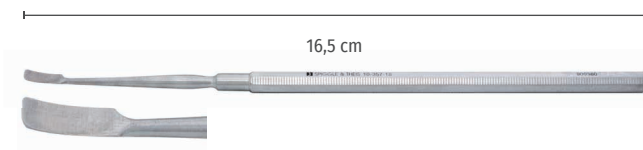

Wullstein Raspatorium, abgerundete Ecken, 4 mm, 16,5 cm
Wullstein raspatory, with rounded edges, 4 mm, 16.5 cm

10-357-18



Shambough-Derlacki Duckbill-Raspatorium, leicht gebogen, 3 mm, 14,5 cm

Shambough-Derlacki duckbill raspatory, slightly curved, 3 mm, 14.5 cm

10-358-15

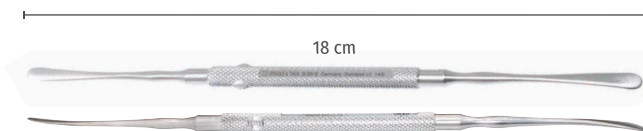

Freer Doppelelevatorium, scharf/stumpf, 18 cm

Freer elevator, double ended, sharp/blunt, 18 cm

20-305-18



Skalpelle-Griff / Scalpel handle

Art.-Nr./No.	Nr. / No.	Länge / Length (cm)
10-360-03	3	12,5
10-360-04	4	13
10-360-07	7	16

Skalpelle-Klingen, einzeln steril verpackt, 100 Stück

Scalpel blades, single sterile packed, 100 pieces

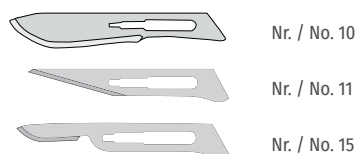

Art.-Nr./No.	Nr. / No.	Beschreibung / Description
10-360-10	10	gerundet / rounded
10-360-11	11	spitz / pointed
10-360-15	15	gerundet / rounded



Trautmann Hohlmeißel, 14 cm / Trautmann gouge, 14 cm

Art.-Nr./No.	Größe / Size (mm)
10-365-02	2
10-365-04	4
10-365-06	6
10-365-08	8



Trautmann Flachmeißel, 14 cm / Trautmann chisel, 14 cm

Art.-Nr./No.	Größe / Size (mm)	
10-366-02	2	┌
10-366-04	4	┌
10-366-06	6	┌
10-366-08	8	┌



Cottle Hammer, 18 cm / Cottle mallet, 18 cm

20-400-18

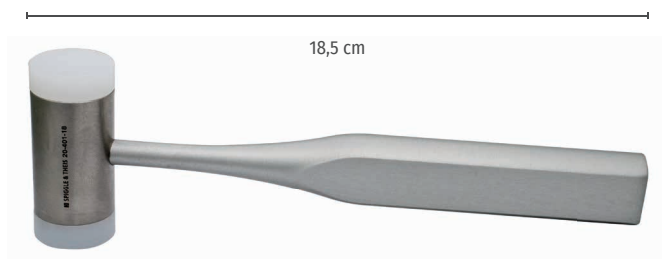

**Metallhammer mit auswechselbaren Nylonbacken, 18,5 cm
Metal mallet with convertible nylon facings, 18.5 cm**

20-401-18



**Nylon-Ersatzbacken für Metallhammer, 25 mm, Paar
Nylon spare facings for metal mallet, 25 mm, pair**

20-401-99

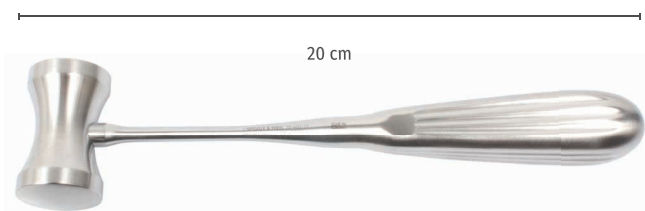

Hajek Metallhammer, 200 g, 20 cm

Hajek metal mallet, 200 g, 20 cm

20-402-21

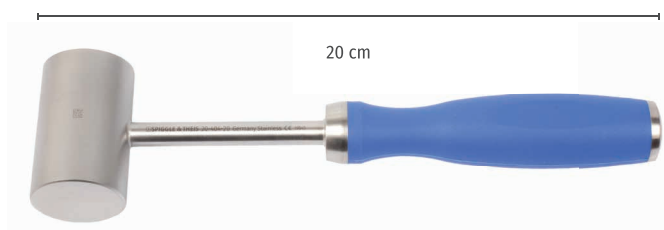

Hammer mit Silikongriff, 20 cm

Mallet with silicone handle, 20 cm

20-404-20



02 Antrotomie

Antrotomy

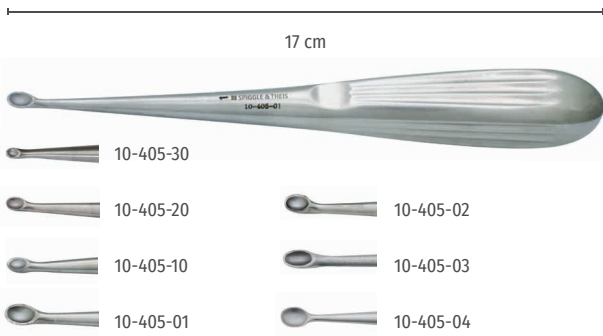

Spratt Mastoid-Löffel, 17 cm / Spratt mastoid curette, 17 cm

Art.-Nr./No.	Größe / Size
10-405-30	000
10-405-20	00
10-405-10	0
10-405-01	1
10-405-02	2
10-405-03	3
10-405-04	4

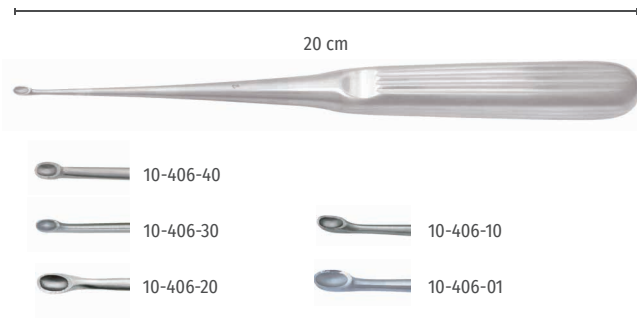

Lempert Mastoid-Löffel, 20 cm / Lempert mastoid curette, 20 cm

Art.-Nr./No.	Größe / Size
10-406-40	0000
10-406-30	000
10-406-20	00
10-406-10	0
10-406-01	1



Luer Knochenzange, gebogen, 15 cm

Luer rongeur, curved, 15 cm

10-408-15

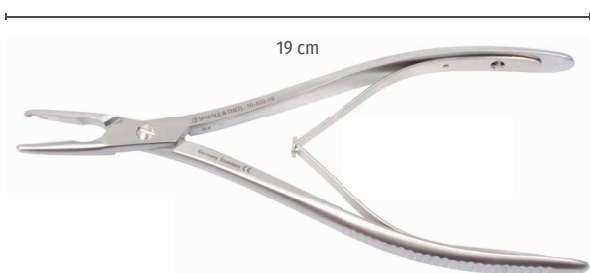

Lempert Knochenzange, 19 cm / Lempert rongeur, 19 cm

Art.-Nr./No.	Beschreibung / Description
10-409-19	gerade / straight
10-410-19	gebogen / curved

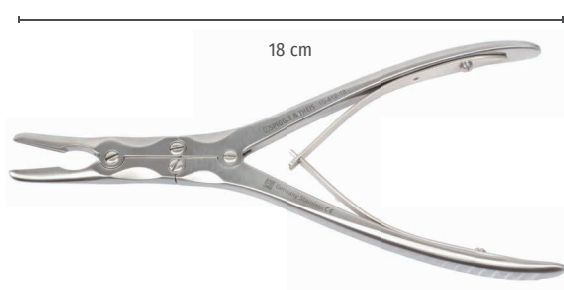

Beyer Knochenzange, gebogen, Doppelgelenk, 18 cm
Beyer rongeur, curved, double joint 18 cm

10-412-18



Citelli Knochenstanze, Größe 2, 2,0 mm, 8,7 cm
Citelli bone punch, size 2, 2.0 mm, 8.7 cm

10-415-02

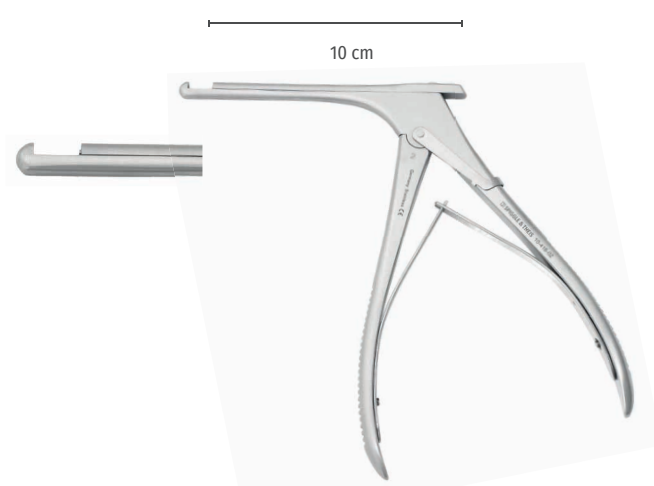

Kerrison Knochenstanze, komplett zerlegbar, 10 cm
Kerrison bone punch, fully detachable, 10 cm

Art.-Nr./No.	Größe / Size
10-416-01	1 (4,0 mm)
10-416-02	2 (4,5 mm)
10-416-03	3 (5,0 mm)



Präzision - Schärfe - Sicherheit

Precision - Sharpness - Safety

Low- and HighSpeed		Osteotomiebohrer, Hartmetall oder Stahl, 70 mm Osteotomy burs, carbide or steel, 70 mm
Low- and HighSpeed		Osteotomiebohrer, Cross-Cut, Hartmetall oder Stahl, 70 mm Osteotomy burs, Cross-Cut, carbide or steel, 70 mm
Low- and HighSpeed		Osteotomiebohrer, A-Verzahnung, Stahl, Hartmetall nur LS, 70 mm Osteotomy burs, A-toothing, steel, carbide LS only, 70 mm
Low- and HighSpeed		Diamantbohrer, mittlere Körnung, 70 mm Diamond burs, medium grain, 70 mm
Low- and HighSpeed		Diamantbohrer, extra grobe Körnung, 70 mm Diamond burs, extra-coarse grain, 70 mm
Low- and HighSpeed		Diamantbohrer, super grobe Körnung, 70 mm Diamond burs, super coarse grain, 70 mm

Bitte beachten Sie, dass es im Bereich der Rotierenden Instrumente eine Vielzahl an Schaftanschliffen, Längen, Kopfformen und anderen Details gibt. Aus diesem Grund ist es nicht möglich, alle Varianten an dieser Stelle abzubilden.

Eine Übersicht über das komplette Produktsortiment erhalten Sie auf **Anfrage unter: +49 (0) 2206 90 81 - 0**

Please notice that there are many standards of shank, length, head form and various other details in the range of rotary instruments. For this reason it is impossible to show all available variations on this page.

For a complete overview of our entire bur assortment **please ask your local distributor.**

Vorteile unserer Rotierenden Instrumente:

- Minimierte Vibrationen
- Weiche Drehbewegungen, die sowohl Bohrer als auch Handstücke schonen
- Effiziente Materialabtragung durch optimal designte Bohrköpfe

Advantages of our rotary instruments:

- Minimum vibration
- Smooth rotary action protects burs and handpieces
- Efficient removal of tissue due to optimized bur head design



Wullstein Wundsperrer, 3:3 Zähne, halbscharf, zerlegbar
Wullstein retractor, 3:3 prongs, semi-sharp, dismountable

Art.-Nr./No.	Länge / Length (cm)
10-420-11	11,0
10-420-13	13,5
10-420-16	16,0

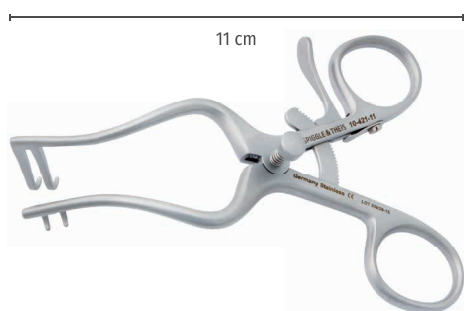

Plester Wundsperrer, 2:2 Zähne, halbscharf, extra fein, 11 cm, zerlegbar
Plester retractor, 2:2 prongs, semi-sharp, extra fine, 11 cm, dismountable

10-421-11



Plester Wundsperrer, 2:2 Zähne, halbscharf, zerlegbar
Plester retractor, 2:2 prongs, semi-sharp, dismountable

Art.-Nr./No.	Länge / Length (cm)
10-422-11	11,0
10-422-13	13,5

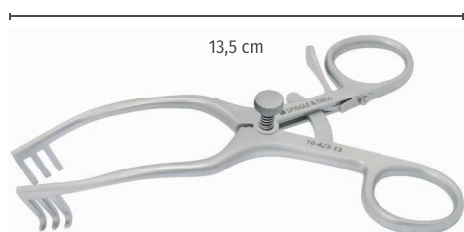

Schuknecht-Fisch Wundsperrer, gewinkelt, 3:3 Zähne, halbscharf, 13,5 cm, zerlegbar
Schuknecht-Fisch retractor, angled, 3:3 prongs, semi-sharp, 13.5 cm, dismountable

10-423-13

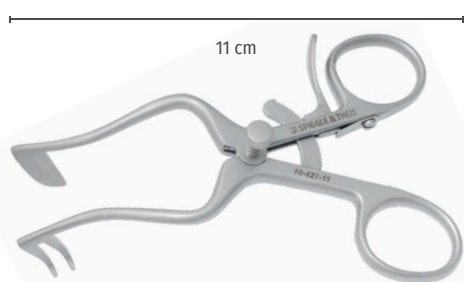

Plester Wundsperrer, 11 cm, zerlegbar
Plester retractor, 11 cm, dismountable

Art.-Nr./No.	Beschreibung / Description
10-426-11	2 Zähne rechts, Blatt links 2 prongs right, blade left
10-427-11	2 Zähne links, Blatt rechts 2 prongs left, blade right



04 Wundsperrer

Retractors

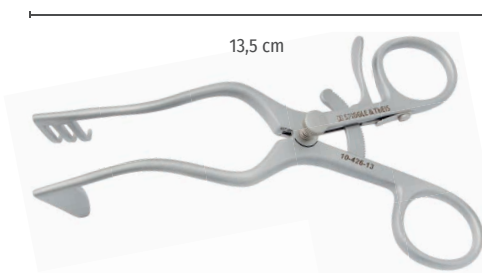

Plester Wundsperrer, 3 Zähne rechts, Blatt links, 13,5 cm, zerlegbar
Plester retractor, 3 prongs right, blade left, 13.5 cm, dismountable

10-426-13

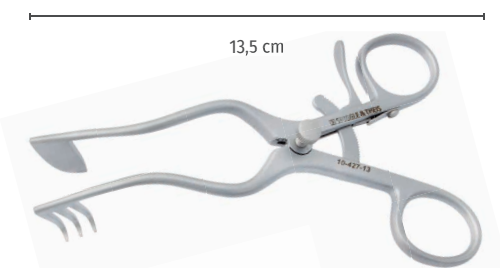

Plester Wundsperrer, 3 Zähne links, Blatt rechts, 13,5 cm, zerlegbar
Plester retractor, 3 prongs left, blade right, 13.5 cm, dismountable

10-427-13

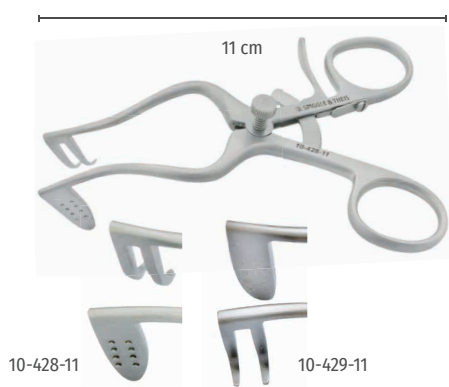

Helms Wundsperrer, 11 cm, zerlegbar
Helms retractor, 11 cm, dismountable

Art.-Nr./No.	Beschreibung / Description
10-428-11	2 Zähne rechts, Blatt mit Noppen links 2 prongs right, studded blade left
10-429-11	2 Zähne links, Blatt mit Noppen rechts 2 prongs left, studded blade right

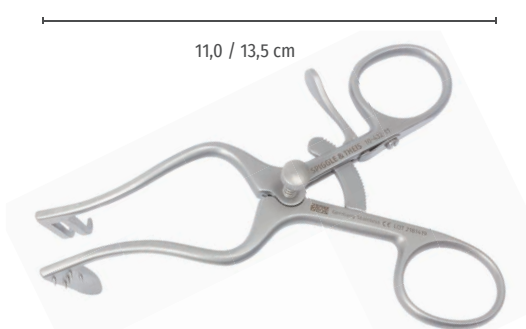

Perkins Wundsperrer, 2 Zähne rechts, gezahntes Blatt links, zerlegbar
Perkins retractor, 2 prongs right, pointed blade left, dismountable

Art.-Nr./No.	Länge / Length (cm)
10-432-11	11,0
10-432-13	13,5

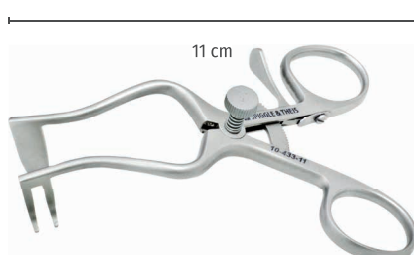

Perkins Wundsperrer, 2 Zähne links, gezahntes Blatt rechts, 11 cm, zerlegbar
Perkins retractor, 2 prongs left, pointed blade right, 11 cm, dismountable

10-433-11



Perkins Wundsperrer, 3 Zähne links, gezahntes Blatt rechts, 13,5 cm, zerlegbar
Perkins retractor, 3 prongs left, pointed blade right, 13.5 cm, dismountable

10-433-13

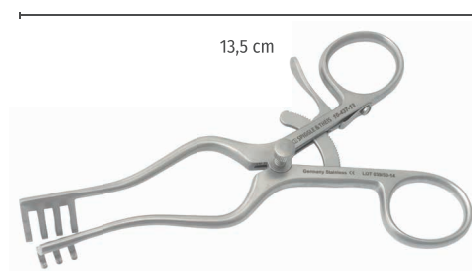

Weitlaner Wundsperrer, 3:4 Zähne, stumpf, zerlegbar, gerade, 13,5 cm
Weitlaner retractor, 3:4 prongs, blunt, dismountable, straight, 13.5 cm

10-437-13

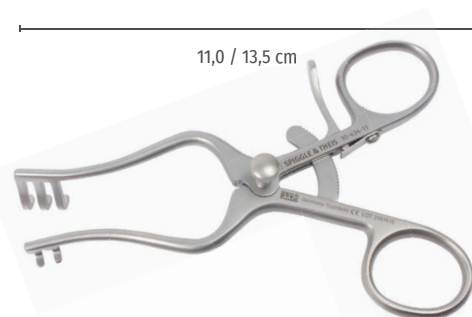

Weitlaner Wundsperrer, 2:3 Zähne, stumpf, zerlegbar
Weitlaner retractor, 2:3 prongs, blunt, dismountable

Art.-Nr./No.	Länge / Length (cm)
10-434-11	11,0
10-434-13	13,5

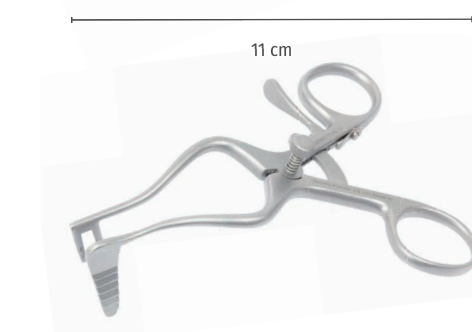

Wigand endauraler Wundsperrer, 11 cm, zerlegbar
Wigand endaural retractor, 11 cm, dismountable

Art.-Nr./No.	Beschreibung / Description
10-430-11	2 Zähne rechts, geriefte Platte links 2 prongs right, serrated plate left
10-431-11	2 Zähne links, geriefte Platte rechts 2 prongs left, serrated plate right

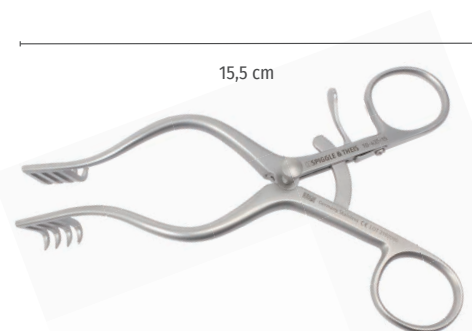

Mollison Wundsperrer, 4:4 Zähne, 15,5 cm, zerlegbar
Mollison retractor, 4:4 prongs, 15.5 cm, dismountable

10-435-15



04 Wundsperrer

Retractors



**Fisch Wundsperrer mit Gelenken,
3:3 Zähne, halbscharf, 16,5 cm, zerlegbar**
Fisch retractor, with joint, 3:3 prongs, semi-sharp,
16.5 cm, dismountable

10-438-17

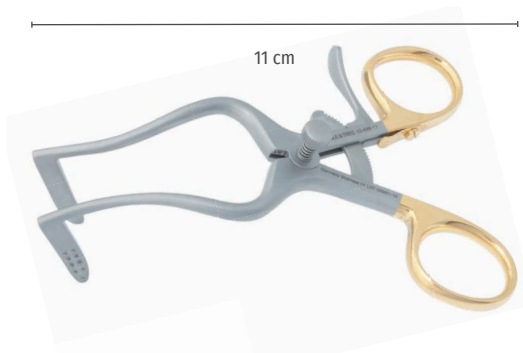

**Preyer Wundsperrer, schmales Blatt, Griff vergoldet,
beidseits mit Noppen, 11 cm, zerlegbar**
Preyer retractor, slim blade, gold plated grip,
studded on both sides, 11 cm, dismountable

10-446-11

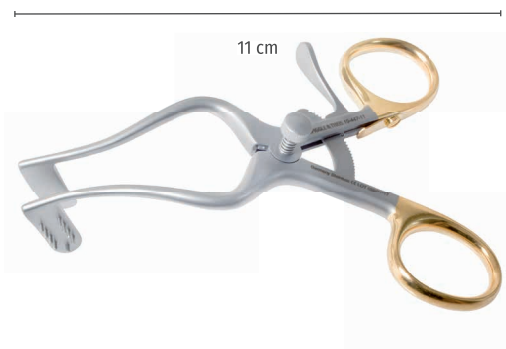

**Dazert Wundsperrer, beidseits mit langen Noppen,
Griff vergoldet, zerlegbar, 11 cm**
Dazert retractor, long studs on both sides,
gold plated grip, dismountable, 11 cm

10-447-11

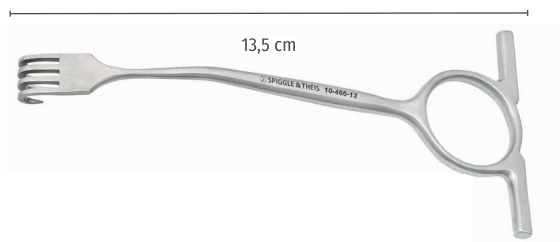

Williger Wundhaken, 4 scharfe Zähne, 13,5 cm
Williger retractor, 4 sharp prongs, 13.5 cm

10-466-13



Williger Wundhaken, 3 scharfe Zähne, 13,5 cm
Williger retractor, 3 sharp prongs, 13.5 cm

10-467-13

05 Pinzetten

Dressing Forceps

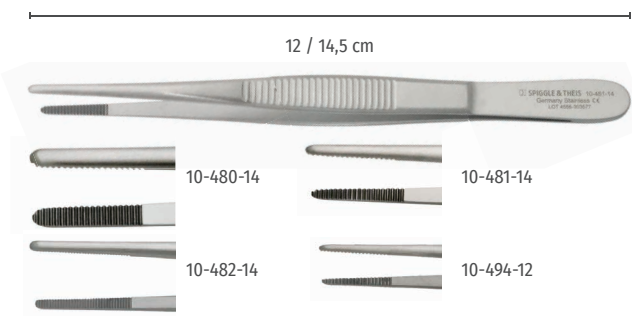

Pinzette, anatomisch, gerade

Dressing forceps, anatomical, straight

Art.-Nr./No.	Spitze / Tip (mm)	Länge / Length (cm)
10-480-14	3,5	14,5
10-481-14	2,0	14,5
10-482-14	1,7	14,5
10-494-12	1,3	12,0

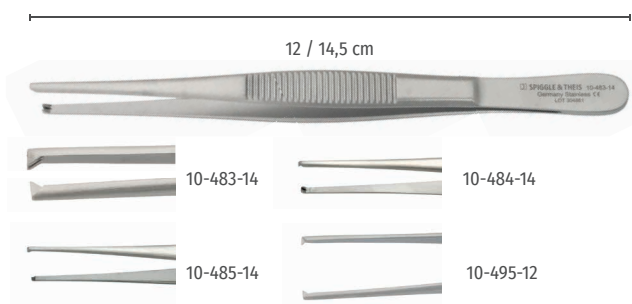

Pinzette, chirurgisch, 1:2 Zähne, gerade

Dressing forceps, 1:2 teeth, straight

Art.-Nr./No.	Spitze / Tip (mm)	Länge / Length (cm)
10-483-14	2,3	14,5
10-484-14	1,7	14,5
10-485-14	1,4	14,5
10-495-12	1,5	12,0



McIndoe Pinzette, anatomisch, gerade, 2 mm, 15 cm

McIndoe dressing forceps, anatomical, straight, 2 mm, 15 cm

10-485-15

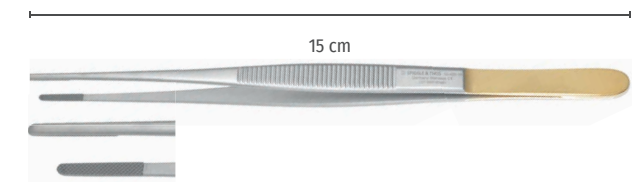

Pinzette, Hartmetall, anatomisch, gerade, 1,5 mm, 15 cm

Dressing forceps, tungsten carbide, anatomical, straight, 1,5 mm, 15 cm

10-488-15

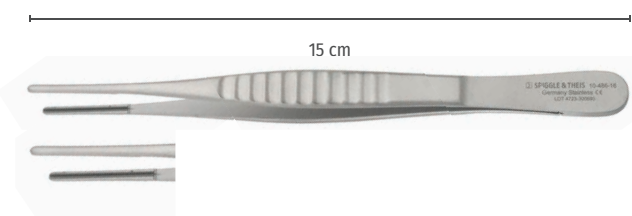

DeBakey Pinzette, atraumatisch, gerade, 15 cm

DeBakey dressing forceps, atraumatic, straight, 15 cm

Art.-Nr./No.	Spitze / Tip (mm)
10-486-16	2,0
10-487-16	1,5

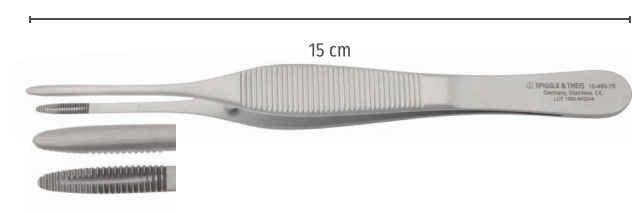

Helms Pinzette, anatomisch, gerade, 2,8 mm, 15 cm

Helms dressing forceps, anatomical, straight, 2,8 mm, 15 cm

10-489-15



05 Pinzetten

Dressing Forceps

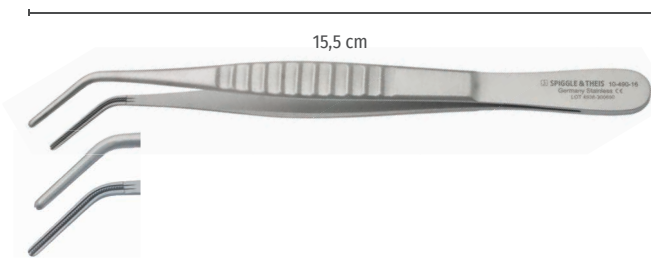

DeBakey Pinzette, atraumatisch, gewinkelt, 15,5 cm
DeBakey dressing forceps, atraumatic, angled, 15.5 cm

Art.-Nr./No. Spitze / Tip (mm)

10-490-16	2,0
-----------	-----

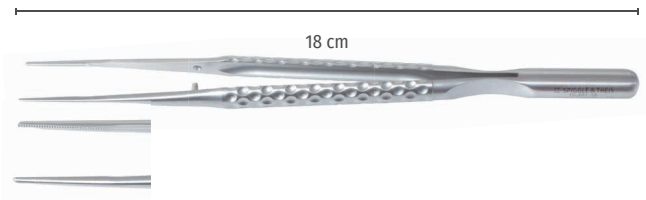

Atrauma-Mikro-Pinzette, mit Gewicht, gerade, Führungsstift, Golfball-Design, 1,2 mm, 18 cm
Atrauma micro forceps, with counterweight & guide pin, straight, golfball-design, 1.2 mm, 18 cm

10-491-18

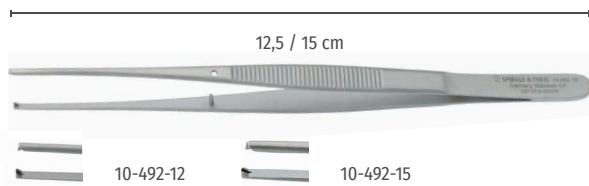

Semken Pinzette, fein, 1:2 Zähne
Semken dressing forceps, fine, 1:2 teeth

Art.-Nr./No.

Länge / Length (cm)

10-492-12	12,5
10-492-15	15,0

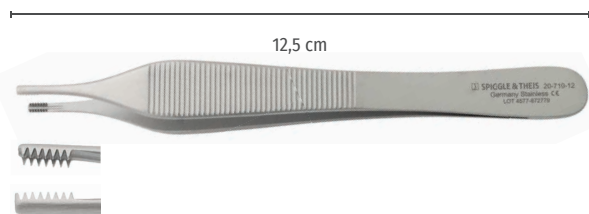

Adson-Brown Pinzette, 7:8 Zähne, 12,5 cm
Adson-Brown forceps, 7:8 teeth, 12.5 cm

20-710-12

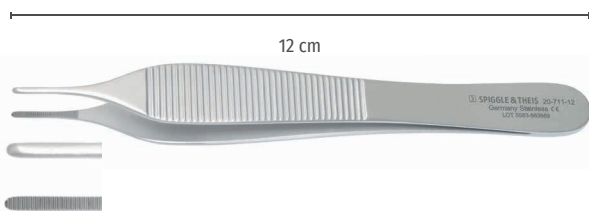

Adson Pinzette, anatomisch, 12 cm
Adson dressing forceps, anatomical, 12 cm

20-711-12

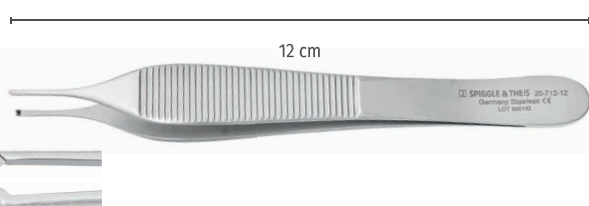

Adson Pinzette, chirurgisch, 1:2 Zähne, 12 cm
Adson dressing forceps, 1:2 teeth, 12 cm

20-712-12

05 Pinzetten

Dressing Forceps

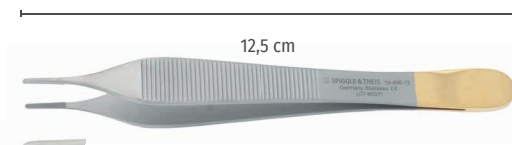

Adson Pinzette, Hartmetall, anatomisch, 12,5 cm

Adson dressing forceps, tungsten carbide, anatomical, 12.5 cm

10-496-12



Derlacki Gehörknöchelchen-Pinzette, 7:8 Zähne, 12,5 cm

Derlacki ossicle holding forceps, 7:8 teeth, 12.5 cm

10-497-12



Wullstein Pinzette, gerade, 1 mm, 15,5 cm

Wullstein dressing forceps, straight, 1 mm, 15.5 cm

Art.-Nr./No.	Beschreibung / Description
10-498-15	anatomisch / anatomical
10-499-15	chirurgisch / 1:2 teeth

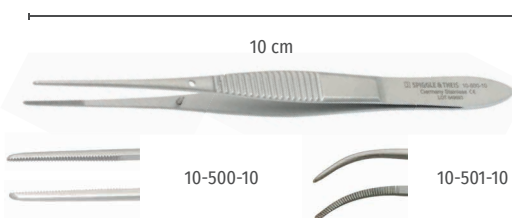

Graefe Pinzette, anatomisch, 0,7 mm, 10 cm

Graefe dressing forceps, anatomical, 0.7 mm, 10 cm

Art.-Nr./No.	Beschreibung / Description
10-500-10	gerade / straight
10-501-10	gebogen / curved

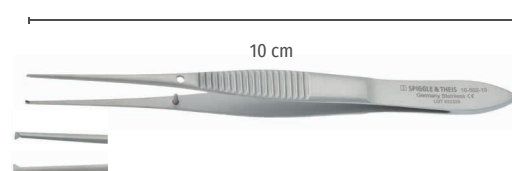

Graefe Pinzette, chirurgisch, 1:2 Zähne, gerade, 0,7 mm, 10 cm

Graefe dressing forceps, 1:2 teeth, straight, 0.7 mm, 10 cm

10-502-10

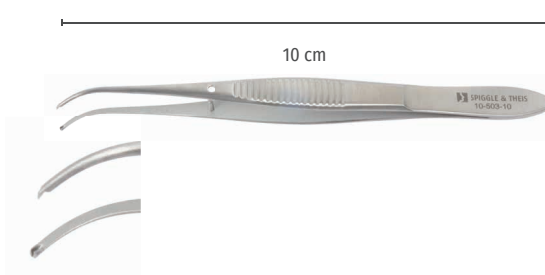

Graefe Pinzette, chirurgisch, 1:2 Zähne, gebogen, 0,7 mm, 10 cm

Graefe dressing forceps, 1:2 teeth, curved, 0.7 mm, 10 cm

10-503-10



05 Ring-Pinzetten

Ring Forceps



Dr. med. Rainer Zimmermann
Leitender Oberarzt der Universitäts-
HNO-Klinik Tübingen

Dr. Rainer Zimmermann M.D.,
Senior consultant at the ENT clinic,
University of Tübingen, Germany

Operative Zugänge zum inneren Gehörgang, insbesondere auch zur Akustikusneurinom-Chirurgie, sind meist sehr klein. Häufig vermisst der HNO-Chirurg ein geeignetes Instrument, um zum Beispiel beim Fundus des inneren Gehörganges um die "Ecke" greifen zu können. Hierzu eignen sich Ringpinzetten mit verschiedenen Winkeln und verschiedenen Größen, sowohl mit als auch ohne Koagulationsmöglichkeit. In der Praxis haben sich die neu konstruierten Pinzetten hervorragend bewährt.

Operative access to the inner ear, particularly during acoustic neurinoma surgery is often very small. It would be helpful for the surgeon if, when working in the inner ear canal, he had an instrument with which he can reach around corners. Ring forceps meet this need. They are available in various angles and sizes, as well as with and without coagulation facilities. In practice, the newly constructed ring forceps have proved themselves to be an excellent solution.

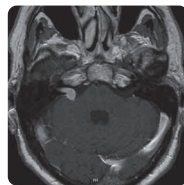

Intra-extrameatales AN links
(Grad II)

Intra-extrameatal
AN left (2nd degree)

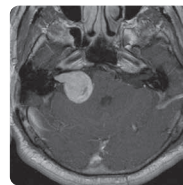

Intra-extrameatales AN rechts
(Grad IV-V)

Intra-extrameatal
AN right (4th - 5th degree)

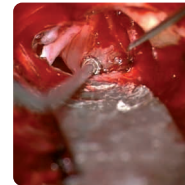

Transtemporale AN-Operation
links

Transtemporal
AN surgery left

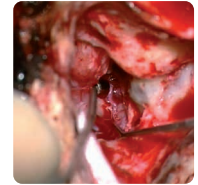

Translabrynthäre AN-Operation
rechts

Translabrynthine
AN surgery right



sehr fein, 16 cm / very fine, 16 cm

Art.-Nr./No.	AD / OD (mm)
80-201-01	1,0
80-201-02	2,0
80-201-03	3,0



Zimmermann Akustikusneurinom, sehr fein, 16 cm

Zimmermann Acoustic neurinoma, very fine, 16 cm

Art.-Nr./No.	Winkel / Angle	AD / OD (mm)
80-202-01	70°-80° aufwärts 70°-80° upwards	1,0
80-202-02	45° aufwärts 45° upwards	2,0



Zimmermann Akustikusneurinom,

80° aufwärts, AD 2 mm, ID 1 mm, 17 cm

Zimmermann Acoustic neurinoma,

80° upwards, OD 2 mm, ID 1 mm, 17 cm

80-204-01

05 Pinzetten

Dressing Forceps

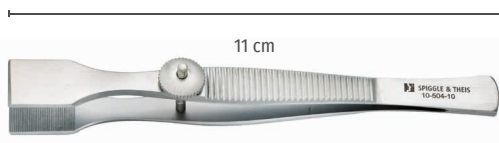

Hildmann Knorpelpinzette, gerade, 11 cm
Hildmann cartilage forceps, straight, 11 cm

10-504-10



Pinzette nach Bishop-Harmon, 1 : 2 Zähne, Länge 8,5 cm
Forceps by Bishop-Harmon, 1 : 2 teeth, length 8.5 cm

Art.-Nr./No.	Spitze / Tip (mm)
10-506-05	0,5
10-506-10	1,0

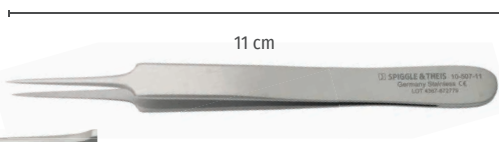

Uhrmacherpinzette, spitz, 11 cm
Jeweller forceps, pointed, 11 cm

10-507-11



Uhrmacherpinzette, spitz, 14,5 cm
Jeweller forceps, pointed, 14.5 cm

10-507-14

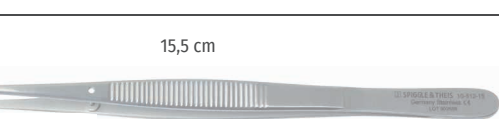

Einführpinzette, gewinkelt, Längsnut, 15,5 cm
Insertion forceps, angled, longitudinal groove, 15.5 cm

10-512-15



06 Scheren
Scissors

Linkshänder Scheren
auf Anfrage
Left handed scissors
on request



Schere, gerade, spitz-spitz
Scissors, straight, pointed

Art.-Nr./No.	Länge / Length (cm)	Beschreibung / Description
10-530-10	10,5	sehr fein / very fine
10-530-12	11,5	

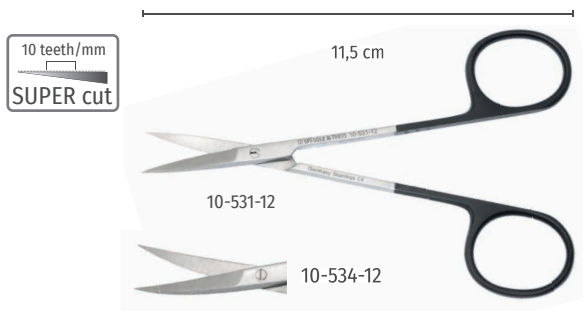

Schere, supercut, spitz-spitz, sehr fein, 11,5 cm
Scissors, supercut, pointed, very delicate, 11.5 cm

Art.-Nr./No.	Beschreibung / Description
10-531-12	gerade / straight
10-534-12	gebogen / curved

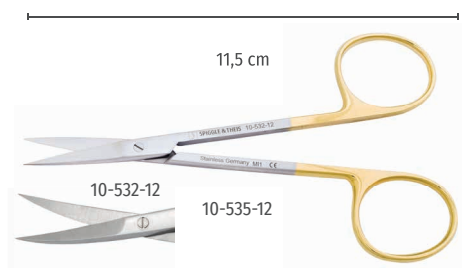

Schere, Hartmetall, spitz-spitz, 11,5 cm
Scissors, tungsten carbide, pointed, 11.5 cm

Art.-Nr./No.	Beschreibung / Description
10-532-12	gerade / straight
10-535-12	gebogen / curved



Schere, gebogen, spitz-spitz, extra fein, 10,5 cm
Scissors, curved, pointed, very fine, 10.5 cm
10-536-10



Schere, gebogen, spitz-spitz, fein
Scissors, curved, pointed, delicate

Art.-Nr./No.	Länge / Length (cm)
10-533-10	10,5
10-533-12	11,5



Joseph Schere, spitz-spitz, 14,5 cm
Joseph scissors, pointed, 14.5 cm

Art.-Nr./No.	Beschreibung / Description
20-600-14	gerade / straight
20-601-14	gebogen / curved



Joseph Schere, Hartmetall, spitz-spitz, 14 cm
Joseph scissors, tungsten carbide, pointed, 14 cm

Art.-Nr./No.	Beschreibung / Description
20-602-14	gerade / straight
20-603-14	gebogen / curved

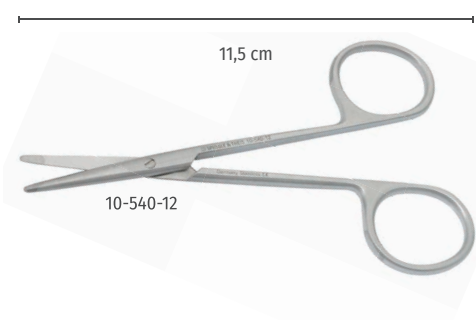

Schere, stumpf-stumpf, 11,5 cm
Scissors, blunt, 11.5 cm

Art.-Nr./No.	Beschreibung / Description
10-540-12	gerade / straight
10-543-12	gebogen / curved

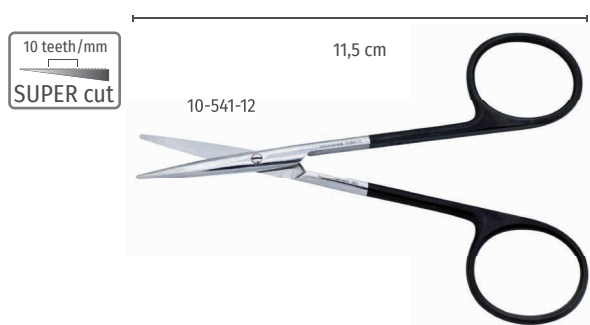

Schere, supercut, stumpf-stumpf, 11,5 cm
Scissors, supercut, blunt, 11.5 cm

Art.-Nr./No.	Beschreibung / Description
10-541-12	gerade / straight
10-544-12	gebogen / curved



06 Scheren

Scissors



Schere, Hartmetall, gerade, stumpf-stumpf, 11,5 cm
Scissors, tungsten carbide, straight, blunt, 11.5 cm

10-542-12



Schere, Hartmetall, gebogen, stumpf-stumpf, 11,5 cm
Scissors, tungsten carbide, curved, blunt, 11.5 cm

10-545-12

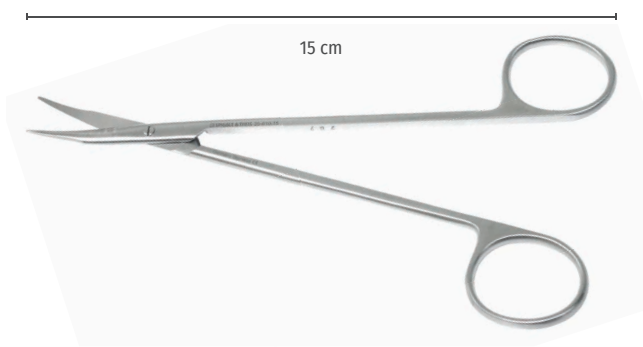

Reynolds Schere, stumpf-stumpf, gebogen, verjüngte Spitzen, 15 cm
Reynolds scissors, blunt, curved, tapered tips, 15 cm

20-610-15



Metzenbaum Schere, stumpf-stumpf, 14,5 cm
Metzenbaum scissors, blunt, 14.5 cm

Art.-Nr./No.	Beschreibung / Description
20-612-14	gebogen / curved
20-612-15	gerade / straight
20-614-15	gebogen, fein / curved, fine



Metzenbaum Schere, Hartmetall, stumpf-stumpf, 14,5 cm
Metzenbaum scissors, tungsten carbide, blunt, 14.5 cm

Art.-Nr./No.	Beschreibung / Description
20-613-15	gerade / straight
20-615-15	gebogen / curved

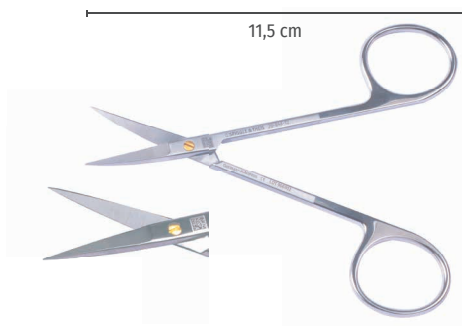

Schere, spitz-spitz, Premium Line, 11,5 cm
Scissor, pointed, Premium Line, 11,5 cm

Art.-Nr./No.	Beschreibung / Description
20-647-12	gerade, straight
20-648-12	gebogen, curved

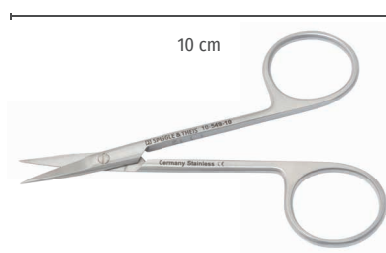

Schuknecht Drahtschneidescherchen, gezahnt, gerade, 10 cm
Schuknecht wire cutting scissors, serrated, straight, 10 cm

10-549-10



Universalschere, gebogen, spitz-stumpf, 13 cm
Universal scissors, curved, pointed-blunt, 13 cm

10-550-13



Cooper Schere, gebogen, spitz-stumpf, 14,5 cm
Cooper scissors, curved, pointed-blunt, 14.5 cm

80-448-15

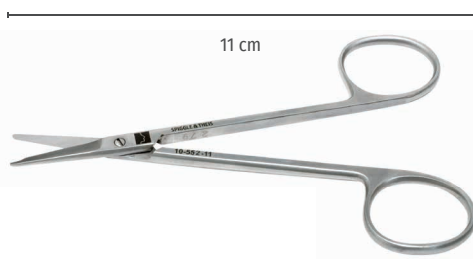

Spencer Drahtschneideschere, 11 cm
Spencer wire cutting scissors, 11 cm

10-552-11



Halsey Nadelhalter, Hartmetall, fein, 13 cm
Halsey needle holder, tungsten carbide, delicate, 13 cm

Art.-Nr./No.	Beschreibung / Description
10-555-13	
10-556-13	ohne Sperre / without ratchet



07 Mikrochirurgische Instrumente

Microsurgery Instruments

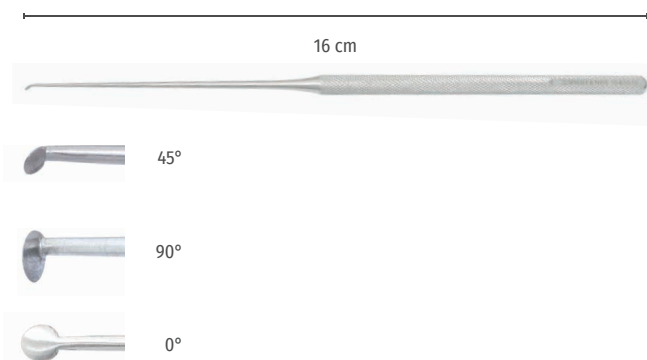

Rosen Rundschneidmesser, 16 cm / Rosen round knife, 16 cm

Art.-Nr./No.	Größe / Size (mm)	Winkel / Angle
10-610-10	1,0	45°
10-610-12	1,2	45°
10-610-15	1,5	45°
10-610-18	1,8	45°
10-610-20	2,0	45°
10-610-23	2,3	45°
10-610-25	2,5	45°
10-610-30	3,0	45°
10-611-06	0,6	90°
10-611-10	1,0	90°
10-611-15	1,5	90°
10-611-20	2,0	90°
10-611-25	2,5	90°
10-612-10	1,0	0°
10-612-15	1,5	0°
10-612-20	2,0	0°
10-612-25	2,5	0°
10-612-30	3,0	0°

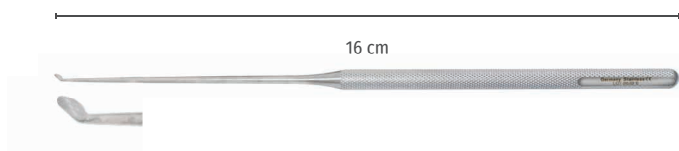

Rosen Raspatorium, oval, 45°, 16 cm

Rosen raspatory, oval, 45°, 16 cm

10-613-00

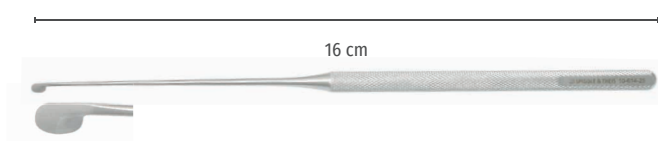

Plester Rundschneidmesser, vertikal, oval, 3,5 x 2,5 mm, 16 cm

Plester flap knife, vertical, oval, 3,5 x 2,5 mm, 16 cm

10-614-25

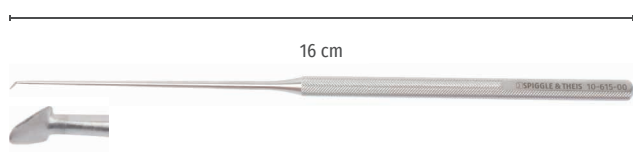

Rosen Lanzettmesser, dreieckig, 45°, 16 cm

Rosen lancet knife, triangular, 45°, 16 cm

10-615-00

07 Mikrochirurgische Instrumente

Microsurgery Instruments

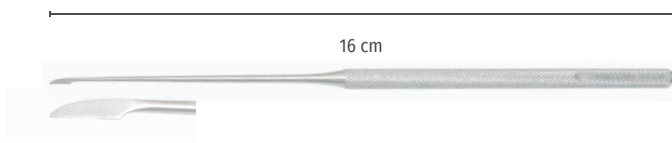

Plester Sichelmesser, gerade, fein, 16 cm
Plester sickle knife, straight, delicate, 16 cm

10-616-00

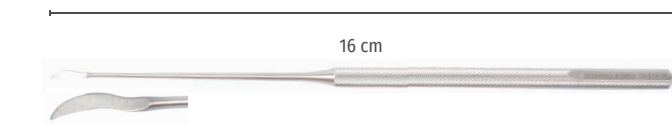

Fisch Tenotom, 16 cm
Fisch sickle knife, 16 cm

10-619-00

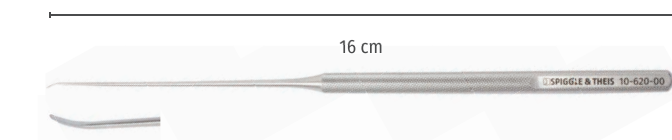

Stapesgelenk-Messer, 2,2 mm, 20°, 16 cm
Incudostapedial joint knife, 2.2 mm, 20°, 16 cm

10-620-00

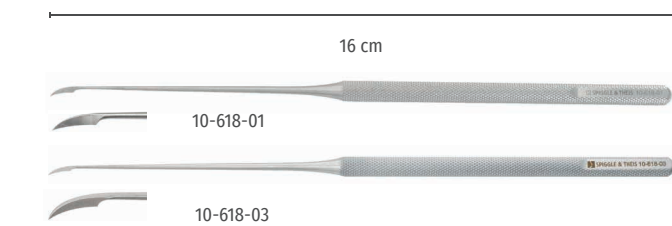

Wullstein Sichelmesser, fein, 16 cm
Wullstein sickle knife, delicate, 16 cm

Art.-Nr./No.	Beschreibung / Description
10-618-01	leicht gebogen / slightly curved
10-618-03	stark gebogen / strongly curved

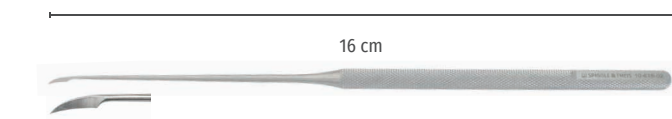

Wullstein Sichelmesser, leicht gebogen, sehr fein, 16 cm
Wullstein sickle knife, very delicate, slightly curved, 16 cm

10-618-02

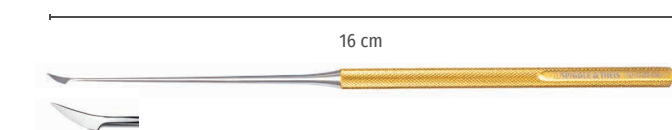

Teschner Sichelmesser, leicht gebogen, Schneide konvex, 16 cm
Teschner sickle knife, slightly curved, convex blade, 16 cm

10-618-04

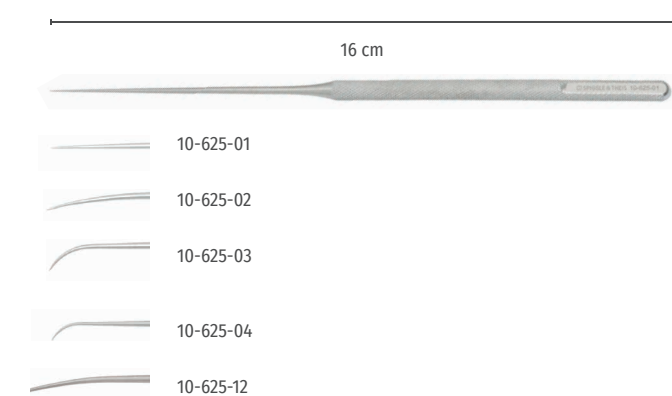

Wullstein Mikronadel, 16 cm / Wullstein micro needle, 16 cm

Art.-Nr./No.	Beschreibung / Description
10-625-01	gerade, spitz / straight, pointed
10-625-02	sehr leicht gebogen, spitz / very slightly curved, pointed
10-625-03	stark gebogen, spitz / strongly curved, pointed
10-625-04	leicht gebogen, spitz / slightly curved, pointed
10-625-12	sehr leicht gebogen, stumpf / very slightly curved, blunt



07 Mikrochirurgische Instrumente

Microsurgery Instruments

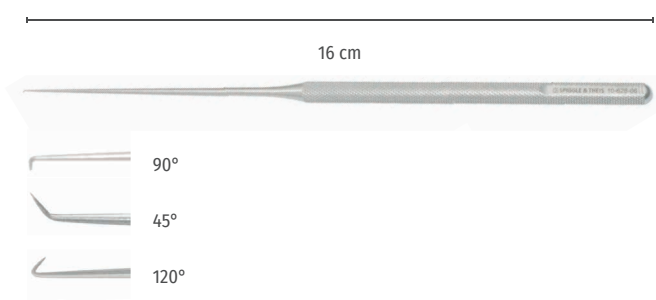

Wullstein Mikrohäkchen, 16 cm / Wullstein micro hook, 16 cm

Art.-Nr. Art.-No.	Hakenlänge Length of hook (mm)	Winkel Angle
10-628-02	0,2	90°
10-628-04	0,4	90°
10-628-05	0,5	90°
10-628-06	0,6	90°
10-628-08	0,8	90°
10-628-10	1,0	90°
10-628-12	1,2	90°
10-628-15	1,5	90°
10-628-20	2,0	90°
10-628-25	2,5	90°
10-628-30	3,0	90°
10-628-40	4,0	90°
10-630-02	0,2	45°
10-630-04	0,4	45°
10-630-06	0,6	45°
10-630-08	0,8	45°
10-630-10	1,0	45°
10-630-12	1,2	45°
10-630-15	1,5	45°
10-630-20	2,0	45°
10-630-25	2,5	45°
10-631-18	1,8	120°

Wullstein Mikrohäkchen "Colour Line", 16 cm

Wullstein Microhook "Colour Line", 16 cm

Die Verwendung von Etiketten oder Aufklebern zur Kennzeichnung von Instrumenten gilt inzwischen als überholt. Beschriftungsverlust, Klebereste und Hygienerisiken gehören mit der "Colour Line" von SPIGGLE & THEIS der Vergangenheit an. Die Farbcodierung bei unserer Wullstein Mikrohäkchen "Colour Line"-Serie ermöglicht eine schnelle und sichere Identifizierung von Winkel und Länge.

The use of labels or stickers for marking instruments is now considered obsolete. Caption loss, adhesive residue and hygiene risks are now no more inevitable concomitants of the unique instrument identification.

The colour coding of SPIGGLE & THEIS leads to a rapid and reliable identification of angle and length of the Wullstein microhooks from the "Colour Line" series.

Vorteile:

- Biokompatibel
- Autoklavierbar
- Hohe Haft-, Stoß- und Abriebbeständigkeit
- Kein Verblassen durch gängige Desinfektionsverfahren oder maschinelle Reinigungsmethoden

Advantages:

- Biocompatible
- Autoclavable
- Non-conductive
- No fading by continuous disinfection process or mechanical cleaning methods



Schnelle Identifizierung von Winkel und Länge des Häkchens:

Fast identification of angle and length of the hook:

Farbcodierung grün / Colour coding green = 45°

Farbcodierung rot / Colour coding red = 90°

Längenidentifizierung pro Ring / Length per ring = 0,2 mm

Art.-Nr. Art.-No.	Ringe Rings	Hakenlänge Length of hook (mm)	Winkel Angle
10-626-02	1 roter / red	0,2	90°
10-626-04	2 rote / red	0,4	90°
10-626-06	3 rote / red	0,6	90°
10-626-08	4 rote / red	0,8	90°
10-626-10	5 rote / red	1,0	90°
10-627-02	1 grüner / green	0,2	45°
10-627-04	2 grüne / green	0,4	45°
10-627-06	3 grüne / green	0,6	45°
10-627-08	4 grüne / green	0,8	45°
10-627-10	5 grüne / green	1,0	45°



07 Mikrochirurgische Instrumente

Microsurgery Instruments



Prof. Dr. Marco Caversaccio
Chefarzt, Inselspital, HNO-Klinik
der Universität-Bern

Prof. Dr. Marco Caversaccio
Department of ORL, Head and Neck Surgery,
University Inselspital Bern, Switzerland

Die Ausmessung der Perforationsgröße einer Trommelfellperforation ist essentiell. Durch drei verschiedene Größen kann das Gewebe optimal zurechtgeschnitten und zur Deckung der Trommelfellperforation eingesetzt werden. In der Praxis haben sich die verschiedenen Tympanosizer sehr bewährt und zu einer qualitativen Verbesserung des zurechtzuschneidenden Gewebes geführt, was auch zu einer Operationszeitreduktion geführt hat.

The measurement of the perforation size of an eardrum perforation is essential. By three different sizes, the tissue can be optimally trimmed and used to cover the eardrum perforation. In practice, the various tympanosizers have proven to be very useful and lead to a qualitative improvement in the tissue to be cut, which has also led to an operation time reduction.

**Caversaccio Tympano Sizer,
kniegebogen, geschwärzt**
**Caversaccio Tympano Sizer,
shaft angled, black coated**



Art.-Nr./No.	Größe / Size (mm)
10-609-02 TAN	2,0
10-609-04 TAN	4,0
10-609-06 TAN	6,0



07 Mikrochirurgische Instrumente

Microsurgery Instruments

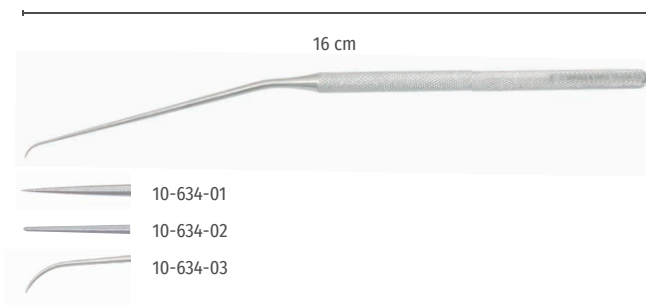

Schuknecht Mikronadel, Schaft gewinkelt, Nadel gerade, 16 cm Schuknecht micro needle, shaft angled, straight needle, 16 cm

Art.-Nr./No.	Beschreibung / Description
10-634-01	scharf / sharp
10-634-02	stumpf / blunt
10-634-03	stark abwärts gebogen strongly curved downwards

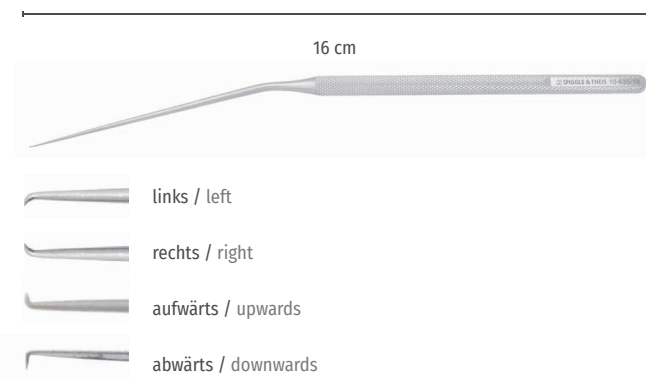

Schuknecht Mikrohäkchen, Schaft kniegebogen, 16 cm Schuknecht micro hook, angled shaft, 16 cm

Art.-Nr. Art.-No.	Hakenlänge Length of hook (mm)	Winkel Angle
10-635-02	0,2	90° aufwärts / upwards
10-635-04	0,4	90° aufwärts / upwards
10-635-06	0,6	90° aufwärts / upwards
10-635-08	0,8	90° aufwärts / upwards
10-635-10	1,0	90° aufwärts / upwards
10-635-12	0,2	90° links / left
10-635-14	0,4	90° links / left
10-635-16	0,6	90° links / left
10-635-18	0,8	90° links / left
10-635-22	0,2	90° rechts / right
10-635-24	0,4	90° rechts / right
10-635-26	0,6	90° rechts / right
10-635-28	0,8	90° rechts / right
10-636-02	0,2	90° abwärts / downwards
10-636-04	0,4	90° abwärts / downwards
10-636-06	0,6	90° abwärts / downwards
10-636-08	0,8	90° abwärts / downwards
10-636-10	1,0	90° abwärts / downwards



07 Mikrochirurgische Instrumente

Microsurgery Instruments

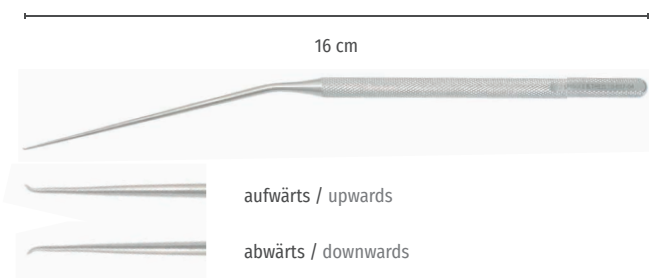

Schuknecht Mikrohäkchen, Schaft gewinkelt, 16 cm
Schuknecht micro hook, angled shaft , 16 cm

Art.-Nr. Art.-No.	Hakenlänge Length of hook (mm)	Winkel Angle
10-637-02	0,2	45° aufwärts / upwards
10-637-04	0,4	45° aufwärts / upwards
10-637-06	0,6	45° aufwärts / upwards
10-637-08	0,8	45° aufwärts / upwards
10-637-10	1,0	45° aufwärts / upwards
10-637-62	0,2	45° rechts / right
10-638-02	0,2	45° abwärts / downwards
10-638-04	0,4	45° abwärts / downwards
10-638-06	0,6	45° abwärts / downwards
10-638-08	0,8	45° abwärts / downwards
10-638-10	1,0	45° abwärts / downwards

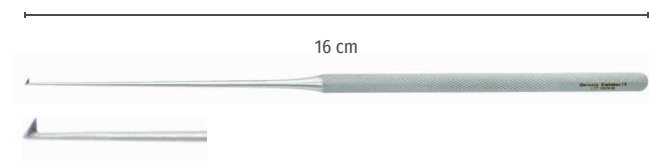

**Plester Häkchen retrograd,
2 mm, zum Anrauen des Trommelfells, 16 cm**
**Plester hook, retrograde, 2 mm,
to abrade the tympanic membrane, 16 cm**

10-640-00

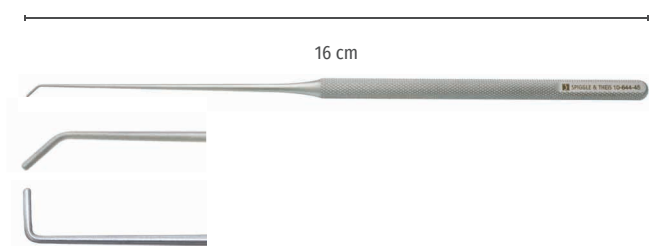

Plester Antrumhäkchen, 4 mm, stumpfes Ende, 16 cm
Plester antrum hook, 4 mm, blunt tip, 16 cm

Art.-Nr./No.	Winkel / Angle
10-644-45	45°
10-644-90	90°

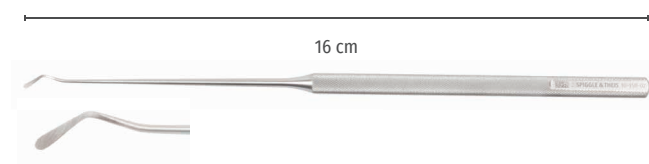

Austin Dissektor, 16 cm / Austin dissector, 16 cm

Art.-Nr./No.	Winkel / Angle
10-158-01	rechts gebogen / right curved
10-158-02	links gebogen / left curved

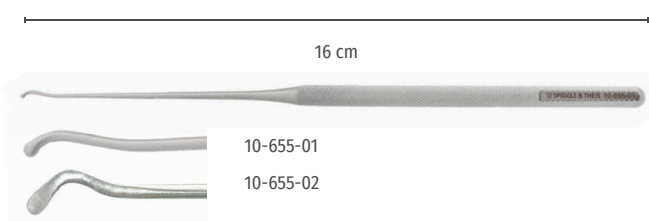

Fisch Dissektor, doppelt gebogen, 16 cm
Fisch dissector, double curved, 16 cm

Art.-Nr./No.	Winkel / Angle
10-655-01	rechts / right
10-655-02	links / left

07 Mikrochirurgische Instrumente

Microsurgery Instruments

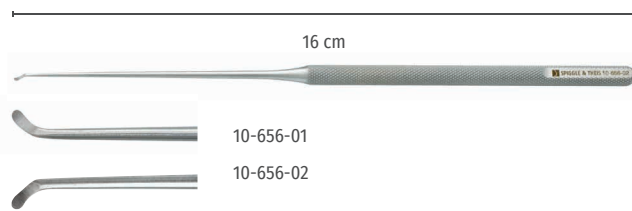

Fisch Dissektor, einfach gebogen, 16 cm

Fisch dissector, single curved, 16 cm

Art.-Nr./No.	Winkel / Angle
10-656-01	rechts / right
10-656-02	links / left

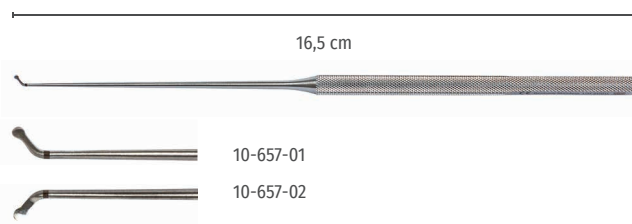

Preyer Dissektor, Sinus Tympani, zirkuläre Markierung, 3 mm, 16,5 cm

Preyer dissector, sinus tympani, circular marking, 3 mm, 16,5 cm

Art.-Nr./No.	Winkel / Angle
10-657-01	rechts gebogen / right curved
10-657-02	links gebogen / left curved

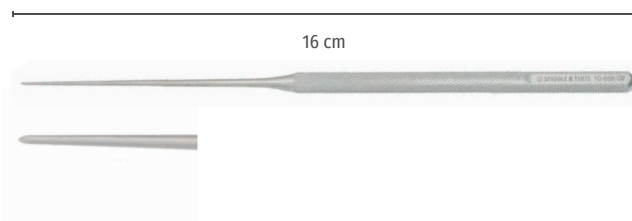

Fisch Fußplatten-Perforator, 16 cm

Fisch footplate perforator, 16 cm

Art.-Nr./No.	AD / OD (mm)
10-658-03	0,3
10-658-04	0,4
10-658-05	0,5
10-658-06	0,6
10-658-08	0,8

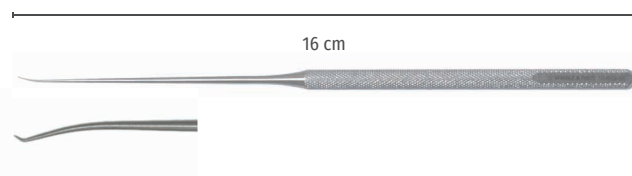

Zenner Fußplattenhäkchen, 90°, 0,6 mm, gebogener Schaft, 16 cm

Zenner footplate hook, 90°, 0.6 mm, curved shaft, 16 cm

10-632-00

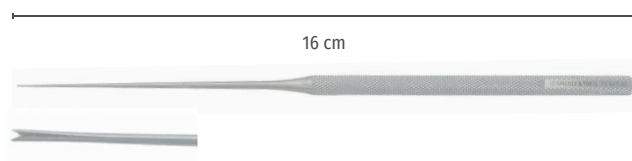

Plester Einführungsgabel für Stapes-Prothesen, 16 cm

Plester guiding fork for stapes prostheses, 16 cm

10-647-00

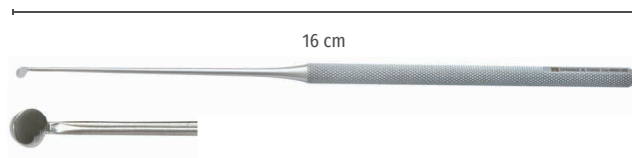

Paukenspiegel, 3 mm, 16 cm

Atticus mirror, 3 mm, 16 cm

10-662-30

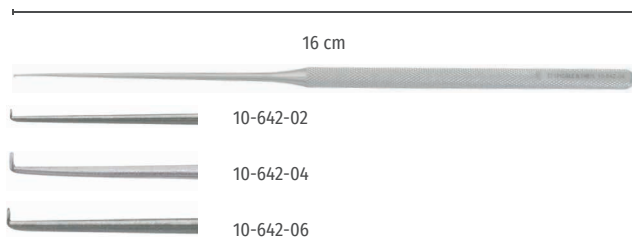

Plester Fußplattenhäkchen, 16 cm

Plester footplate hook, 16 cm

Art.-Nr./No.	Hakenlänge / Length of hook (mm)
10-642-02	0,2
10-642-04	0,4
10-642-06	0,6



07 Mikrochirurgische Instrumente

Microsurgery Instruments

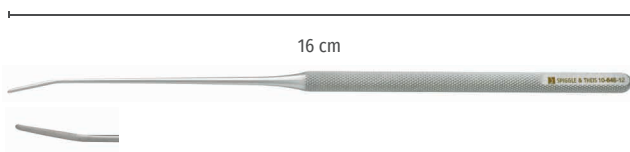

Rosen Raspatorium, 1 x 12 mm, 16 cm
Rosen raspatory, 1 x 12 mm, 16 cm

10-648-12

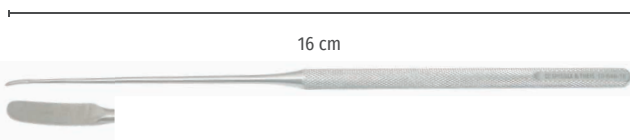

Beales Elevatorium, 1,5 x 5,5 mm, 16 cm
Beales elevator, 1.5 x 5.5 mm, 16 cm

10-649-18

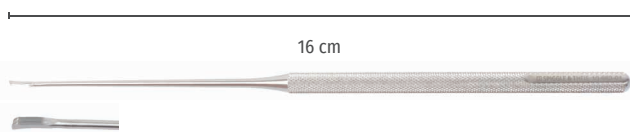

Mikro-Ritz-Instrument zur Anthelix-Plastik, leicht gebogen, 1,5 x 5 mm, 3 konkave Schneiden, 16 cm
Micro scratching instrument for anthelixplasty, slightly curved, 1.5 x 5 mm, 3 concave blades, 16 cm

10-663-01

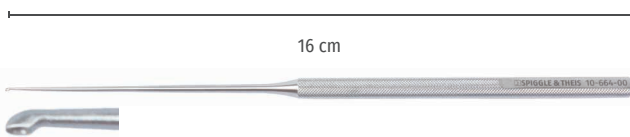

Mikrolöffel für Cochleostomie, oval, gerade, Schaft gerade, 0,8 x 1,2 mm, 16 cm
Curette for cochleostomy, oval cup, straight, straight shaft, 0.8 x 1.2 mm, 16 cm

10-664-00

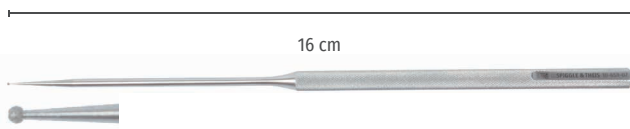

Handbohrer, Diamant, fein, 0,7 mm, 16 cm
Hand burr, diamond, fine, 0.7 mm, 16 cm

10-659-07

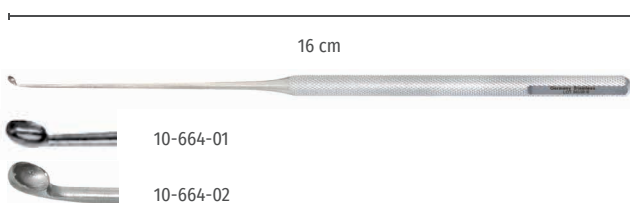

Mikrolöffel, oval, 1,5 x 2,5 mm, 16 cm
Curette, oval cup, 1.5 x 2.5 mm, 16 cm

Art.-Nr./No.	Schaft / Shaft	Winkel / Angle
10-664-01	gerade / straight	gerade / straight
10-664-02	gerade / straight	45°
10-664-03	gewinkelt / angled	gerade / straight
10-664-04	gewinkelt / angled	45°

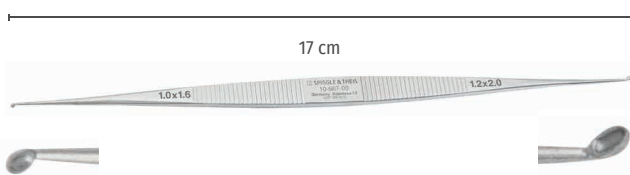

House Doppellöffel, leicht gebogen, 17 cm
House curette, double ended, slightly curved, 17 cm

Art.-Nr./No.	Größe / Size (mm)
10-667-00	1,0 x 1,6 / 1,2 x 2,0 (Gr. / Sz. 0)
10-667-01	1,5 x 2,5 / 1,8 x 2,8 (Gr. / Sz. 1)
10-667-02	2,2 x 3,0 / 2,5 x 3,2 (Gr. / Sz. 2)
10-667-03	2,6 x 3,2 / 2,8 x 3,5 (Gr. / Sz. 3)

07 Mikrochirurgische Instrumente

Microsurgery Instruments



Prof. Dr. med. Serena Preyer
Chefärztin der HNO-Klinik des
Diakonissenkrankenhauses Karlsruhe

Prof. Dr. med. Serena Preyer
Chief physician of the ENT Clinic
Diakonissenkrankenhauses,
Karlsruhe, Germany

Der durchschnittliche Durchmesser des Incus beträgt 0,7 mm, der genaue Durchmesser kann jedoch von Patient zu Patient variieren. Aus diesem Grund wurde in Zusammenarbeit mit Prof. Serena Preyer eine Incusgabel mit 0,7 mm Durchmesser entwickelt, um die richtige Größe von Stapes-Prothesen zu ermitteln. Die Größe des Hakens wird bestimmt, indem einfach die Incusgabel über den Incus gelegt wird.

The average diameter of the incus is 0.7 mm, but the exact diameter can vary from patient to patient. For this reason an incus fork with 0.7 mm diameter was developed in collaboration with Prof. Serena Preyer, to ascertain the proper size of stapes prostheses. The size of the hook is determined by simply placing the incus fork over the incus.

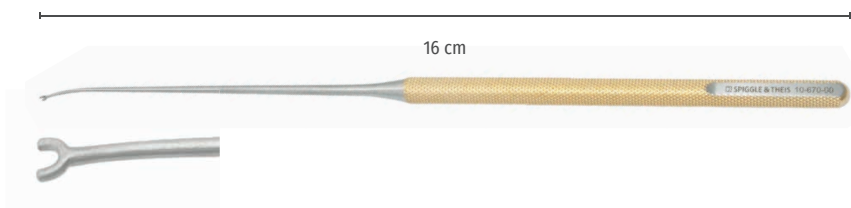

Preyer Ambossgabel

Preyer incus fork

10-670-00

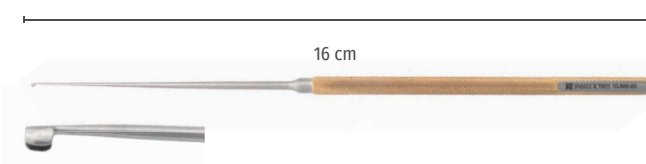

Müller Einführungsinstrument für Cochlea Implantate, gerade, vergoldeter Griff, 16 cm

Müller insertion fork for cochlea implants,
straight, gold plated handle, 16 cm

10-660-00



Tisch Mikrolöffel / Tisch micro curette

Art.-Nr./No.	Größe / Size (mm)	Winkel / Angle
10-665-00	universal	Handgriff / handle
10-665-01	(1) 1,5 x 2,3	gerade / straight
10-665-02	(2) 2,0 x 3,5	gerade / straight
10-665-03	(3) 3,0 x 5,0	gerade / straight
10-665-04	(1) 1,5 x 2,3	15° gewinkelt / angled
10-665-05	(2) 2,0 x 3,5	15° gewinkelt / angled
10-665-06	(3) 3,0 x 5,0	15° gewinkelt / angled



07a Titan Instrumente nach Prof. Wollenberg

Prof. Wollenberg Titanium Instruments



Prof. Dr. med. B. Wollenberg
Direktorin der Klinik und Poliklinik für Hals-, Nasen- und Ohrenheilkunde, Lehrstuhl für Hals-, Nasen- und Ohrenheilkunde der Technischen Universität München (TUM)

Prof. Dr. med. B. Wollenberg
Director of the clinic and polyclinic for ear, nose and throat medicine, Chair of Otorhinolaryngology at the Technical University Munich (TUM), Germany

Die Implantation der Vibrant Soundbridge (VSB) hat sich in der Therapie der sensorineuralen und der kombinierten Schwerhörigkeiten in z.B. voroperierten Ohren oder bei komplexeren Missbildungen des Mittelohres bewährt. Die Ankopplung der VSB an die vorhandenen anatomischen Strukturen kann durch den Einsatz nicht magnetischer Titan Instrumente erheblich erleichtert werden. Mithilfe der vorgestellten Instrumente, die frequent bei solchen Operationen zum Einsatz kommen, kann die VSB leicht positioniert werden und wird nicht mehr versehentlich von magnetischer Geisterhand bewegt.

Vibrant Soundbridge (VSB) implantation is well established in the surgical treatment of sensorineural as well as combined hearing loss in eg revision middle ear surgery or complex atresia cases. Coupling the VSB to existing anatomical structures can be greatly facilitated using non magnetic Titanium instruments. With the help of the presented instruments frequently used during such operations, the VSB can be easily positioned and will no longer be displaced by a magnetic ghost hand.

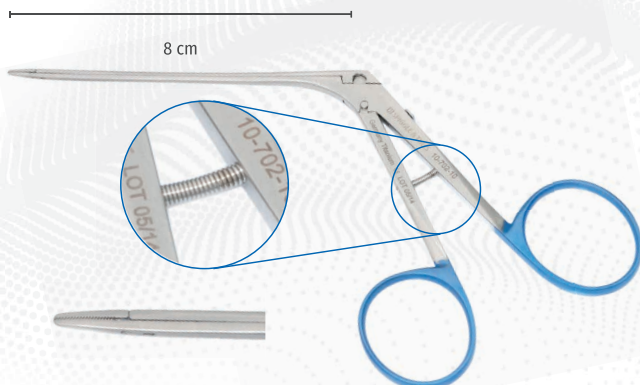

Hartmann Ohrzängchen, Titan, blau, gerieft, gerade, fein, selbstschließend, 8 cm

Hartmann ear forceps, titanium, blue, serrated, straight, delicate, self closing, 8 cm

Art.-Nr./No.	Größe / Size (mm)
10-702-10	1,0 x 6,0
10-702-11	1,0 x 6,0

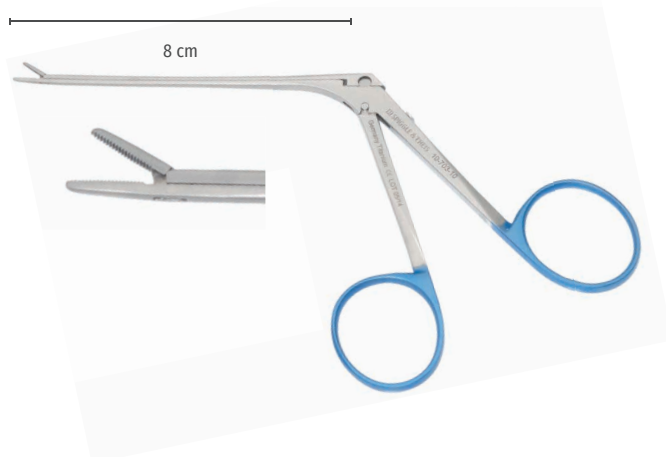

Hartmann Ohrzängchen, Titan, blau, gerieft, gerade, fein, 1,0 x 6,0 mm, 8 cm

Hartmann ear forceps, titanium, blue, serrated, straight, fine, 1.0 x 6.0 mm, 8 cm

10-703-10

07a Titan Instrumente nach Prof. Wollenberg

Prof. Wollenberg Titanium Instruments

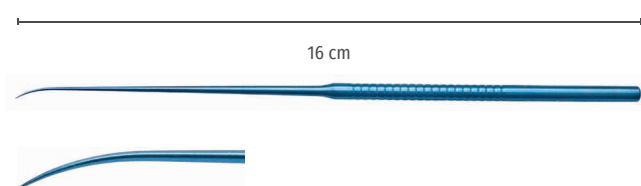

Mikro-Nadel, Titan, blau, nicht magnetisch, 16 cm
Micro needle, titanium, blue, non-magnetic, 16 cm

Art.-Nr./No.	Beschreibung / Description
10-600-00	kurze Biegung, leicht gebogen short curve, slightly curved
10-601-00	lange Biegung, sehr leicht gebogen long curve, very slightly curved

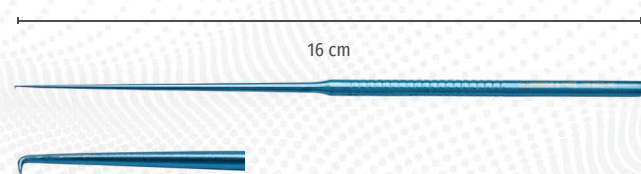

Mikro-Häkchen, Titan, blau, scharf, nicht magnetisch, 1 mm, 16 cm
Micro hook, titanium, blue, sharp, non-magnetic, 1 mm, 16 cm

Art.-Nr./No.	Winkel / Angle
10-603-10	90°
10-604-10	45°

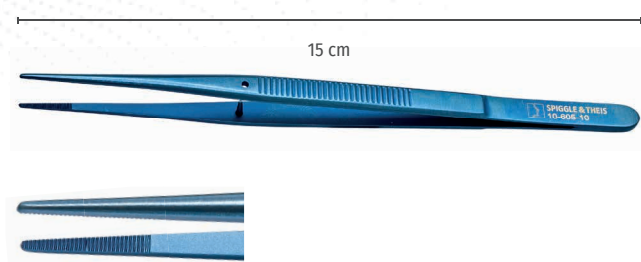

Mikro-Pinzette, Titan, blau, anatomisch, nicht magnetisch, 1 mm, 15 cm
Micro forceps, titanium, blue, anatomical, non-magnetic, 1 mm, 15 cm

10-605-10





Prof. Giuseppe Panetti,
Neapel/Naples, Italy

» Die Saugfunktion ermöglicht gleichzeitiges Schneiden und Absaugen mit nur einem Instrument, wodurch die Effizienz deutlich erhöht wird. «

Jedes Instrument besitzt einen Saugkanal mit Sogsteuerung im Handstück. Die Arbeitsteile der Instrumente entsprechen in Form und Funktion denen klassischer Schneidinstrumente für die Mittelohrchirurgie. Die Saugfunktion ermöglicht gleichzeitiges Schneiden und Absaugen

mit nur einem Instrument. Durch die Saugfunktion des Instruments wird die Effizienz spürbar erhöht. Das Beschlagen der Optik wird deutlich verringert, Gewebeablagerungen an der Endoskopspitze können leicht mit Kochsalzlösung entfernt werden.

Vorteile der Endoskopischen/Mikroskopischen Instrumente Prof. Panetti:

- Zeitsparend
- Weniger traumatisch für den Patienten
- Vereinfacht das Entfernen versteckter Cholesteatome
- Präparieren und Schneiden bei gleichzeitiger, integrierter Absaugung
- Effektive Sogsteuerung
- Autoklavierbar



Advantages of the Endoscopic/Microscopic Instruments Prof. Panetti:

- Time saving
- Less traumatic for the patient
- Enables easier removal of residual cholesteatoma
- Dissection and preparation with concurrent suction
- Effective suction control
- Autoclavable















»» *The suction function enables simultaneous suction and dissection with just one instrument for which efficiency is significantly increased* ««

Combined suction and dissection makes a more sufficient and precise working process. Each instrument has a suction duct with suction control on the handpiece; despite being newly developed the tips of the instruments are the tried and tested forms classically used in middle ear dis-

section. The suction function enables simultaneous suction and dissection. Dissection is more effective when supported by the suction facility. Any otoendoscopic fogging or blood stains around the tip of the endoscope can be easily removed by rinsing with a hydro-saline solution.

07b Endoskopische/Mikroskopische Instrumente nach Prof. Panetti

Endoscopic/Microscopic Instruments by Prof. Panetti

		Saug-Dissektor für Trommelfell, einfach gebogen, 3 mm, 13 cm, Luer-Lock Suction dissector for ear drum, single curved, 3 mm, 13 cm, Luer-Lock	
10-800-12			
10-801-12		Art.-Nr./No.	Richtung / Direction
		10-800-12	links / left
		10-801-12	rechts / right
		Saug-Dissektor für Sinus Tympani, doppelt gebogen, 6 mm, 13 cm, Luer-Lock Suction dissector for sinus tympani, double curved, 6 mm, 13 cm, Luer-Lock	
10-802-12			
10-803-12		Art.-Nr./No.	Richtung / Direction
		10-802-12	rückwärts links / backward left
		10-803-12	rückwärts rechts / backward right
		Saug-Dissektor für Attik, doppelt gebogen, 6 mm, 13 cm, Luer-Lock Suction dissector for atticus, double curved, 6 mm, 13 cm, Luer-Lock	
10-804-12			
10-805-12		Art.-Nr./No.	Richtung / Direction
		10-804-12	vorwärts links / forward left
		10-805-12	vorwärts rechts / forward right
		Saug-Mikrohäkchen, 45°, 13 cm, Luer-Lock Suction micro hook, 45°, 13 cm, Luer-Lock	
10-806-12			
10-867-12		Art.-Nr./No.	Haken / Hook (mm)
10-807-12		10-806-12	1,0
		10-867-12	1,5
		10-807-12	2,0
		Saug-Rundschneidmesser, 45°, 13 cm, Luer-Lock Suction separator, 45°, 13 cm, Luer-Lock	
10-808-12		Art.-Nr. Art.-No.	Größe Size (mm)
10-809-12		10-808-12	2,5
10-811-12		10-809-12	2,0
		10-811-12	2,5
			Beschreibung Description
			Saugöffnung innen suction inner side
			Saugöffnung außen suction outer side
			Saugöffnung außen suction outer side

Saug-Messer, oval, 13 cm, Luer-Lock

Suction knife, oval, 13 cm, Luer-Lock

10-810-12



Art.-Nr./No. Beschreibung / Description

10-810-12 seitliche Öffnung links / lateral opening left

10-812-12



10-812-12 seitliche Öffnung rechts / lateral opening right

Saug-Dissektor für Trommelfell,

einfach gebogen, sehr fein, 13 cm, Luer-Lock

Suction dissector for ear drum, single curved, very delicate, 13 cm, Luer-Lock

10-813-12



Art.-Nr./No. Beschreibung / Description

10-813-12 seitliche Öffnung links / lateral opening left side

10-814-12



10-814-12 seitliche Öffnung rechts / lateral opening right side

Saug-Sichelmesser, gebogen, 13 cm, Luer-Lock

Suction sickle knife, curved, 13 cm, Luer-Lock

10-815-12

Saug-Kürette, gebogen, 13 cm, Luer-Lock

Suction curette, curved, 13 cm, Luer-Lock

10-816-12

Saug-Dissektor, stumpf, 13 cm, Luer-Lock

Suction dissector, blunt, 13 cm, Luer-Lock

10-817-12



Art.-Nr./No. Beschreibung / Description

10-817-12 links aufgebogen / upcurved left

10-818-12



10-818-12 rechts aufgebogen / upcurved right

Preyer Saug-Finder, stumpf, 13 cm, Luer-Lock

Preyer Suction finder, blunt, 13 cm, Luer-Lock

10-819-12

Saxby-Spülinstrument, ovale Spülöffnung, 13 cm, Luer-Lock

Saxby-Irrigator, oval irrigation, 13 cm, Luer-Lock

10-820-12

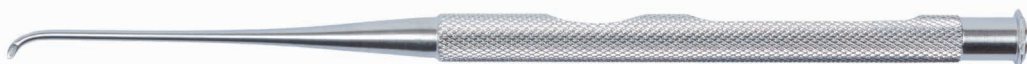

Maßstab / scale 1:1 (13 cm Länge / length)



07b Endoskopische/Mikroskopische Instrumente nach Prof. Panetti

Endoscopic/Microscopic Instruments by Prof. Panetti

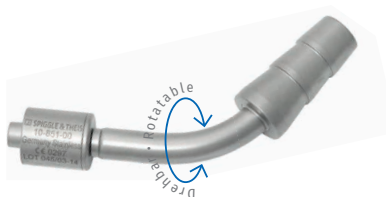

**Saugadapter, drehbar, 55° gebogen,
Luer-Lock männlich, Schlauchansatz**
Suction adapter, rotatable, 55° curved,
luer-lock male, hose connector

10-851-00



**Hochleistungs-Fiberglas-Lichtleitkabel,
Ø 3,5 mm, 90° abgewinkelt, autoklavierbar**
High definition fibre light cable,
Ø 3.5 mm, 90° angled, autoclavable

Art.-Nr./No.	Länge / Length (mm)
70-266-02	1800
70-267-03	3000

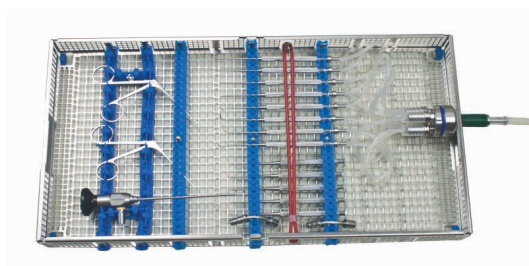

System-Siebkorb für Panetti-Instrumentarium
System Screen Basket for Panetti Instruments

Art.-Nr./No.	Beschreibung / Description
10-840-01	
10-841-01	klein / small



Spülkomponente für System-Siebkorb für Panetti-Instrumentarium
Irrigation component for System Screen Basket
for Panetti Instruments

10-845-01

07b Endoskopische/Mikroskopische Instrumente nach Prof. Panetti

Endoscopic/Microscopic Instruments by Prof. Panetti

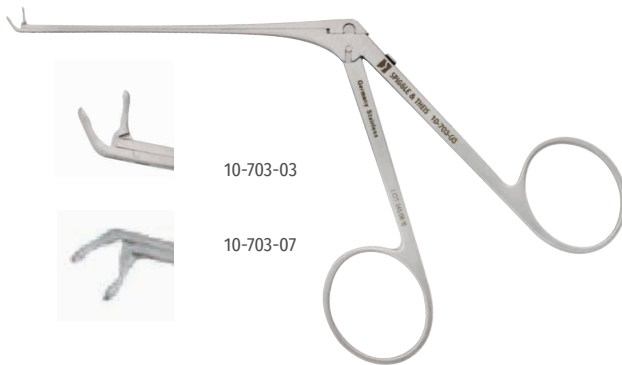

Mikro-Ohrzängchen, ovale Löffel, fein, 0,8 x 1,3 mm, 8 cm
Micro ear forceps, oval cups, fine, 0.8 x 1.3 mm, 8 cm

Art.-Nr./No.	Beschreibung / Description
10-703-03	aufwärts gebogen / curved upwards
10-703-07	abwärts gebogen / curved downwards

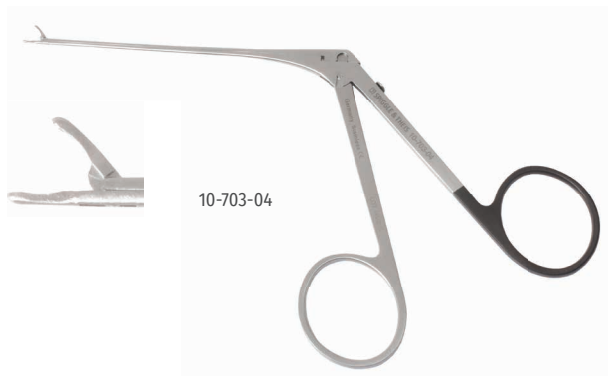

Mikro-Ohrzängchen, ovale Löffel, gerade, extrafein, 0,5 x 1,0 mm, 8 cm
Micro ear forceps, oval cups, straight, extrafine, 0.5 x 1.0 mm, 8 cm

10-703-04



Saug-Sichelmesser für Akustikus-Neurinom, gebogen, Luer-Lock, 17 cm
Suction sickle knife for acoustic neuroma, curved, Luer-Lock, 17 cm

10-830-17



Saug-Kürette für Akustikus-Neurinom, gebogen, Luer-Lock, 17 cm
Suction curette for acoustic neuroma, curved, Luer-Lock, 17 cm

10-831-17



Saug-Dissektor für Akustikus-Neurinom, links gebogen, Luer-Lock, 17 cm
Suction dissector for acoustic neuroma, left curved, Luer-Lock, 17 cm

10-832-17



Saug-Dissektor für Akustikus-Neurinom, rechts gebogen, Luer-Lock, 17 cm
Suction dissector for acoustic neuroma, right curved, Luer-Lock, 17 cm

10-833-17



07b Endoskopische/Mikroskopische Instrumente nach Prof. Panetti

Endoscopic/Microscopic Instruments by Prof. Panetti



Otoskop, Großbild, HD, 3 mm, 11 cm

Otoscope, large picture, HD, 3 mm, 11 cm

Art.-Nr./No.	Winkel / Angle
10-109-00	0°
10-109-30	30°
10-109-45	45°
10-109-70	70°

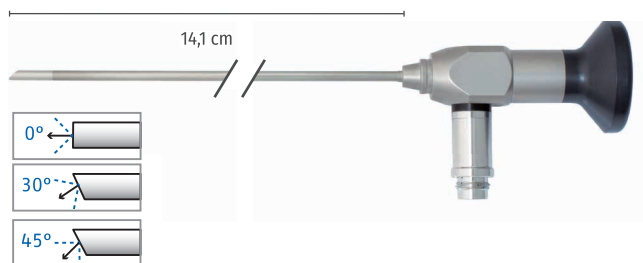

Otoskop, HD, Großbild, autoklavierbar, AD 3 mm, 14,1 cm

Otoscope, HD, large picture, autoclavable, OD 3 mm, 14.1 cm

Art.-Nr./No.	Winkel / Angle
10-090-00	0°
10-090-30	30°
10-090-45	45°

Unsere Ohrzängchen werden in drei unterschiedlichen Ausführungen angeboten. Um sie leichter unterscheiden zu können, wurden sie wie folgt markiert:

Beide Griffe blank: fein (1,8 mm)

Ein Griff geschwärzt: extrafein (1,5 mm)

Beide Griffe geschwärzt: superfein (1,3 mm)

Alle Ohrzängchen sind zur besseren Reinigung zerlegbar.

Our ear forceps are available in three different models.

For ease of recognition they are marked as follows:

delicate (both grips are shiny, 1.8 mm)

extra delicate (one grip is blackened, 1.5 mm)

super delicate (both grips are blackened, 1.3 mm)

All our ear forceps are dismountable for cleaning purposes.



Hartmann Ohrzängchen, gerieft, gerade, fein, 0,8 x 6 mm, 8 cm
Hartmann ear forceps, serrated, delicate, straight, 0.8 x 6 mm, 8 cm

10-276-02

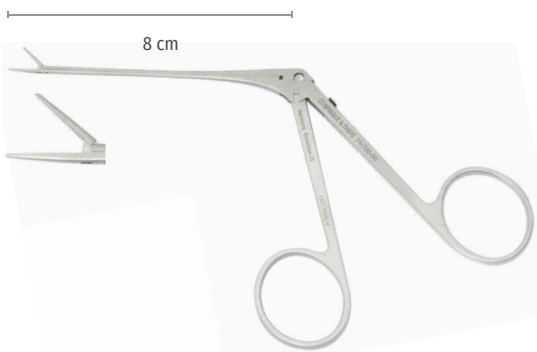

Hartmann Ohrzängchen, gerieft, gerade, fein, 0,8 x 7 mm, 8 cm
Hartmann ear forceps, serrated, delicate, straight, 0.8 x 7 mm, 8 cm

10-700-00

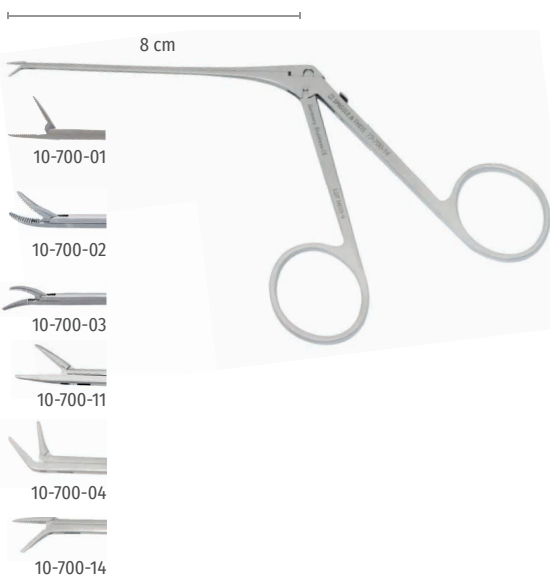

Hartmann Ohrzängchen, fein, 0,8 x 4 mm, 8 cm

Hartmann ear forceps, delicate, 0.8 x 4 mm, 8 cm

Art.-Nr./No.	Beschreibung / Description
10-700-01	gerade, gerieft / straight, serrated
10-700-11	gerade, glatt / straight, smooth
10-700-02	rechts gebogen, gerieft / curved right, serrated
10-700-03	links gebogen, gerieft / curved left, serrated
10-700-04	aufwärts gebogen, gerieft curved upwards, serrated
10-700-08	rechts, gerieft, horizontal öffnend right, serrated, horizontally opening
10-700-09	links, gerieft, horizontal öffnend left, serrated, horizontally opening
10-700-14	abwärts gebogen, gerieft curved downwards, serrated



08 Ohrzängchen

Ear forceps

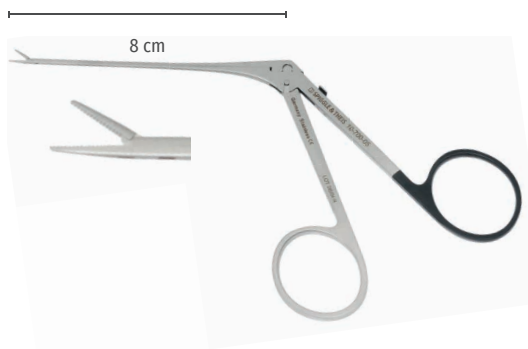

Hartmann Ohrzängchen, gerieft, extrafein, gerade, 0,6 x 4 mm, Schafthöhe 1,5 mm, 8 cm
Hartmann ear forceps, serrated, extra delicate, straight, 0.6 x 4 mm, shaft height 1.5 mm, 8 cm

10-700-05

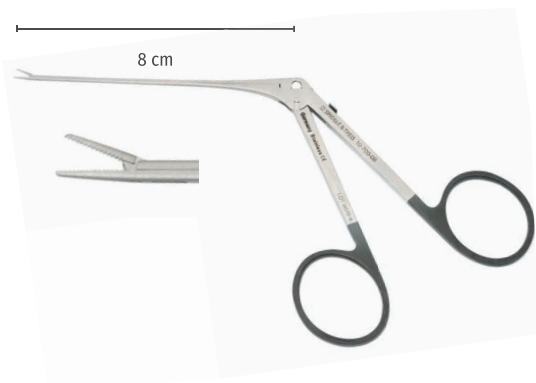

Hartmann Ohrzängchen, gerieft, superfein, gerade, 0,6 x 4 mm, Schafthöhe 1,3 mm, 8 cm
Hartmann ear forceps, serrated, super delicate, straight, 0.6 x 4 mm, shaft height 1.3 mm, 8 cm

10-700-06

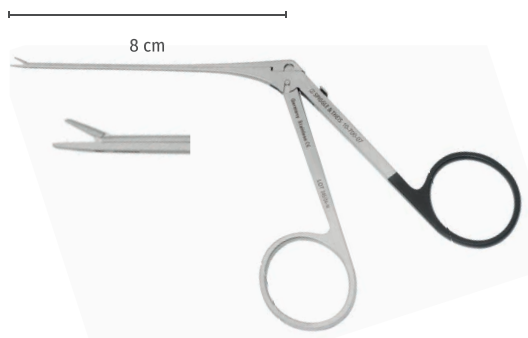

Fisch Ohrzängchen, extrafein, glatt, 0,6 x 3,5 mm, 8 cm
Fisch ear forceps, extra delicate, smooth, 0.6 x 3.5 mm, 8 cm

10-700-07



Hartmann Ohrzängchen, gerieft, gerade, fein, selbst schließend, 0,8 x 4 mm, 8 cm
Hartmann ear forceps, serrated, delicate, straight, self closing, 0.8 x 4 mm, 8 cm

10-701-00

08 Ohrzängchen

Ear forceps

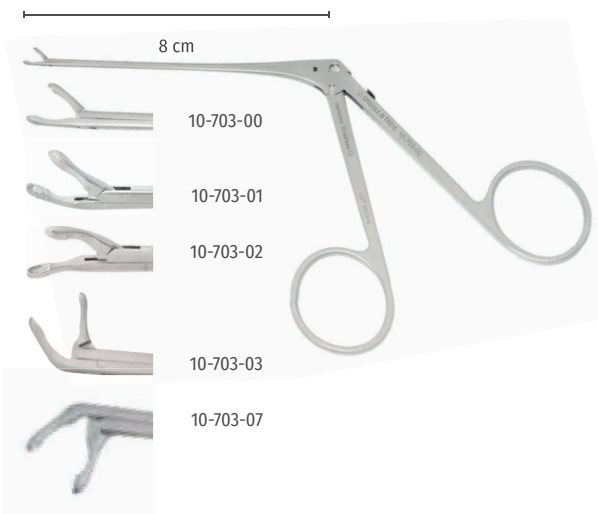

Mikro Ohrzängchen, ovale Löffel, fein, 0,8 x 1,3 mm, 8 cm
Micro ear forceps, oval cups, delicate, 0.8 x 1.3 mm, 8 cm

Art.-Nr./No.	Beschreibung / Description
10-703-00	gerade / straight
10-703-01	rechts gebogen / curved right
10-703-02	links gebogen / curved left
10-703-03	aufwärts gebogen / curved upwards
10-703-07	abwärts gebogen / curved downwards



Mikro Ohrzängchen, ovale Löffel, gerade, extrafein, 0,5 x 1 mm, 8 cm
Micro ear forceps, oval cups, straight, extra delicate, 0.5 x 1 mm, 8 cm

10-703-04

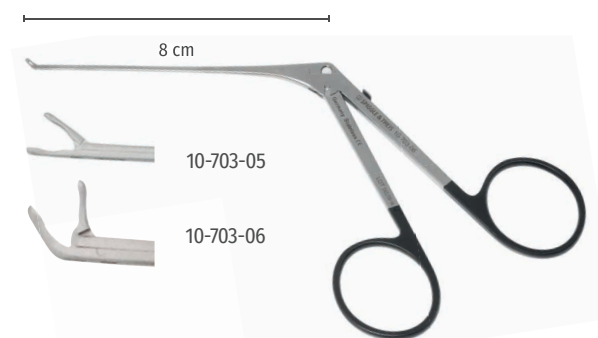

Mikro Ohrzängchen, superfein, ovale Löffel, 0,5 x 1 mm, 8 cm
Micro ear forceps, super delicate, oval cups, 0.5 x 1 mm, 8 cm

Art.-Nr./No.	Beschreibung / Description
10-703-05	gerade / straight
10-703-06	aufwärts gebogen / curved upwards



08 Ohrzängchen

Ear forceps

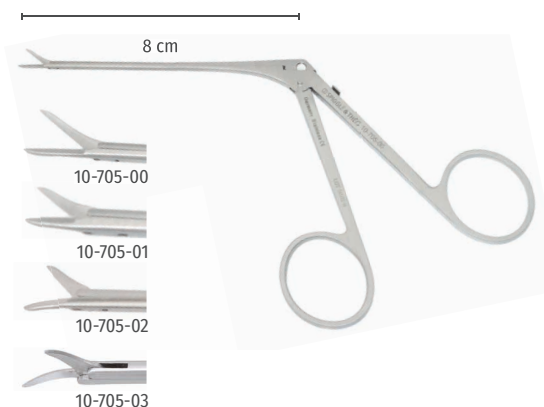

Bellucci Ohrscherchen, fein, 8 cm
Bellucci ear scissors, delicate, 8 cm

Art.-Nr. Art.-No.	Größe Size (mm)	Beschreibung Description
10-705-00	8	gerade / straight
10-705-01	4	gerade / straight
10-705-02	4	rechts gebogen / curved right
10-705-03	4	links gebogen / curved left
10-705-04	4	aufwärts gebogen / curved upwards
10-705-08	8	rechts gebogen / curved right
10-705-09	8	links gebogen / curved left

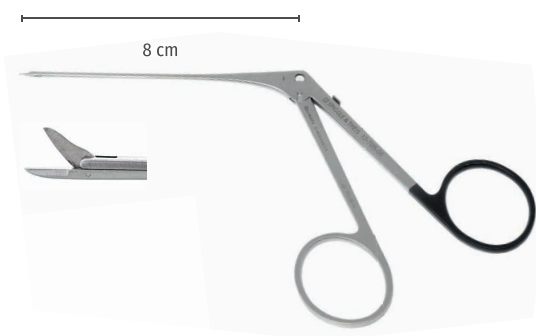

**House-Bellucci Ohrscherchen, gerade, extrafein,
 3 x 1,5 mm, 8 cm**
**House-Bellucci ear scissors, straight, super delicate,
 3 x 1.5 mm, 8 cm**

10-705-05



**House-Bellucci Ohrscherchen, gerade, superfein,
 2 x 1,3 mm, 8 cm**
**House-Bellucci ear scissors, straight, super delicate,
 2 x 1.3 mm, 8 cm**

10-705-06

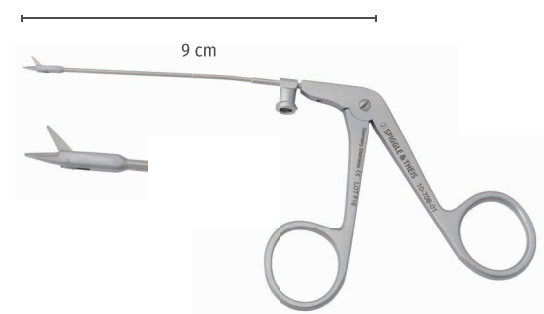

**Wullstein Rohrschaft Ohrscherchen,
 leicht gebogen, Spülkanal, 4 mm Schneidenlänge, 9 cm**
**Wullstein tubular shaft micro scissors,
 slightly curved, irrigation channel, 4 mm blade, 9 cm**

Art.-Nr./No.	Beschreibung / Description
10-706-01	gerade / straight
10-706-02	aufwärts gebogen / curved upwards
10-706-03	rechts gebogen / curved right
10-706-04	links gebogen / curved left

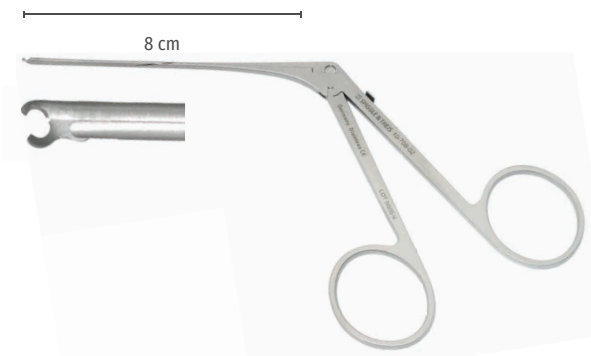

Fisch Crurotomie Scherchen, 8 cm

Fisch crurotomy scissors, 8 cm

Art.-Nr./No.	Beschreibung / Description
10-708-01	rechts gebogen / curved right
10-708-02	links gebogen / curved left

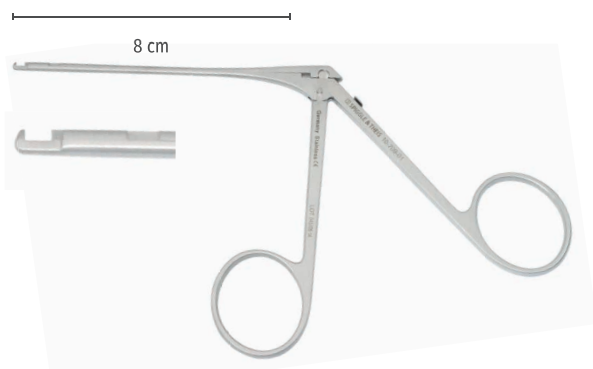

Dieter Hammerkopfstanze, 8 cm

Dieter malleus nipper, 8 cm

Art.-Nr./No.	Beschreibung / Description
10-709-01	aufwärts schneidend / upwards cutting
10-709-02	abwärts schneidend / downwards cutting

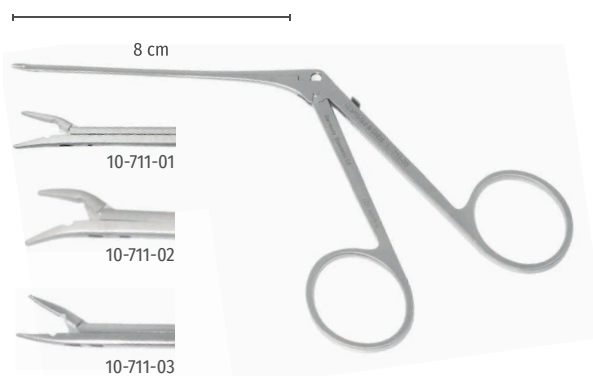

McGee Drahtschließzängchen, 0,8 x 3,5 mm, 8 cm

McGee wire closing forceps, 0,8 x 3.5 mm, 8 cm

Art.-Nr./No.	Beschreibung / Description
10-711-01	gerade / straight
10-711-02	rechts gebogen / curved right
10-711-03	links gebogen / curved left



08 Ohrzängchen

Ear forceps

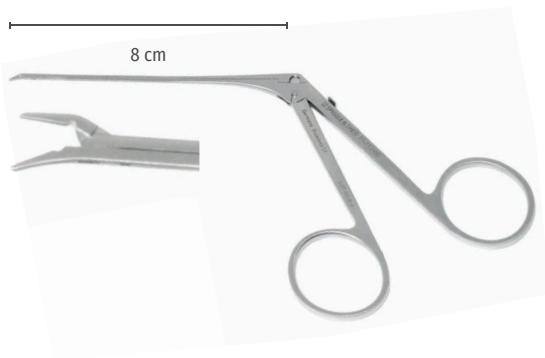

Fisch-McGee Drahtschließzängchen, gerade, 0,6 x 3,5 mm, 8 cm
Fisch-McGee wire closing forceps, straight, 0.6 x 3.5 mm, 8 cm

10-712-00



**Müller Drahtschließzängchen,
0,8 x 3,5 mm, gerade, bogenförmiges Maulteil, 8 cm**
Müller wire closing forceps, straight,
0.8 x 3.5 mm, rounded tip, 8 cm

10-713-00



Greven Drahtschließzängchen, gerade, 0,8 x 5 mm, 8 cm
Greven wire closing forceps, straight, 0.8 x 5 mm, 8 cm

10-714-00



**Kürzzängchen für Mittelohr-Implantate,
gerade, 1,4 x 4 mm, 8 cm**
Shortening forceps for middle ear implants,
straight, 1.4 x 4 mm, 8 cm

10-715-00

09 Mess- und Kürzinstrumente

Measuring and Shortening Instruments

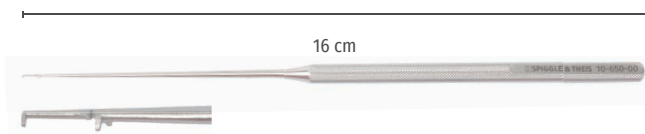

**Referenz-Instrument für Stapes-Prothesen,
3,5 / 4,0 / 4,5 mm, 16 cm**

Reference instrument for stapes prostheses,
3.5 / 4.0 / 4.5 mm, 16 cm

10-650-00

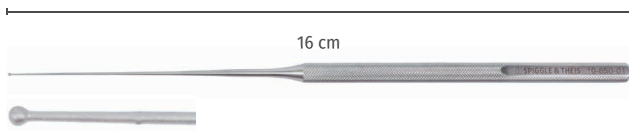

Referenz-Instrument für Stapes-Prothesen, Typ Tübingen

Reference instrument for stapes prostheses, type Tübingen

10-650-01

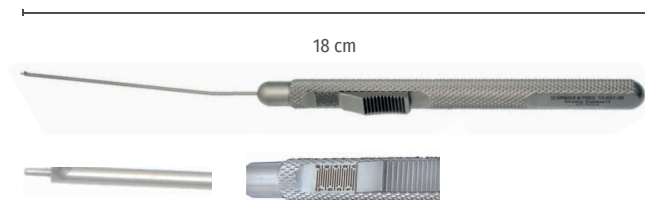

**Referenz-Instrument für Mittelohrprothesen,
verschiebbar von 0-8 mm, 18 cm**

Reference instrument for middle ear prostheses,
slide button control from 0-8 mm, 18 cm

Art.-Nr./No.	Beschreibung / Description
10-651-00	nicht zerlegbar / non-dismountable
10-652-00	zerlegbar / dismountable

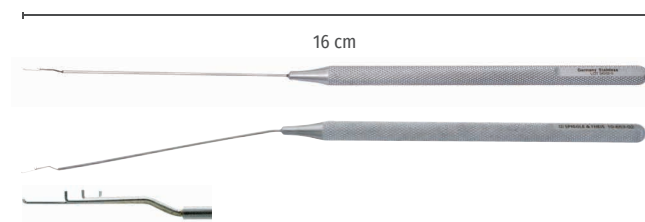

**Fisch Referenz-Instrument für Stapes-Prothesen,
3,5 / 4,0 / 4,5 mm, 16 cm**

Fisch reference instrument for stapes prostheses,
3.5 / 4.0 / 4.5 mm, 16 cm

Art.-Nr./No.	Beschreibung / Description
10-653-01	gerade / straight
10-653-02	gebogen / curved

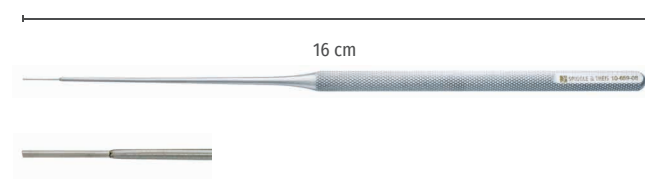

Fisch Referenz-Zylinder für Stapes-Prothesen, 16 cm

Fisch reference caliper for stapes prostheses, 16 cm

Art.-Nr./No.	AD / OD (mm)
10-659-04	0,4
10-659-06	0,6
10-659-08	0,8



09 Mess- und Kürzinstrumente

Measuring and Shortening Instruments

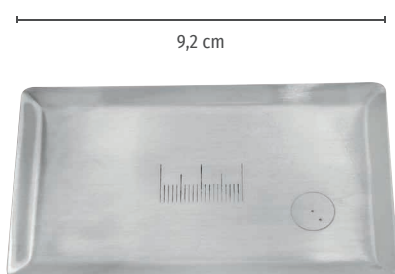

Präparier-Tablett aus Edelstahl, mit Skala, 92 x 54 mm
Preparation tray, stainless steel, with scale, 92 x 54 mm

10-735-00



Fisch Schneide- und Präparierblock für PTFE-Stapes-Prothesen
Fish cutting and preparation jig for PTFE stapes prostheses

Art.-Nr./No.	Größe / Size (mm)
10-738-04	0,4
10-738-06	0,6

09 Mess- und Kürzinstrumente

Measuring and Shortening Instruments



Schneidblock für PTFE Stapesprothesen, 0,4 und 0,6 mm

Piston cutting jig for PTFE stapes prostheses, 0.4 and 0.6 mm

10-740-01



Schuknecht Drahtbiegegerät für Stapes-Prothesen, zerlegbar

Schuknecht wire bending die for stapes prostheses, dismantlable

10-742-00



PTFE-Schutzhülse mit Fenster für Ohrzängchen,

11,5 cm, autoklavierbar, 10 Stück pro Box

**PTFE protective sleeve for ear forceps, with window,
11.5 cm, autoclavable, 10 pieces per box**

10-719-00



10 Allgemeines

Miscellaneous

Geschützte Oberfläche für alle SPIGGLE & THEIS Instrumente macht das Instrument weitgehend resistent gegen mechanische und chemische Einflüsse. Reduziert Licht- und Laser-Reflektion. Einfach bei Ihrer Bestellung "TAN" hinter die jeweilige Artikel-Nummer setzen.



A protective surface for all SPIGGLE & THEIS instruments makes the instruments resistant to mechanical and chemical influences whilst reducing light and laser reflections. Order by simply adding "TAN" behind the respective article number.



Heermann Ohrzängchen, Rohrschaft leicht gebogen, Spülkanal, gerieft, 9,6 cm
Heermann ear forceps, tubular model, shaft slightly curved, irrigation channel, serrated, 9.6 cm

Art.-Nr. Art.-No.	Größe Size (mm)	Maulteil Jaws
10-716-00	9 x 2	gerade / straight
10-716-02	9 x 2	links gebogen / left curved
10-716-03	9 x 2	rechts gebogen / right curved



Metalstand für 6 Ohrzängchen
Metal stand for 6 ear forceps

10-718-00

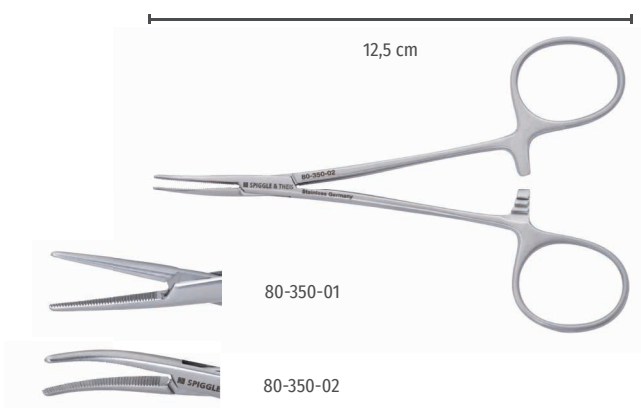

Halsted Mosquito-Klemme, anatomisch, 12,5 cm
Halsted-Mosquito haemostatic forceps, anatomical, 12.5 cm

Art.-Nr./No.	Beschreibung / Description
80-350-01	gerade / straight
80-350-02	gebogen / curved



Präparierplatte aus Glas, eine Seite angeraut, 9,5 x 7 x 0,5-0,6 cm
Cutting block, glass, one side silk finished, 9.5 x 7 x 0.5-0.6 cm

10-733-09



Präparierblock aus Teflon, 8 x 4 x 1 cm
Cutting block, PTFE, 8 x 4 x 1 cm

10-733-10

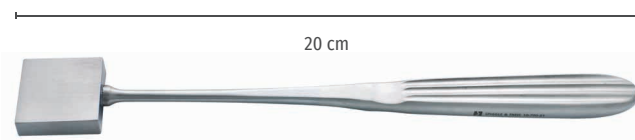

Heermann Hammer, 20 cm / Heermann mallet, 20 cm

10-720-21



Heermann Handgriff, schwarz / Heermann handle, black

Art.-Nr./No.	Größe / Size
10-722-13	13 cm, groß / large
10-723-09	9 cm, klein / small



Williger Elevatorium, gebogen, 16 cm
Williger elevator, curved, 16 cm

1-1010/05



Heermann Hohlmeißel, gebogen, mit Fähnchen, 12 cm
Heermann gouge, curved, with tab, 12 cm

Art.-Nr./No.	Größe / Size (mm)
10-726-10	1,0
10-726-15	1,5
10-726-30	3,0



10 Allgemeines

Miscellaneous



Heermann Mikrohäkchen, mit Fähnchen, 12,5 cm
Heermann micro hook, with tab, 12.5 cm

Art.-Nr./No.	Größe / Size
10-727-01	1
10-727-02	2
10-727-03	3
10-727-04	4

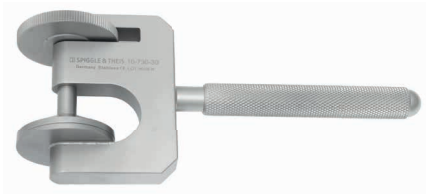

Shea Venenpresse / Shea vein press

Art.-Nr./No.	Größe / Size (mm)
10-730-16	16
10-730-30	30

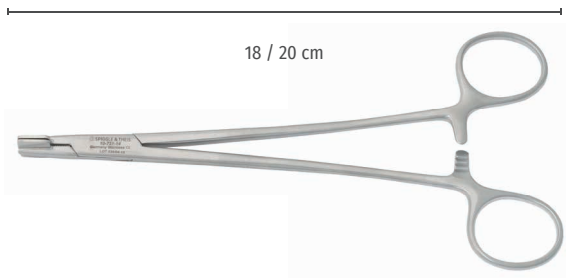

House Quetsch-Zange / House pressure forceps

Art.-Nr./No.	Länge / Length (cm)	Größe / Size (mm)
10-731-14	18	11 x 14
10-731-30	20	30 x 30

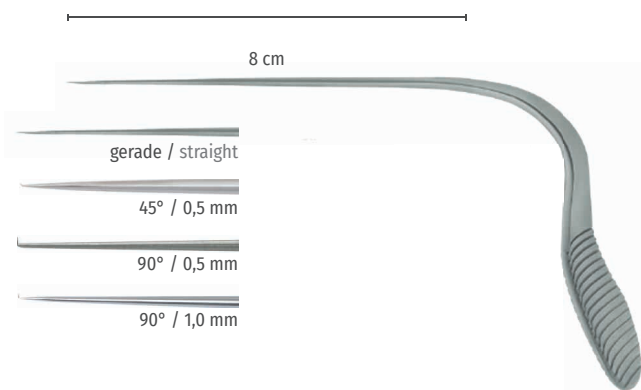

Zöllner Mikroinstrumente, 8 cm / Zöllner micro instruments, 8 cm

Art.-Nr. Art.-No.	Hakenlänge Length of hook (mm)	Winkel Angle
10-639-01		Nadel gerade, spitz needle straight, pointed
10-639-02	0,5	45° aufwärts / upward
10-639-03	0,5	45° abwärts / downwards
10-639-04	0,5	90° aufwärts / upward
10-639-05	0,5	90° abwärts / downwards
10-639-06	1,0	90° aufwärts / upward
10-639-07	1,0	90° abwärts / downwards



**Drahtbiege- und Schneideschere,
Hartmetall, gezahnt, gewinkelt, 12 cm**
Wire bending and cutting scissors,
tungsten carbide, with teeth, angled, 12 cm

10-745-12

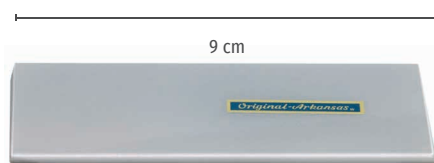

**Arkansas Ölstein, keilförmig, 9 x 4 cm,
zum Schleifen von feinen Instrumenten und Meißeln**
Arkansas oil whetstone, wedge-shaped, 9 x 4 cm,
for sharpening delicate instruments and chisels

10-747-00



**Flexibler Spannarm zur Verwendung mit selbsthaltenden
NNH-Spekula, mit Verlängerungsstange**
Flexible holding arm for use with self retaining nasal specula,
including holding rods

30-700-00



**Gelenkkloben zur Befestigung am OP-Tisch,
passend für 30-700-00 und 40-337-00**
Rotation clamp for fixation to operating table,
for 30-700-00 and 40-337-00

30-700-01



**Ohrspekulumhalter für flexiblen Spannarm,
passend für alle Ohrtrichter**
Ear speculum clamp for flexible holding arm,
suitable for all ear specula

10-750-00



**Endoskophalter für flexiblen Spannarm,
passend für alle Endoskope**
Endoscope clamp for flexible holding arm,
suitable for all endoscopes

10-751-00

10 Allgemeines

Miscellaneous



**Felsenbeinhalter Modell Würzburg,
Wanne aus rostfreiem Edelstahl, Kunststoffrahmen;
Felsenbein in jeder Position einstellbar**
Würzburg temporal bone holder, stainless steel bowl, plastic
frame; temporal bone can be set in all positions

10-755-00



Universal-Einführungszängchen für Paukenröhrchen, mit Spülkanal
Universal ventilation tube inserter, with irrigation channel

10-758-00



**Einführungszängchen für Kunststoff-Paukenröhrchen
mit je einem Mandrin für PR 1,0 mm und 1,2 mm Ø**
Ventilation tube insertion forceps with mandrin
for both VT 1.0 mm and 1.2 mm Ø

10-759-00



**T-Tube Einführungsinstrument, zerlegbar,
für T-Tubes mit 5 mm und 12 mm Länge**
T-tube insertion instrument, dismountable,
for t-tubes with 5 mm and 12 mm length

10-760-00



**Spezial Ölspray, Pflegespray für Instrumente sowie für
Hand- und Winkelstücke, UN 1950, Klasse 2, 5 F
(Druckgasflaschen), 500 ml**

Special Oilspray, Maintenance Spray for Instruments
and Drill Handpieces, UN 1950, Class 2, 5 F
(compressed gas cylinders), 500 ml

00-108-005



Metallschale / Metal bowl

Art.-Nr. Art.-No.		Durchmesser Diameter (mm)	Höhe Height (mm)	Fassungs- vermögen Capacity (ml)
80-501-01	B1	Ø 40	H=19	20
80-501-02	B2	Ø 60	H=39	60
80-501-03	B3	Ø 85	H=40	160
80-501-04	B4	Ø 110	H=55	400



**Metallbecher, mit Griff
Metal cup, with handle**

Art.-Nr. Art.-No.		Durchmesser Diameter (mm)	Höhe Height (mm)	Fassungs- vermögen Capacity (ml)
80-500-00		Ø 69	H=95	350



**Medizinbecher, Edelstahl, graduert
Medicine cup, stainless steel, graduated**

Art.-Nr. Art.-No.		Durchmesser Diameter (mm)	Höhe Height (mm)	Fassungs- vermögen Capacity (ml)
80-503-03		Ø 50	H=25	30
80-504-05		Ø 53	H=45	50



**Lösungsschale, Edelstahl
Solution bowl, stainless steel**

Art.-Nr. Art.-No.		Durchmesser Diameter (mm)	Höhe Height (mm)	Fassungs- vermögen Capacity (ml)
80-505-10		Ø 72	H=33	100
80-505-20		Ø 87	H=50	200
80-506-30	B1	Ø 95	H=60	300
80-507-40	B2	Ø 120	H=70	500
80-509-75	B3	Ø 150	H=75	750



**Tablettenschale, Edelstahl, Ø 65 mm, H=20 mm
Tablet dish, stainless steel, Ø 65 mm, H=20 mm**

80-512-00



Petrishale, Klarglas, mit Deckel / Petri dish, clear glass, with lid

Art.-Nr./No.	AD / OD (mm)	Höhe / Height (mm)
80-515-06	60	15
80-515-08	80	15
80-515-10	150	20



10 Misceláneos

Miscellaneous



80-519-00



80-519-01



80-519-02



80-519-03

Medikamenten-Schälchen, Dappenglas, farbig, Ø 3,2 cm Medication dish, dappen-glass, colored, Ø 3.2 cm

Art.-Nr./No.	Farbe / Color
80-519-00	kristall / crystal
80-519-01	grün / green
80-519-02	rosa / pink
80-519-03	topas / topaz



Porzellan-Schälchen, rund, mit Ausguss China bowl, round, with spout

Art.-Nr./No.	Durchmesser / Diameter (cm)
80-520-06	Ø 8
80-520-08	Ø 10



Nierenschale, Edelstahl / Kidney bowl, stainless steel

Art.-Nr./No.	Größe / Size (cm)
80-525-17	17,5
80-525-25	25,0



Kornzangen-Behälter, Edelstahl Forceps holder, stainless steel

Art.-Nr. Art.-No.	Durchmesser Diameter (cm)	Höhe Height (cm)
80-528-13	Ø 5,0	13,5
80-528-18	Ø 5,0	18,0
80-528-20	Ø 9,5	20,0



Kornzangen-Behälter, Glas, Edelstahldeckel mit Ausschnitt, Ø 8 cm, Höhe 20 cm Forceps holder, glass, stainless steel lid with opening, Ø 8 cm, height 20 cm

80-530-20



Norm-Sterilisations-Container, Boden geschlossen

Norm sterilization container, bottom closed

Art.-Nr. Art.-No.	Größe Size	Dimension (außen) Dimension (outside) (mm)
80-631-10	1/2	297 x 274 x 88
80-631-12	1/2	297 x 274 x 123
80-631-14	1/2	297 x 274 x 138
80-631-21	1/2	297 x 274 x 188
80-641-14	3/4	462 x 274 x 138
80-661-12	1	585 x 274 x 123
80-661-14	1	585 x 274 x 138
80-661-21	1	585 x 274 x 188



Ventildeckel für Norm-Sterilisations-Container

Valve lid for norm sterilization container

Art.-Nr./No. 1/2 299 x 278 mm	Art.-Nr./No. 3/4 462 x 278 mm	Art.-Nr./No. 1 585 x 278 mm
80-632-00 ●	80-642-00 ●	80-662-00 ●
80-632-01 ●	80-642-01 ●	80-662-01 ●
80-632-02 ●	80-642-02 ●	80-662-02 ●
80-632-03 ●	80-642-03 ●	80-662-03 ●
80-632-04 ●	80-642-04 ●	80-662-04 ●
80-632-05 ●	80-642-05 ●	80-662-05 ●

Edelstahl-Siebkorb, Geflecht, Fallgriffe

Stainless-steel wire basket, Geflecht, Fallgriffe

Art.-Nr./No.	Größe / Size (mm)
80-671-20	255 x 245 x 50
80-671-25	255 x 245 x 70
80-671-40	405 x 255 x 70
80-671-60	485 x 255 x 70

Aluminium-Kennzeichnungs-Schild, 20 Zeichen, 56 x 17 mm

Coding label, 20 characters, 56 x 17 mm

Art.-Nr./No.	Farbe / Color
80-681-01	schwarz / black
80-681-02	rot / red
80-681-03	braun / brown
80-681-04	grün / green
80-681-05	gelb / yellow
80-681-06	lila / purple
80-681-07	blau / blue



Einweg-Container-Siegel, blau, 100 Stück/Box

Container seal, disposable, blue, 100 pieces/box

80-683-10

Indikator-Klebe-Etikett, Lasche rechts, 100 Stück/Box

Adhesive indicator label, latch right side, 100 pieces/box

80-684-10

Silikonmatte, blau, perforiert, 440 x 230 mm

Silicon mat, blue, perforated, 440 x 230 mm

80-675-00

Klemmschild aus Edelstahl, hitzebeständig, 6 x 4 cm, 25 Stück/Box

Label holder with clip, stainless steel, heat resistant, 6 x 4 cm, 25 pieces/box

80-688-00



11 Sterilisationssysteme

Sterilization Systems



Endoskopie-Siebkorb mit Deckel, Edelstahl, elektroliert
Endoscope container with lid, stainless steel, e-polished

Art.-Nr./No.	Größe / Size (cm)
80-690-01	29 x 8 x 5,2 für 1 Endoskop 29 x 8 x 5,2 for 1 endoscope
80-690-02	29 x 8 x 5,2 für 2 Endoskope 29 x 8 x 5,2 for 2 endoscopes



Endoskopie-Siebkorb mit Deckel, Edelstahl, elektroliert
Endoscope container with lid, stainless steel, e-polished

Art.-Nr./No.	Größe / Size (cm)
80-691-01	46 x 8 x 5,2 für 1 Endoskop 46 x 8 x 5,2 for 1 endoscope
80-692-01	67 x 8 x 5,2 für 1 Endoskop 67 x 8 x 5,2 for 1 endoscope



**Sterilisations-System "Instru-Safe" für
Mikro-Ohr-Instrumentarium komplette Ausstattung / 2 Boxen:**
Sterilizing & protection system "Instru-Safe"
for micro ear surgery complete equipment / 2 boxes

80-600-00

Bestehend aus:

- Instrumentenbox für feine Instrumente
- Instrumentenbox für große Instrumente
- 2 Module "Ohrzängchen" (Art.-Nr. 80-601-01)
- 2 Module "Häkchen/Messer" (Art.-Nr. 80-601-08)
- 1 Modul "Ohrtrichter" (Art.-Nr. 80-601-03)
- 1 Modul "Mikroaugröhrchen" (Art.-Nr. 80-601-04)

Consisting of:

- Instrument box for delicate instruments
- Instrument box for larger instruments
- 2 trays "ear forceps" (Art.-No. 80-601-01)
- 2 trays "hooks and knives" (Art.-No. 80-601-08)
- 1 tray "ear specula" (Art.-No. 80-601-03)
- 1 tray "micro suction tubes" (Art.-No. 80-601-04)

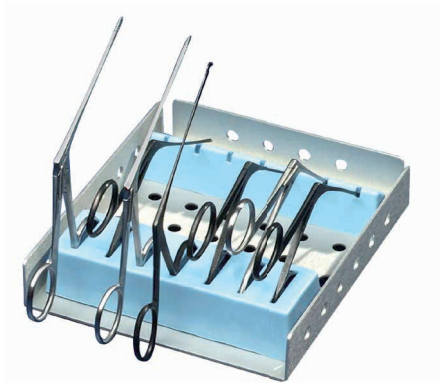

Modul "Ohrzängchen", 14,8 x 13,0 x 2,5 cm

Tray "Ear forceps", 14.8 x 13.0 x 2.5 cm

80-601-01



Modul "Häkchen/Messer", 19,4 x 13,0 x 2,5 cm

Tray "Hooks and knives", 19.4 x 13.0 x 2.5 cm

80-601-02



Modul "Ohrtrichter", 8,9 x 13,0 x 2,5 cm

Tray "Ear specula", 8.9 x 13.0 x 2.5 cm

80-601-03



Modul "Mikroaugröhrchen", 8,9 x 13,0 x 2,5 cm

Tray "Micro suction tubes", 8.9 x 13.0 x 2.5 cm

80-601-04

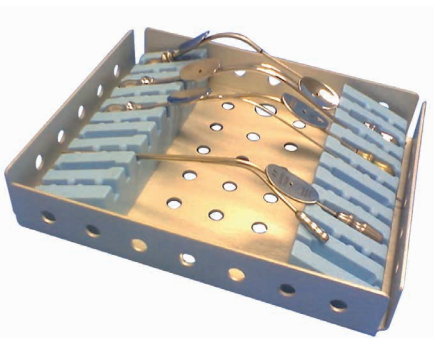

Modul "Baron Saugrohre", 14,9 x 13,0 x 2,5 cm

Tray "Baron suction tubes", 14.9 x 13.0 x 2.5 cm

80-601-05

11 Sterilisationssysteme

Sterilization Systems

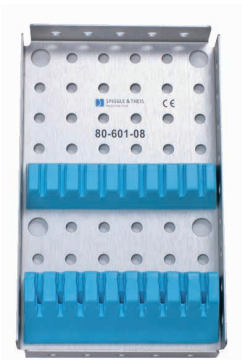

Modul "Häkchen/Messer II", 19,4 x 11,7 x 2,5 cm
Tray "Hooks and knives II", 19.4 x 11.7 x 2.5 cm

80-601-08



Instrumentenbox für feine Instrumente, 50,0 x 24,5 x 8,0 cm
Instrument box for delicate instruments, 50.0 x 24.5 x 8.0 cm

80-602-30

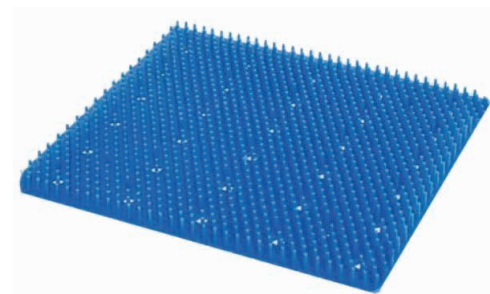

Noppenmatte, fein, zuschneidbar, 48,3 x 33,0 x 1,8 cm
Fingermatte, fine, custom cut, 48.3 x 33.0 x 1.8 cm

80-602-32

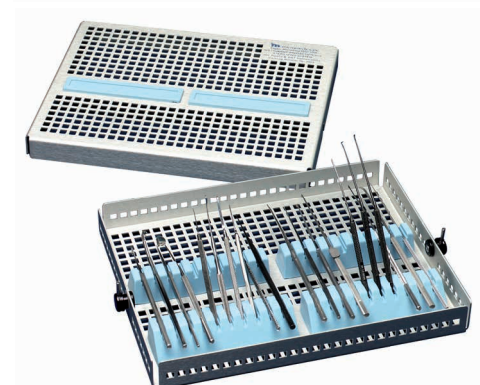

Instrumenten Box mit Deckel
für 20 Häkchen/Messer, 27,9 x 22,2 x 3,8 cm
Instrument box with lid
for 20 hooks and knives, 27.9 x 22.2 x 3.8 cm

80-603-01

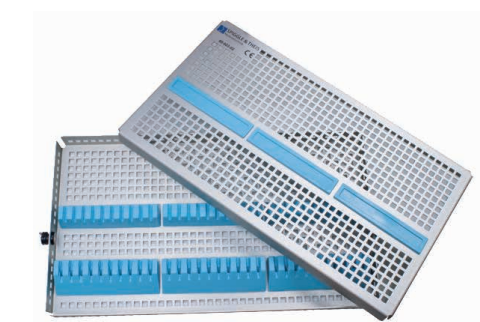

Instrumenten Box mit Deckel
für 30 Häkchen/Messer, 38,1 x 22,2 x 3,8 cm
Instrument box with lid
for 30 hooks and knives, 38.1 x 22.2 x 3.8 cm

80-603-02

11 Sterilisationssysteme

Sterilization Systems



Instrumenten Box mit Deckel

für 10 Håkchen/Messer, 12,7 x 22,2 x 3,8 cm

Instrument box with lid for 10 hooks and knives, 12.7 x 22.2 x 3.8 cm

80-603-03



Instrumenten Box mit Deckel für

15 Mikro-Instrumente, 21,5 x 22,2 x 3,8 cm

Instrument box with lid for 15 micro instruments,
21.5 x 22.2 x 3.8 cm

80-603-04

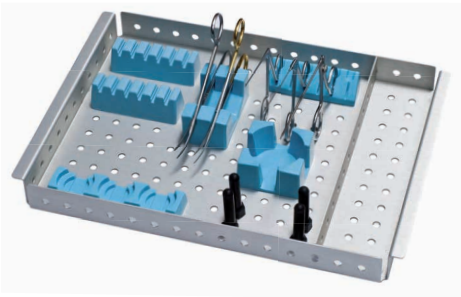

Sterilisations-System "Instru-Safe"

für Parazentese-Set zur Aufnahme von Ohrtrichtern,
Ohrzångchen, Håkchen und Nadeln

Sterilizing and protection set "Instru-Safe" for myringotomy set,
holds ear-specula, forceps, knives and hooks

80-605-00

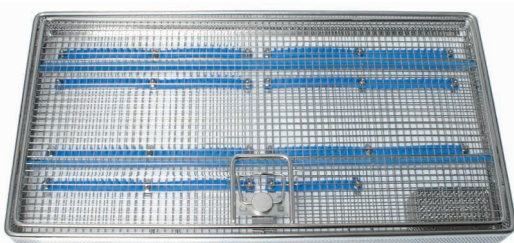

HNO-Spülkorb, Edelstahl mit abnehmbarem Deckel,
Kleinteilekorb und Instrumentenaufnahmen,
epoliert, 480 x 250 x 40 mm

ENT instrument tray, stainless steel with removable lid, small parts
basket and instrument holders, e-polished, 480 x 250 x 40 mm

80-695-00

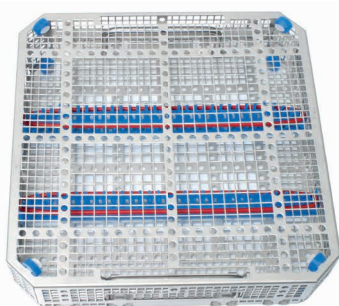

Spül- und Sterilisierkorb

für Mikro-Endoskope, Edelstahl, 24,5 x 24,5 cm

Irrigation- and sterilization basket

for micro endoscopes, stainless steel, 24.5 x 24.5 cm

80-697-00

Configuration
upon request



12 Endoskopische/Mikroskopische Instrumente Set nach Prof. Panetti 10-890-00

Endoscopic/Microscopic Instrument Set by Prof. Panetti 10-890-00

Bestehend aus / Consisting of:

- | | | | |
|-----------|--|-----------|--|
| 10-800-12 | 1x Saug-Dissektor für Trommelfell, einfach links gebogen, 3 mm
1x Suction dissector for ear drum, single curved, left side, 3 mm | 10-703-03 | 1x Mikro-Ohrzängchen, ovale Löffel, fein, 0,8 x 1,3 mm, aufgebogen, 8 cm / 1x Micro ear forceps, oval cups, fine, 0.8 x 1.3 mm, upwards curved, 8 cm |
| 10-801-12 | 1x Saug-Dissektor für Trommelfell, einfach rechts gebogen, 3 mm
1x Suction dissector for ear drum, single curved, right side, 3 mm | 10-703-04 | 1x Mikro Ohrzängchen, ovale Löffel, gerade, extrafein, 0,5 x 1,0 mm, 8 cm / 1x Micro ear forceps, oval cups, extra fine, 0.5 x 1.0 mm, straight, 8 cm |
| 10-802-12 | 1x Saug-Dissektor für Sinus Tympani, doppelt rückwärts links gebogen, 6 mm / 1x Suction dissector for sinus tympani, double curved, backwards, left side, 6 mm | 10-703-07 | 1x Mikro-Ohrzängchen, ovale Löffel, fein, 0,8 x 1,3 mm, abgebogen, 8 cm / 1x Micro ear forceps, oval cups, fine, 0.8 x 1.3 mm, downwards curved 8 cm |
| 10-803-12 | 1x Saug-Dissektor für Sinus Tympani, doppelt rückwärts rechts gebogen, 6 mm / 1x Suction dissector for sinus tympani, double curved, backwards, right side, 6 mm | 10-446-11 | 1x Preyer Wundsperrer, schmales Blatt beidseits mit Noppen, 11 cm, zerlegbar Griff vergoldet / 1x Preyer retractor, slim blade, gold plated grip, studded on both sides, 11 cm, detachable |
| 10-804-12 | 1x Saug-Dissektor für Attik, doppelt vorwärts links gebogen, 6 mm
1x Suction dissector for atticus, double curved, forwards, left side, 6 mm | 10-109-30 | 1x Otoskop, Großbild, HD, 3 mm, 30° (wahlweise 0°, 45° oder 70°), 110 mm / 1x Otoloscope, large picture, HD, 3 mm, 30° (optional 0°, 45° or 70°), 110 mm |
| 10-805-12 | 1x Saug-Dissektor für Attik, doppelt vorwärts rechts gebogen, 6 mm
1x Suction dissector for atticus, double curved, forwards, right side, 6 mm | | |
| 10-806-12 | 1x Saug-Mikrohäkchen, 45°, 1,0 mm
1x Suction micro hook, 45°, 1.0 mm | | |
| 10-807-12 | 1x Saug-Mikrohäkchen, 45°, 2,0 mm
1x Suction micro hook, 45°, 2.0 mm | | |
| 10-808-12 | 1x Saug-Rundschnittmesser, 45°, Saugöffnung links, 2,5 mm
1x Suction separator, 45°, suction left side, 2.5 mm | | |
| 10-811-12 | 1x Saug-Rundschnittmesser, 45°, Saugöffnung rechts, 2,5 mm
1x Suction separator, 45°, suction right side, 2.5 mm | | |
| 10-810-12 | 1x Saug-Messer oval, seitliche Öffnung links, 2,5 mm
1x Suction oval knife, lateral opening left side, 2.5 mm | | |
| 10-813-12 | 1x Saug-Dissektor, einfach gebogen, links, sehr fein, Luer-Lock
1x Suction dissector lateral opening left side, very fine | | |
| 10-814-12 | 1x Saug-Dissektor, einfach gebogen, rechts, sehr fein, Luer-Lock
1x Suction dissector lateral opening right side, very fine | | |
| 10-816-12 | 1x Saug-Kürette, gebogen / 1x Suction curette, curved | | |
| 10-851-00 | 2x Saugadapter, drehbar, 55° gebogen, Luer-Lock männlich, Schlauchansatz / 2x Rotatable suction adapter, 55° curved, luer-lock male, hose connector | | |

Ergänzung 10-890-99

Supplement 10-890-99

- | | |
|-----------|--|
| 10-840-01 | 1x System-Siebkorb für Panetti-Instrumentarium /
1x System screen basket for Panetti instruments |
| 10-845-01 | 2x Spülkomponente für System-Siebkorb Panetti-Instrumentarium
2x Irrigation component for system screen basket Panetti instruments |
| 70-266-02 | 1x Hochleistungs-Fiberglas-Lichtleitkabel, 3,5 mm, 1800 mm, endoskopseitig 90° abgewinkelt, Storz/Storz-Adapter, autoklavierbar / High definition fibre light cable, 3.5 mm, 1800 mm, endoscope side angled 90°, Storz/Storz connections, autoclavable |

Supplement for sales in EU (outside the EU only on request)

12 Endoskopische/Mikroskopische Instrumenten-Set nach Prof. Panetti 10-895-00

Endoscopic/Microscopic Instrument Set by Prof. Panetti 10-895-00

Prof. Panetti Set für Endoskopische/Mikroskopische Instrumente, wie 10-890-00, jedoch ohne Otoskop

Prof. Panetti Endoscopic/Microscopic Instrument Set, as 10-890-00, yet without Otoloscope

Ergänzung 10-895-99

Supplement 10-895-99

- | | |
|-----------|---|
| 10-840-01 | 1x System-Siebkorb für Panetti-Instrumentarium /
1x System screen basket for Panetti instruments |
| 10-845-01 | 2x Spülkomponente für System-Siebkorb Panetti-Instrumentarium
2x Irrigation component for system screen basket Panetti instruments |

Supplement for sales in EU (outside the EU only on request)

12 Endoskopische/Mikroskopische Instrumente Set nach Prof. Panetti 10-896-00

Endoscopic/Microscopic Instrument Set by Prof. Panetti 10-896-00

Bestehend aus / Consisting of:

- | | | | |
|-----------|---|-----------|--|
| 10-800-12 | 1x Saug-Dissektor für Trommelfell, einfach links gebogen, 3 mm
1x Suction dissector for ear drum, single curved, left side, 3 mm | 10-703-04 | 1x Mikro Ohrzängchen, ovale Löffel, gerade, extrafein,
0,5 x 1,0 mm, 8 cm / 1x Micro ear forceps, oval cups, extra fine,
0.5 x 1.0 mm, straight, 8 cm |
| 10-801-12 | 1x Saug-Dissektor für Trommelfell, einfach rechts gebogen, 3 mm
1x Suction dissector for ear drum, single curved, right side, 3 mm | 10-109-30 | 1x Otoskop, Großbild, HD, 3 mm, 30° (wahlweise 0°,
45° oder 70°), 110 mm / 1x Otoscope, large picture, HD, 3 mm,
30° (optional 0°, 45° or 70°), 110 mm |
| 10-807-12 | 1x Saug-Mikrohäkchen, 45°, 2,0 mm
1x Suction micro hook, 45°, 2.0 mm | | |
| 10-808-12 | 1x Saug-Rundschnittmesser, 45°, Saugöffnung links, 2,5 mm
1x Suction separator, 45°, suction left side, 2.5 mm | | |
| 10-812-12 | 1x Saug-Messer oval, seitliche Öffnung rechts, 2,5 mm
1x Suction oval knife, lateral opening right side, 2.5 mm | | |
| 10-815-12 | 1x Saug-Sichelmesser gebogen, 13 cm
1x Suction sickle knife, curved, 13 cm | | |
| 10-851-00 | 1x Saugadapter, drehbar, 55° gebogen, Luer-Lock männlich,
Schlauchansatz / 1x Rotatable suction adapter, 55° curved,
luer-lock male, hose connector | | |

Ergänzung 10-890-99

Supplement 10-890-99

- | | |
|-----------|--|
| 70-266-02 | 1x Hochleistungs-Fiberglas-Lichtleitkabel, 3,5 mm, 1800 mm,
endoskopseitig 90° abgewinkelt, Storz/Storz-Adapter, autokla-
vierbar / High definition fibre light cable, 3.5 mm, 1800 mm,
endoscope side angled 90°, Storz/Storz connections, autocla-
vable |
| 10-841-01 | 1x System-Siebkorb für Panetti-Instrumentarium, klein
1x System screen basket for Panetti instruments, small |
| 10-845-01 | 1x Spülkomponente für System-Siebkorb Panetti-Instru-
mentarium / 1x Irrigation component for system screen
basket Panetti instruments |

Supplement for sales in EU (outside the EU only on request)



12 Bohrer-Set LowSpeed 10-908-00

Burs Set LowSpeed 10-908-00

Bestehend aus / Consisting of:

DR070010691	1x Diamant-Bohrer, mittlere Körnung, Ø 0,6 mm 1x Diamond bur, medium grain, Ø 0.6 mm	CR070010806	1x Osteotomie-Bohrer, HM, Ø 0,8 mm, 6 Schneiden 1x Osteotomy bur, TC, Ø 0.8 mm, 6 blades
DR070010891	1x Diamant-Bohrer, mittlere Körnung, Ø 0,8 mm 1x Diamond bur, medium grain, Ø 0.8 mm	CR070011006	1x Osteotomie-Bohrer, HM, Ø 1,0 mm, 6 Schneiden 1x Osteotomy bur, TC, Ø 1.0 mm, 6 blades
DR070011091	1x Diamant-Bohrer, mittlere Körnung, Ø 1,0 mm 1x Diamond bur, medium grain, Ø 1.0 mm	CR070011206	1x Osteotomie-Bohrer, HM, Ø 1,2 mm, 6 Schneiden 1x Osteotomy bur, TC, Ø 1.2 mm, 6 blades
DR070011491	1x Diamant-Bohrer, mittlere Körnung, Ø 1,4 mm 1x Diamond bur, medium grain, Ø 1.4 mm	CR070011606	1x Osteotomie-Bohrer, HM, Ø 1,6 mm, 6 Schneiden 1x Osteotomy bur, TC, Ø 1.6 mm, 6 blades
DR070011891	1x Diamant-Bohrer, mittlere Körnung, Ø 1,8 mm 1x Diamond bur, medium grain, Ø 1.8 mm	CR070012106	1x Osteotomie-Bohrer, HM, Ø 2,1 mm, 6 Schneiden 1x Osteotomy bur, TC, Ø 2.1 mm, 6 blades
DR070012191	1x Diamant-Bohrer, mittlere Körnung, Ø 2,1 mm 1x Diamond bur, medium grain, Ø 2.1 mm	CR070012708	1x Osteotomie-Bohrer, HM, Ø 2,7 mm, 8 Schneiden 1x Osteotomy bur, TC, Ø 2.7 mm, 8 blades
DR070012791	1x Diamant-Bohrer, mittlere Körnung, Ø 2,7 mm 1x Diamond bur, medium grain, Ø 2.7 mm	CR070013508	1x Osteotomie-Bohrer, HM, Ø 3,5 mm, 8 Schneiden 1x Osteotomy bur, TC, Ø 3.5 mm, 8 blades
DR070013191	1x Diamant-Bohrer, mittlere Körnung, Ø 3,1 mm 1x Diamond bur, medium grain, Ø 3.1 mm	CR070014510	1x Osteotomie-Bohrer, HM, Ø 4,5 mm, 10 Schneiden 1x Osteotomy bur, TC, Ø 4.5 mm, 10 blades
DR070014091	1x Diamant-Bohrer, mittlere Körnung, Ø 4,0 mm 1x Diamond bur, medium grain, Ø 4.0 mm	CR070015012	1x Osteotomie-Bohrer, HM, Ø 5,0 mm, 12 Schneiden 1x Osteotomy bur, TC, Ø 5.0 mm, 12 blades
DR070015091	1x Diamant-Bohrer, mittlere Körnung, Ø 5,0 mm 1x Diamond bur, medium grain, Ø 5.0 mm	CR070016014	1x Osteotomie-Bohrer, HM, Ø 6,0 mm, 14 Schneiden 1x Osteotomy bur, TC, Ø 6.0 mm, 14 blades
DR070016091	1x Diamant-Bohrer, mittlere Körnung, Ø 6,0 mm 1x Diamond bur, medium grain, Ø 6.0 mm	CR070017016	1x Osteotomie-Bohrer, HM, Ø 7,0 mm, 16 Schneiden 1x Osteotomy bur, TC, Ø 7.0 mm, 16 blades
DR070017091	1x Diamant-Bohrer, mittlere Körnung, Ø 7,0 mm 1x Diamond bur, medium grain, Ø 7.0 mm	BS23507034	1x Bohrerständer für 34 rotierende Instrumente der Länge 70 mm 1x Stand for 34 rotary instruments, length: 70 mm
CR070010506	1x Osteotomie-Bohrer, HM, Ø 0,5 mm, 6 Schneiden 1x Osteotomy bur, TC, Ø 0.5 mm, 6 blades		



12 Tympanoplastik/Stapesplastik-Set 10-900-00

Tympanoplasty/Stapesplasty Set 10-900-00

Bestehend aus / Consisting of:

10-420-11	2x Wullstein Wundsperrer, 3:3 Zähne, 11 cm, halbscharf 2x Wullstein retractor, 3:3 prongs, 11 cm, semi-sharp	10-642-04	1x Plester Fußplattenhäkchen, rund, 0,4 mm / 1x Plester footplate hook, round, 0.4 mm
10-428-11	1x Helms Wundsperrer, 2 Zähne rechts, Blatt mit Noppen links, 11,5 cm 1x Helms retractor, 2 prongs right, blade with studs, 11.5 cm	10-652-00	1x Referenz-Instrument, 0-8 mm, zerlegbar 1x Reference instrument, 0-8 mm, dismountable
10-429-11	1x Helms Wundsperrer, 2 Zähne links, Blatt mit Noppen rechts, 11,5 cm 1x Helms retractor, 2 prongs left, blade with studs right, 11.5 cm	10-658-03	1x Fußplatten-Perforator, 0,3 mm / Footplate-perforator, 0.3 mm
10-438-17	1x Fisch Wundsperrer mit Gelenken, 3:3 Zähne, halbscharf, 16,5 cm 1x Fisch retractor, adjustable, 3:3 prongs, semi-sharp, 16.5 cm	10-658-05	1x Fußplatten-Perforator, 0,5 mm / Footplate-perforator, 0.5 mm
20-100-01	1x Hartmann Nasen-Spekulum, für Erwachsene 1x Hartmann nose specula, for adults	10-738-04	1x Präparierblock für Stapesprothesen, 0,4 mm 1x Preparation jig for stapes prostheses, 0.4 mm
20-601-14	1x Joseph Schere, spitz-spitz, gebogen, 14,5 cm 1x Joseph scissors, pointed, curved, 14.5 cm	10-733-09	1x Präparierblock für Fascie und Knorpel, Glas 1x Preparation jig for fascie and cartilage, glass
20-610-15	1x Reynolds Schere, stumpf-stumpf, gebogen, verjüngte Spitze, 16 cm 1x Reynolds scissors, blunt-blunt, curved, tapered tips, 16 cm	10-700-05	1x Hartmann Ohrzängchen, gerieft, gerade, extrafein 1x Hartmann ear forceps, serrated, straight, extra delicate
10-534-12	1x Supercut Schere für Fascie, spitz-spitz, gebogen, 11,5 cm, extrafein 1x Supercut scissors for fascie, pointed, curved, 11.5 cm, extra delicate	10-703-00	1x Mikro-Ohrzängchen, ovale Löffel, gerade, fein 1x Micro ear forceps, oval curette, straight, delicate
10-482-14	1x Pinzette, anatomisch, 1,7 mm, 14,5 cm / Forceps, anatomical, 1.7 mm, 14.5 cm	10-705-00	1x Shea-Bellucci Ohrscherchen, gerade / Shea-Bellucci ear forceps, straight
10-485-14	1x Pinzette, chirurgisch, 1,4 mm, 14,5 cm / Forceps, surgical, 1.4 mm, 14.5 cm	10-701-00	1x Mikro-Ohrzängchen, gerieft, gerade, fein, selbstschließend 1x Micro ear forceps, serrated, straight, delicate, self-closing
10-489-15	1x Helms Pinzette, anatomisch, 15 cm / Helms forceps, anatomical, 15 cm	10-709-01	1x Dieter Hammerkopfstanze, gerade, aufwärts schneidend, fein 1x Dieter malleus nipper, straight, upwards cutting, delicate
10-504-10	1x Hildmann Knorpel-Pinzette, gerade, 11 cm 1x Hildmann cartilage forceps, straight, 11 cm	10-711-01	1x McGee Drahtschließzängchen, gerade / McGee wire closing forceps, straight
10-200-01	1x Hartmann Ohrtrichter, Gr. 1 / Hartmann speculum, size 1	10-719-00	1x PTFE Schutzhülse für Ohrzängchen, 6 Stück/Box 1x PTFE cover for ear forceps, 6 pieces/box
10-200-02	1x Hartmann Ohrtrichter, Gr. 2 / Hartmann speculum, size 2	10-731-14	1x House Quetschzange, 11 x 14 mm / House pressure forceps, 11 x 14 mm
10-200-03	1x Hartmann Ohrtrichter, Gr. 3 / Hartmann speculum, size 3	10-481-14	1x Pinzette, anatomisch, 14,5 cm, 2 mm / Forceps, anatomical, 14.5 cm, 2 mm
10-200-04	1x Hartmann Ohrtrichter, Gr. 4 / Hartmann speculum, size 4	10-555-13	1x Halsey Nadelhalter, Hartmetall, 13 cm, fein 1x Halsey needle holder, tungsten carbide, 13 cm, delicate
10-466-13	1x Williger Wundhaken, 4-zinkig, scharf / Williger retractor, 4 prongs, sharp	10-550-13	1x Universalschere, 13 cm, spitz-stumpf, gebogen 1x Universal scissors, 13 cm, blunt / pointed, curved
10-355-08	1x Plester Gehörgangsraspatorium, 8 mm / Plester raspatory, 8 mm	80-100-16	1x Bipolare Pinzette, 16 cm, gerade, 0,5 mm 1x Bipolar forceps, 16 cm, straight, 0.5 mm
10-356-00	1x Wullstein Raspatorium, schmal (Schippchen) / Wullstein raspatory, slender	80-501-01	1x Metallschale B1, Ø 40 mm, Volumen 0,02 l, Höhe 19 mm 1x Metal bowl B1, 40 mm Ø, 20 ml, 19 mm height
10-261-10	1x Buck Ohrkürette, scharf, Gr. 0 / Buck ear curette, sharp, size 0	80-501-02	1x Metallschale B2, Ø 60 mm, Volumen 0,06 l, Höhe 39 mm 1x Metal bowl B2, 60 mm Ø, 60 ml, 39 mm height
10-261-02	1x Buck Ohrkürette, scharf, Gr. 2 / Buck ear curette, sharp, size 2	80-501-04	1x Metallschale B6, Ø 110 mm, Volumen 0,40 l, Höhe 55 mm 1x Metal bowl B6, 110 mm Ø, 400 ml, 55 mm height
30-105-06	1x Frazier Saugrohr, 6 Ch., konisch, tränenförmige Sogsteuerung, AL 80 mm 1x Frazier suction tube, 6 Fr., conical, tearform suction control, WL 80 mm	1710001-B	1x Silikonfolie Miltheis, blau, steril, 0,13 x 40 x 6 mm, 10 x 3 Stück 1x Silicone foil Miltheis, blue, sterile, 0.13 x 40 x 6 mm, 10 x 3 pieces
30-105-10	1x Frazier Saugrohr, 10 Ch., konisch, tränenförmige Sogsteuerung, AL 80 mm 1x Frazier suction tube, 10 Fr., conical, tearform suction control, WL 80 mm	80-600-00	1x Sterilisations-System "Instru-Safe" für Mikro-Ohr-Instrumentarium 1x Sterilizing & protection system "Instru-Safe" for micro ear surgery
10-321-20	1x Wullstein Silber-Saugrohr, zylindrisch, 2 mm, biegsam 1x Wullstein silver suction tube, cylindrical, 2 mm, bendable	80-318-50	1x Bipolares Anschlusskabel, 5 m, passend für Erbe/Storz 1x Bipolar connecting cable, 5 m, comp. w. Erbe/Storz
10-305-11	1x Wullstein Saughandgriff mit Unterbrecher, 10,5 cm 1x Wullstein suction handle with suction control, 10.5 cm		
10-308-08-05	1x House Nadelsauger, Luer, 0,8 mm / House suction cannula, Luer lock, 0.8 mm		
10-308-12-05	1x House Nadelsauger, Luer, 1,2 mm / House suction cannula, Luer lock, 1.2 mm		
10-308-15-05	1x House Nadelsauger, Luer, 1,5 mm / House suction cannula, Luer lock, 1.5 mm		
10-308-20-05	1x House Nadelsauger, Luer, 2,0 mm / House suction cannula, Luer lock, 2.0 mm		
10-665-00	1x Tisch Handgriff für Mikrolöffel / Tisch handle for micro curette		
10-665-04	1x Tisch Mikrolöffel, 15°, Gr. 1 / Tisch micro curette, 15°, size 1		
10-665-05	1x Tisch Mikrolöffel, 15°, Gr. 2 / Tisch micro curette, 15°, size 2		
10-665-06	1x Tisch Mikrolöffel, 15°, Gr. 3 / Tisch micro curette, 15°, size 3		
10-729-18	1x Seiffert Speichelgangsonde, Silber / Seiffert salivary duct probe, silver		
10-644-90	1x Plester Antrum-Häkchen, stumpf, 90°, 4 mm 1x Plester antrum hook, blunt, 90°, 4 mm	10-733-09	1x Präparierplatte aus Glas, eine Seite angeraut, 9,5 x 7 x 0,5-0,6 cm 1x Cutting block, glass, one side satin finished, 9.5 x 7 x 0.5-0.6 cm
10-648-12	1x Rosen Raspatorium, 1,2 x 12 mm / Rosen raspatory, 1.2 x 12 mm	10-747-00	1x Arkansas-Öl-Stein zum Schleifen von Instrumenten 1x Arkansas oil whetstone for sharpening instruments
10-610-12	1x Rosen Rundschnittemesser, 1,2 mm, 45° / Rosen round knife, 1.2 mm, 45°	80-661-14	1x Norm-Sterilisations-Container Boden geschlossen, 585x274x138 mm Maße mit Deckel: 585x278x155 mm 1x Norm sterilization container bottom closed, 585x274x138 mm, dimensions with fitted lid: 585x278x155 mm
10-610-18	1x Rosen Rundschnittemesser, 1,8 mm, 45° / Rosen round knife, 1.8 mm, 45°	80-662-00	1x Ventildeckel silber, für Container 80-661-14, 585x278 mm 1x Valve lid silver, for container 80-661-14, 585x278 mm
10-610-25	1x Rosen Rundschnittemesser, 2,5 mm, 45° / Rosen round knife, 2.5 mm, 45°	80-671-60	1x Edelstahl-Siebkorb Geflecht, Fallgriffe 485x255x70 mm 1x Stainless steel wire basket Geflecht, sliding handles, 485x255x70 mm
10-614-25	1x Plester Rundschnittemesser, oval, seitlich / Plester round knife, oval	80-681-07	1x Aluminium-Kennzeichnungs-Schild blau, 20 Zeichen, 56x17 mm 1x Aluminium tag blue, 20 letters, 56x17 mm
10-618-02	1x Wullstein Sichelmesser, leicht gebogen, sehr fein 1x Wullstein sickle knife, slightly curved, delicate		
10-625-02	2x Wullstein Mikronadel, sehr leicht gebogen, spitz 2x Wullstein micro needle, very slightly curved, pointed		
10-630-06	1x Wullstein Mikrohäkchen, 45°, 0,6 mm / Wullstein micro hook, 45°, 0.6 mm		
10-630-08	1x Wullstein Mikrohäkchen, 45°, 0,8 mm / Wullstein micro hook, 45°, 0.8 mm		
10-628-06	1x Wullstein Mikrohäkchen, 90°, 0,6 mm / Wullstein micro hook, 90°, 0.6 mm		
10-628-08	1x Wullstein Mikrohäkchen, 90°, 0,8 mm / Wullstein micro hook, 90°, 0.8 mm		
10-628-15	1x Wullstein Mikrohäkchen, 90°, 1,5 mm / Wullstein micro hook, 90°, 1.5 mm		

Ergänzung 10-900-99

Supplement 10-900-99

10-733-09	1x Präparierplatte aus Glas, eine Seite angeraut, 9,5 x 7 x 0,5-0,6 cm 1x Cutting block, glass, one side satin finished, 9.5 x 7 x 0.5-0.6 cm
10-747-00	1x Arkansas-Öl-Stein zum Schleifen von Instrumenten 1x Arkansas oil whetstone for sharpening instruments
80-661-14	1x Norm-Sterilisations-Container Boden geschlossen, 585x274x138 mm Maße mit Deckel: 585x278x155 mm 1x Norm sterilization container bottom closed, 585x274x138 mm, dimensions with fitted lid: 585x278x155 mm
80-662-00	1x Ventildeckel silber, für Container 80-661-14, 585x278 mm 1x Valve lid silver, for container 80-661-14, 585x278 mm
80-671-60	1x Edelstahl-Siebkorb Geflecht, Fallgriffe 485x255x70 mm 1x Stainless steel wire basket Geflecht, sliding handles, 485x255x70 mm
80-681-07	1x Aluminium-Kennzeichnungs-Schild blau, 20 Zeichen, 56x17 mm 1x Aluminium tag blue, 20 letters, 56x17 mm

Supplement for sales in EU (outside the EU only on request)



12 Parazentese-Set 10-901-00

Paracentesis Set 10-901-00

Bestehend aus / Consisting of:

10-200-01	1x Hartmann Ohrtrichter, Gr. 1 / Hartmann ear specula, size 1	10-305-11	1x Wullstein Saughandgriff mit Unterbrecher, 10,5 cm, Luer-Lock 1x Wullstein suction handle with interruptor, 10.5 cm, Luer lock
10-200-02	1x Hartmann Ohrtrichter, Gr. 2 / Hartmann ear specula, size 2	10-308-10-05	1x House Nadelsauger, Luer-Lock, 7 cm, 1,0 mm, 5 Stück 1x House suction cannula, Luer lock, 7 cm, 1.0 mm, 5 pieces
10-200-03	1x Hartmann Ohrtrichter, Gr. 3 / Hartmann ear specula, size 3	10-308-12-05	1x House Nadelsauger, Luer-Lock, 7 cm, 1,2 mm, 5 Stück 1x House suction cannula, Luer lock, 7 cm, 1.2 mm, 5 pieces
10-200-04	1x Hartmann Ohrtrichter, Gr. 4 / Hartmann ear specula, size 4	10-308-15-05	1x House Nadelsauger, Luer-Lock, 7 cm, 1,5 mm, 5 Stück 1x House suction cannula, Luer lock, 7 cm, 1.5 mm, 5 pieces
10-260-01	1x Buck Ohrkürette, stumpf, leicht gebogen, Gr. 1 1x Buck ear curette, blunt, slightly curved, size 1	10-308-20-05	1x House Nadelsauger, Luer-Lock, 7 cm, 2,0 mm, 5 Stück 1x House suction cannula, Luer lock, 7 cm, 2.0 mm, 5 pieces
10-618-01	1x Wullstein Sichelmesser, leicht gebogen, fein, 16 cm 1x Wullstein sickle knife, slightly curved, fine, 16 cm	10150	1x Titan-Paukenröhrchen, Typ Kragenknopf, 1,5 mm, 10 Stück/Box 1x Titanium ventilation tube, type collar-button, 1.5 mm, 10 pieces/box
10-700-00	1x Hartmann Ohrzängchen, gerieft, gerade, fein, 0,8 x 7,0 mm, 8 cm 1x Hartmann ear forceps, serrated, straight, fine, 0.8 x 7.0 mm, 8 cm	80-605-00	1x Systemkomponente "Instru-Safe" für Parazentese-Set zur Aufnahme von Ohrtrichtern, Ohrzängchen, Häkchen und Nadeln 1x System module "Instru-Safe" for myringotomy set, holds earspecula, forceps, knives and hooks
10-628-08	1x Wullstein Mikrohäkchen, 90°, 0,8 mm, 16 cm 1x Wullstein micro hook, 90°, 0.8 mm, 16 cm		
10-625-02	1x Wullstein Mikronadel, sehr leicht gebogen, spitz, 16 cm 1x Wullstein micro needle, very slightly curved, pointed, 16 cm		

12 Ohrmuschel-Set 10-905-00

Otoplasty Set 10-905-00

Bestehend aus / Consisting of:

10-360-03	1x Skalpellgriff Nr. 3, 12,5 cm / 1x Scalpel handle no. 3, 12.5 cm	80-350-02	6x Halsted-Mosquito-Klemme gebogen, anatomisch, 12,5 cm 6x Halsted-Mosquito artery forceps, curved, anatomical, 12.5 cm
10-533-12	1x Schere, gebogen, spitz-spitz, 11,5 cm / 1x Scissors, curved, pointed, 11.5 cm	80-360-14	1x Präparierklemme ohne Sperre, leicht gebogen, anat., 14,5 cm 1x Artery Forceps without ratchet, anatomical, slightly curved, 14.5 cm
20-601-14	1x Joseph Schere, spitz-spitz, gebogen, 14,5 cm 1x Joseph scissors, pointed, curved, 14.5 cm	80-365-14	1x Pean Arterienklemme gerade, anatomisch, fein, 14 cm 1x Pean artery forceps anatomical, fine, straight, 14 cm
10-543-12	1x Schere, gebogen, stumpf-stumpf, 11,5 cm / 1x Scissors, curved, blunt, 11.5 cm	80-392-11	6x Backhaus Tuchklemme, gebogen, scharf, 11 cm 6x Backhaus towel clamp, sharp, curved, 11 cm
80-448-15	1x Cooper Schere, gebogen, spitz-stumpf, 14,5 cm 1x Cooper scissors, curved, sharp/blunt, 14.5 cm	10-555-13	1x Halsey Nadelhalter, Hartmetall, fein, 13 cm 1x Halsey needle holder TC, delicate, 13 cm
10-502-10	1x Graefe Pinzette, chirurgisch, 1:2 Zähne, gerade, 0,7 mm, 10 cm 1x Graefe dressing forceps, 1:2 teeth, straight, 0.7 mm, 10 cm	80-123-16	1x Bipolare Pinzette, NON-STICK, kniegebogen, extra fein, Spitze 8 mm lang, 0,2 mm breit, Führungsstift, 16,5 cm 1x Bipolar forceps, NON-STICK, angled, extra fine, tip length 8 mm, 0.2 mm wide, guide pin, 16.5 cm
20-710-12	1x Adson-Brown Pinzette, 7:8 Zähne, 12,5 cm 1x Adson-Brown forceps, 7:8 teeth, 12.5 cm	80-318-50	1x Bipolares Anschlusskabel, 5 m, passend für Erbe/Storz/Wolf, geräteseitig 1x Bipolar connecting cable, 5 m, comp. w. Erbe/Storz/Wolf, unit-side
10-481-14	1x Pinzette, anatomisch, gerade, 2 mm, 14,5 cm 1x Dressing forceps, anatomical, straight, 2 mm, 14.5 cm		
10-484-14	1x Pinzette, chirurgisch, 1:2 Zähne, gerade, 1,7 mm, 14,5 cm 1x Dressing forceps, surgical, 1:2 teeth, straight, 1.7 mm, 14.5 cm		
10-206-13-05	1x Watteträger, dreikant, gerieft, 0,9 mm Ø, 13 cm, 5 Stück/Box 1x Cotton carrier, triangular, serrated, 0.9 mm Ø, 13 cm, 5 pieces/box		
20-500-13	1x Cottle Septum-Messer, 14 cm / 1x Cottle septum knife, 14 cm		
20-305-18	1x Freer Doppelevatorium, scharf/stumpf, 18,5 cm 1x Freer elevator, double ended, sharp/blunt, 18.5 cm		
20-311-20	1x Freer-Joseph Doppel-Raspatorium, 20 cm 1x Freer-Joseph raspatorium, double-ended, 20 cm		
10-356-00	1x Wullstein Raspatorium, 4 mm breit, 16,5 cm 1x Wullstein raspatorium, 4 mm wide, 16.5 cm		
20-577-16	1x Cottle Hauthäkchen, 1-zinkig, gebogen, scharf, 14,5 cm 1x Cottle skin hook, 1-zinkig, curved, sharp, 14.5 cm		
20-582-05	1x Joseph Doppel-Häkchen, 2-zinkig, scharf, 6 mm, 16 cm 1x Joseph double hook, 2 prongs, sharp, 6 mm, 16 cm		
20-584-17	1x Fomon Nasenflügelhaken, 2-zinkig, stumpf, 12 mm, 16 cm 1x Fomon ala hook, 2 prongs, blunt, 12 mm, 16 cm		
80-503-03	1x Medizinbecher Edelstahl, graduert, Ø 50 mm, 30 ml 1x Medicine cup, stainless steel, graduated, Ø 50 mm, 30 ml		
40-553-01	1x Injektionskanüle, gerade, 0,8 mm, 12 cm, Luer-Lock 1x Injection cannula straight, 0.8 mm, 12 cm, Luer-lock		
30-080-08	1x Frazier Saugrohr mit Griffplatte und Unterbrecher, 8 Ch., 9 cm 1x Frazier suction tube with suction control, 8 Fr., 9 cm		
30-080-10	1x Frazier Saugrohr mit Griffplatte und Unterbrecher, 10 Ch., 9 cm 1x Frazier suction tube with suction control, 10 Fr., 9 cm		

Ergänzung 10-905-99

Supplement 10-905-99

10-360-11	1x Skalpell-Klingen, Nr. 11, 100 Stück / 1x Scalpel blades, no. 11, 100 pieces
10-360-15	1x Skalpell-Klingen, Nr. 15, 100 Stück / 1x Scalpel blades, no. 15, 100 pieces
80-631-14	1x Norm-Sterilisations-Container Boden geschlossen, 297x274x138 mm Maße mit Deckel: 299x278x155 mm 1x Norm sterilization container bottom closed, 297x274x138 mm, dimensions with fitted lid: 299x278x155 mm
80-632-00	1x Ventildeckel, silber, für Container 80-631-14, 299x278 mm 1x Valve lid, silver, for container 80-631-14, 299x278 mm
80-671-20	1x Edelstahl-Siebkorb, Geflecht, Fallgriffe, 255x245x50 mm 1x Stainless steel wire basket, sliding handles, 255x245x50 mm
80-681-06	1x Aluminium-Kennzeichnungs-Schild, lila, 20 Zeichen 1x Aluminium tag, purple, 20 letters

Supplement for sales in EU (outside the EU only on request)



12 Instrumenten-Set für Retroaurikuläre Ohr-Chirurgie 10-906-00

Retroauricular ear Set 10-906-00

Bestehend aus / Consisting of:

77HW001	1x Bohrhandstück 1,1, gewinkelt für Bohrer L. 70mm 1x Osteo-handpiece, 1,1, angled, for 70 mm burs	10-308-15-05	1x House suction cannula, Luer-Lock, 7 cm, 1,2 mm, 5 pieces/box 1x House Nadelsauger, Luer-Lock, 7 cm, 1,5 mm, 5 Stück/Box
BS23507034	1x Bohrerstander für 34 rotierende Instrumente der L 70 mm 1x Stand for 34 rotary instruments, length: 70 mm	10-308-20-05	1x House suction cannula, Luer-Lock, 7 cm, 1,5 mm, 5 pieces/box 1x House Nadelsauger, Luer-Lock, 7 cm, 2,0 mm, 5 Stück/Box
CR070010506	1x Osteotomie-Bohrer, HM, Ø 0,5 mm, 6 Schneiden 1x Osteotomy bur, TC, Ø 0,5 mm, 6 blades	10-648-12	1x House suction cannula, Luer-Lock, 7 cm, 2,0 mm, 5 pieces/box 1x Rosen Raspatorium, 1,0 x 12 mm, 16 cm
CR070010806	1x Osteotomie-Bohrer, HM, Ø 0,8 mm, 6 Schneiden 1x Osteotomy bur, TC, Ø 0,8 mm, 6 blades	10-610-18	1x Rosen raspatory, 1,0 x 12 mm, 16 cm 1x Rosen Rundsnittmesser, 45°, 1,8 mm, 16 cm
CR070011006	1x Osteotomie-Bohrer, HM, Ø 1,0 mm, 6 Schneiden 1x Osteotomy bur, TC, Ø 1,0 mm, 6 blades	10-610-25	1x Rosen round knife, 45°, 1,8 mm, 16 cm 1x Rosen Rundsnittmesser, 45°, 2,5 mm, 16 cm
CR070011206	1x Osteotomie-Bohrer, HM, Ø 1,2 mm, 6 Schneiden 1x Osteotomy bur, TC, Ø 1,2 mm, 6 blades	10-614-25	1x Rosen round knife, 45°, 2,5 mm, 16 cm 1x Plester Rundsnittmesser, vertikal, oval, 3,5 x 2,5 mm, 16 cm
CR070011406	1x Osteotomie-Bohrer, HM, Ø 1,4 mm, 6 Schneiden 1x Osteotomy bur, TC, Ø 1,4 mm, 6 blades	10-625-02	1x Plester flap knife, vertical, oval, 3,5 x 2,5 mm, 16 cm 1x Wullstein Mikronadel, sehr leicht gebogen, spitz, 16 cm
CR070011606	1x Osteotomie-Bohrer, HM, Ø 1,6 mm, 6 Schneiden 1x Osteotomy bur, TC, Ø 1,6 mm, 6 blades	10-630-08	1x Wullstein micro needle, very slightly curved, pointed, 16 cm 1x Wullstein Mikrohäkchen, 45°, 0,8 mm, 16 cm
CR070011806	1x Osteotomie-Bohrer, HM, Ø 1,8 mm, 6 Schneiden 1x Osteotomy bur, TC, Ø 1,8 mm, 6 blades	10-628-08	1x Wullstein micro hook, 45°, 0,8 mm, 16 cm 1x Wullstein Mikrohäkchen, 90°, 0,8 mm, 16 cm
CR070012106	1x Osteotomie-Bohrer, HM, Ø 2,1 mm, 6 Schneiden 1x Osteotomy bur, TC, Ø 2,1 mm, 6 blades	10-628-15	1x Wullstein micro hook, 90°, 0,8 mm, 16 cm 1x Wullstein Mikrohäkchen, 90°, 1,5 mm, 16 cm
CR070012708	1x Osteotomie-Bohrer, HM, Ø 2,7 mm, 8 Schneiden 1x Osteotomy bur, TC, Ø 2,7 mm, 8 blades	10-701-00	1x Wullstein micro hook, 90°, 1,5 mm, 16 cm 1x Hartmann Ohrzangchen, gerieft, gerade, fein, 0,8 x 4,0 mm, 8 cm
CR070013508	1x Osteotomie-Bohrer, HM, Ø 3,5 mm, 8 Schneiden 1x Osteotomy bur, TC, Ø 3,5 mm, 8 blades	10-703-00	1x Hartmann ear forceps, serrated, fine, straight, 0,8 x 4,0 mm, 8 cm 1x Mikro Ohrzangchen, ovale Löffel, gerade, fein, 0,8 x 1,3 mm, 8 cm
CR070014510	1x Osteotomie-Bohrer, HM, Ø 4,5 mm, 10 Schneiden 1x Osteotomy bur, TC, Ø 4,5 mm, 10 blades	10-705-00	1x Micro ear forceps, oval cups, straight, fine, 0,8 x 1,3 mm, 8 cm 1x Shea-Bellucci Ohrscheren, gerade, 8 mm, 8 cm
CR070015012	1x Osteotomie-Bohrer, HM, Ø 5,0 mm, 12 Schneiden 1x Osteotomy bur, TC, Ø 5,0 mm, 12 blades	10-719-00	1x Shea-Bellucci ear scissors, straight, 8 mm, 8 cm 3x PTFE-Schutzhülse mit Fenster, für Ohrzangchen, 11,5 cm, autokl., 10 Stk.
CR070016014	1x Osteotomie-Bohrer, HM, Ø 6,0 mm, 14 Schneiden 1x Osteotomy bur, TC, Ø 6,0 mm, 14 blades	10-731-14	3x PTFE-protecting sleeve for ear forceps, 11,5 cm, 10 pieces/box 1x House Quetsch-Zange, 11 x 14 mm, 18 cm
CR070017016	1x Osteotomie-Bohrer, HM, Ø 7,0 mm, 16 Schneiden 1x Osteotomy bur, TC, Ø 7,0 mm, 16 blades	10-481-14	1x House pressure forceps, 11 x 14 mm, 18 cm 1x Pinzette, anatomisch, gerade, 2 mm, 14,5 cm
DR070010691	1x Diamant-Bohrer, mittlere Körnung, Ø 0,6 mm 1x Diamond bur, medium grain, Ø 0,6 mm	10-555-13	1x Dressing forceps, anatomical, straight, 2 mm, 14,5 cm 1x Halsey Nadelhalter, Hartmetall, fein, 13 cm
DR070010791	1x Diamant-Bohrer, mittlere Körnung, Ø 0,7 mm 1x Diamond bur, medium grain, Ø 0,7 mm	10-550-13	1x Halsey needle holder, TC, delicate, 13 cm 1x Universalschere, gebogen, spitz-stumpf, 13 cm
DR070010891	1x Diamant-Bohrer, mittlere Körnung, Ø 0,8 mm 1x Diamond bur, medium grain, Ø 0,8 mm	80-123-16	1x Universal scissors, curved, blunt-sharp, 13 cm 1x Bipolare Pinzette, NON-STICK, kniegebogen, extra fein, 0,2 mm, 16,5 cm
DR070011291	1x Diamant-Bohrer, mittlere Körnung, Ø 1,2 mm 1x Diamond bur, medium grain, Ø 1,2 mm	80-318-50	1x Bipolar forceps, NON-STICK, angled, extra fine, 0,2 mm, 16,5 cm 1x Bipolares Anschlusskabel, 5 m, passend für Erbe/Storz/Wolf, geräteseitig
DR070011691	1x Diamant-Bohrer, mittlere Körnung, Ø 1,6 mm 1x Diamond bur, medium grain, Ø 1,6 mm	80-501-01	1x Bipolar connecting cable, 5 m, comp. w. Erbe/Storz/Wolf, unit-side 1x Metallschale B1, Ø 40 mm, Volumen 0,02 l, Höhe 19 mm
DR070012191	1x Diamant-Bohrer, mittlere Körnung, Ø 2,1 mm 1x Diamond bur, medium grain, Ø 2,1 mm	80-501-02	1x Metal bowl B1, 40 mm Ø, height 19 mm, 20 ml 1x Metallschale B2, Ø 60 mm, Volumen 0,06 l, Höhe 29 mm
DR070012591	1x Diamant-Bohrer, mittlere Körnung, Ø 2,5 mm 1x Diamond bur, medium grain, Ø 2,5 mm	80-501-04	1x Metal bowl B2, 60 mm Ø, height 29 mm, 60 ml 1x Metallschale B4, Ø 110 mm, Volumen 0,4 l, Höhe 55 mm
DR070012991	1x Diamant-Bohrer, mittlere Körnung, Ø 2,9 mm 1x Diamond bur, medium grain, Ø 2,9 mm	80-392-09	1x Metal bowl B4, 110 mm Ø, height 55 mm, 400 ml 1x Backhaus Tuchklemme, gebogen, scharf, 9 cm
DR070013591	1x Diamant-Bohrer, mittlere Körnung, Ø 3,5 mm 1x Diamond bur, medium grain, Ø 3,5 mm	80-350-02	1x Backhaus towel clamp, sharp, curved, 9 cm 1x Halsted-Mosquito-Klemme, gebogen, anatomisch, 12,5 cm
DR070014591	1x Diamant-Bohrer, mittlere Körnung, Ø 4,5 mm 1x Diamond bur, medium grain, Ø 4,5 mm		1x Halsted-Mosquito artery forceps, curved, anatomical, 12,5 cm
DR070016091	1x Diamant-Bohrer, mittlere Körnung, Ø 6,0 mm 1x Diamond bur, medium grain, Ø 6,0 mm		
DR070017091	1x Diamant-Bohrer, mittlere Körnung, Ø 7,0 mm 1x Diamond bur, medium grain, Ø 7,0 mm		
SR070095012	1x Osteotomie-Bohrer, rostfr. Stahl, Omni E, Ø 5,0 mm, 12 Schn., Knospe 1x Osteotomy bur, stainless steel, Omni E, Ø 5,0 mm, 12 bl., bud shape		
10-420-11	2x Wullstein Wundsperrer, 3:3 Zähne, halbscharf, 11 cm 2x Wullstein retractor, 3:3 prongs, semi-sharp, 11 cm		
10-438-17	1x Fisch Wundsperrer mit Gelenken, 3:3 Zähne, halbscharf, 16,5 cm 1x Fisch retractor, with joint, 3:3 prongs, semi-sharp, 16,5 cm		
20-601-14	1x Joseph Schere, spitz-spitz, gebogen, 14,5 cm 1x Joseph scissors, pointed, curved, 14,5 cm		
20-610-15	1x Reynolds Schere, stumpf-stumpf, gebogen, verjüngte Spitze, 16 cm 1x Reynolds scissors, blunt-blunt, tapered tips, curved, 16 cm		
10-482-14	1x Pinzette, anatomisch, gerade, 1,7 mm, 14,5 cm 1x Dressing forceps, anatomical, straight, 1,7 mm, 14,5 cm		
10-485-14	1x Pinzette, chirurgisch, 1:2 Zähne, gerade, 1,4 mm, 14,5 cm 1x Dressing forceps, surgical, 1:2 teeth, straight, 1,4 mm, 14,5 cm		
10-489-15	1x Helms Pinzette, anatomisch, gerade, 2,8 mm, 15 cm 1x Helms dressing forceps, surgical, straight, 2,8 mm, 15 cm		
10-504-10	1x Hildmann Knorpelpinzette, gerade, 11 cm 1x Hildmann cartilage forceps, straight, 11 cm		
10-466-13	1x Williger Wundhaken, 4 scharfe Zähne, 13,5 cm 1x Williger retractor, 4 sharp prongs, 13,5 cm		
10-355-08	1x Plester Gehörgangsraspatorium, flach gebogen, 8 mm, 18 cm 1x Plester raspatory, curved, 8 mm, 18 cm		
10-356-00	1x Wullstein Raspatorium, 4 mm, 16,5 cm 1x Wullstein raspatory, 4 mm, 16,5 cm		
10-261-10	1x Buck Ohrkürette, scharf, leicht gebogen, Gr. 0, 2,0 mm, 16 cm 1x Buck ear curette, sharp, slightly curved, size 0, 2,0 mm, 16 cm		
10-261-02	1x Buck Ohrkürette, scharf, leicht gebogen, Gr. 2, 3,0 mm, 16 cm 1x Buck ear curette, sharp, slightly curved, size 2, 3,0 mm, 16 cm		
10-305-11	1x Wullstein Saughandgriff mit Unterbrecher, 10,5 cm 1x Wullstein suction handle with suction control, 10,5 cm		
10-308-08-05	1x House Nadelsauger, Luer-Lock, 7 cm, 0,8 mm, 5 Stück/Box 1x House suction cannula, Luer-Lock, 7 cm, 0,8 mm, 5 pieces/box		
10-308-12-05	1x House Nadelsauger, Luer-Lock, 7 cm, 1,2 mm, 5 Stück/Box 1x House suction cannula, Luer-Lock, 7 cm, 1,2 mm, 5 pieces/box		

Ergänzung 10-906-99

Supplement 10-906-99

10-733-09	1x Präparierplatte aus Glas, eine Seite angeraut, 9,5 x 7 x 0,5-0,6 cm 1x Cutting block, glas, one side satin finished, 9,5 x 7 x 0,5-0,6 cm
10-747-00	1x Arkansas Ölstein, keilförmig, 90 x 40 mm 1x Arkansas oil whet stone, wedge-shaped, 90 x 40 mm
80-661-14	1x Norm-Sterilisations-Container, Boden geschlossen, 585 x 274 x 138 mm 1x Norm sterilization container, bottom closed, 585 x 274 x 138 mm
80-662-00	1x Ventildeckel, silber, für Container 80-661-14, 585 x 278 mm 1x Valve lid, silver, for container 80-661-14, 585 x 278 mm
80-671-60	1x Edelstahl-Siebkorb, Geflecht, Fallgriffe, 485 x 255 x 70 mm 1x Stainless steel wire basket, sliding handles, 485 x 255 x 70 mm
80-681-05	1x Aluminium-Kennzeichnungs-Schild, gelb, 20 Zeichen 1x Aluminium tag, yellow, 20 letters

Supplement for sales in EU (outside the EU only on request)

Bohrerlänge: 70 mm
Bur length: 70 mm



12 Tympanoplastik-Set 10-909-00

Tympanoplasty Set 10-909-00

Bestehend aus / Consisting of:

10-450-11	2x Wullstein Wundsperrer, 3:3 Zähne, 11 cm 2x Wullstein retractor, 3:3 prongs, 11 cm	10-610-25	1x Rosen Rundschnitmesser, 2,5 mm, 45°, 16 cm 1x Rosen round knife, 2.5 mm, 45°, 16 cm
10-458-11	1x Helms Wundsperrer, 2 Zähne rechts, Blatt mit Noppen links, 11 cm 1x Helms retractor, 2 prongs right, blade with studs, 11 cm	10-614-25	1x Plester Rundschnitmesser, oval, vertikal, 16 cm 1x Plester round knife, oval, vertical, 16 cm
10-459-11	1x Helms Wundsperrer, 2 Zähne links, Blatt mit Noppen rechts, 11,5 cm 1x Helms retractor, 2 prongs left, blade with studs right, 11.5 cm	10-618-02	1x Wullstein Sichelmesser, leicht gebogen, sehr fein, 16 cm 1x Wullstein sickle knife, slightly curved, delicate, 16 cm
10-468-17	1x Fisch Wundsperrer mit Gelenken, 3:3 Zähne, halbscharf, 16,5 cm 1x Fisch retractor, adjustable, 3:3 prongs, semi-sharp, 16.5 cm	10-625-02	2x Wullstein Mikronadel, sehr leicht gebogen, spitz, 16 cm 2x Wullstein micro needle, very slightly curved, pointed, 16 cm
20-100-01	1x Hartmann Nasenspekulum, zerlegbar, für Erwachsene 1x Hartmann nose specula, dismantable, for adults	10-627-02	1x Wullstein Mikrohäkchen "Color line", 45°, 0,2 mm, 16 cm 1x Wullstein micro hook "Color line", 45°, 0.2 mm, 16 cm
20-601-14	1x Joseph Schere, spitz-spitz, gebogen, 14,5 cm 1x Joseph scissors, pointed, curved, 14.5 cm	10-627-04	1x Wullstein Mikrohäkchen "Color line", 45°, 0,4 mm, 16 cm 1x Wullstein micro hook "Color line", 45°, 0.4 mm, 16 cm
20-610-15	1x Reynolds Schere, stumpf-stumpf, gebogen, verjüngte Spitze, 16 cm 1x Reynolds scissors, blunt, curved, tapered tips, 16 cm	10-627-06	1x Wullstein Mikrohäkchen "Color line", 45°, 0,6 mm, 16 cm 1x Wullstein micro hook "Color line", 45°, 0.6 mm, 16 cm
10-534-12	1x Supercut Schere für Fascie, spitz-spitz, gebogen, 11,5 cm, extrafein 1x Supercut scissors for fascie, pointed, curved, 11.5 cm, extra delicate	10-626-06	1x Wullstein Mikrohäkchen "Color line", 90°, 0,6 mm, 16 cm 1x Wullstein micro hook "Color line", 90°, 0.6 mm, 16 cm
10-482-14	1x Pinzette, anatomisch, gerade, 1,7 mm, 14,5 cm 1x Forceps, anatomical, straight, 1.7 mm, 14.5 cm	10-626-08	1x Wullstein Mikrohäkchen "Color line", 90°, 0,8 mm, 16 cm 1x Wullstein micro hook "Color line", 90°, 0.8 mm, 16 cm
10-485-14	1x Pinzette, chirurgisch, 1:2 Zähne, gerade, 1,4 mm, 14,5 cm 1x Forceps, 1:2 teeth, straight, 1.4 mm, 14.5 cm	10-626-10	1x Wullstein Mikrohäkchen, "Color line" 90°, 1,0 mm, 16 cm 1x Wullstein micro hook "Color line", 90°, 1.0 mm, 16 cm
10-489-15	1x Helms Pinzette, anatomisch, gerade, 2,8 mm, 15 cm 1x Helms forceps, anatomical, straight, 2.8 mm, 15 cm	10-700-01	1x Hartmann Ohrzangchen, gerieft, fein, gerade, 8 cm 1x Hartmann ear forceps, serrated, delicate, straight, 8 cm
20-710-12	1x Adson Brown Pinzette, 7:8 Zähne, 12,5 cm 1x Adson Brown forceps, 7:8 teeth, 12.5 cm	10-703-00	1x Mikro-Ohrzangchen, ovale Löffel, gerade, fein, 8 cm 1x Micro Ear forceps, oval curette, straight, delicate, 8 cm
10-504-10	1x Hildmann Knorpelpinzette, gerade, 11 cm 1x Hildmann cartilage forceps, straight, 11 cm	10-705-01	1x Bellucci Ohr Schere, gerade, fein, 4,0 mm, 8 cm 1x Bellucci ear forceps, straight, delicate, 4.0 mm, 8 cm
10-200-01	1x Hartmann Ohrtrichter, Gr. 1 / Hartmann speculum, size 1	10-719-00	3x PTFE-Schutzhülse mit Fenster, für Ohrzangchen, 11,5 cm, autoklavierbar, 10 Stück/Box 3x PTFE-protecting sleeve with window, for ear forceps, 11.5 cm, autoclavable, 10 pieces/box
10-200-02	1x Hartmann Ohrtrichter, Gr. 2 / Hartmann speculum, size 2	10-555-13	1x Halsey Nadelhalter, Hartmetall, fein, 13 cm 1x Halsey needle holder, tungsten carbide, delicate, 13 cm
10-200-03	1x Hartmann Ohrtrichter, Gr. 3 / Hartmann speculum, size 3	10-550-13	1x Universalschere, spitz-stumpf, gebogen, 13 cm 1x Universal scissors, blunt / pointed, curved, 13 cm
10-200-04	1x Hartmann Ohrtrichter, Gr. 4 / Hartmann speculum, size 4	80-501-01	1x Metallschale B1, Ø 40 mm, Volumen 0,02 l, Höhe 19 mm 1x Metal bowl B1, 40 mm Ø, 20 ml, 19 mm height
10-466-13	1x Williger Wundhaken, 4-zinkig, scharf, 13,5 cm 1x Williger retractor, 4 prongs, sharp, 13.5 cm	80-501-02	1x Metallschale B2, Ø 60 mm, Volumen 0,06 l, Höhe 29 mm 1x Metal bowl B2, 60 mm Ø, 60 ml, 29 mm height
10-355-08	1x Plester Gehörgangraspatorium, 8 mm, 18 cm 1x Plester raspatory, 8 mm, 18 cm	80-501-04	1x Metallschale B4, Ø 110 mm, Volumen 0,40 l, Höhe 55 mm 1x Metal bowl B4, 110 mm Ø, 400 ml, 55 mm height
10-356-00	1x Wullstein Raspatorium, 4 mm, 16,5 cm 1x Wullstein raspatory, 4 mm, 16.5 cm	80-123-16	1x Bipolare Pinzette, NON-STICK, kniegebogen, extra fein, Spitze 8 mm lang, 0,2 mm breit, Führungsstift, 16,5 cm 1x Bipolar forceps, NON-STICK, angled, extra fine, tip length 8 mm, 0.2 mm wide, guide pin, 16.5 cm
10-261-10	1x Buck Ohrkürette, Gr. 0, scharf, leicht gebogen, 2,0 mm, 16 cm 1x Buck ear curette, size 0, sharp, slightly curved, 2.0 mm, 16 cm	80-318-50	1x Bipolares Anschlusskabel, 5 m, passend für Erbe/Storz/Wolf, geräteseitig 1x Bipolar connecting cable, 5 m, comp. w. Erbe/Storz/Wolf, unit-side
10-261-02	1x Buck Ohrkürette, Gr. 2, scharf, leicht gebogen, 3,0 mm, 16 cm 1x Buck ear curette, size 2, sharp, slightly curved, 3.0 mm, 16 cm		
30-105-06	1x Frazier Saugrohr, 6 Ch., konisch, tränenförmige Sogsteuerung, AL 80 mm 1x Frazier suction tube, 6 Fr., conical, tearform suction control, WL 80 mm		
30-105-10	1x Frazier Saugrohr, 10 Ch., konisch, tränenförmige Sogsteuerung, AL 80 mm 1x Frazier suction tube, 10 Fr., conical, tearform suction control, WL 80 mm		
10-305-11	1x Wullstein Saughandgriff mit Unterbrecher, 10,5 cm 1x Wullstein suction handle with suction control, 10.5 cm		
10-308-08-05	1x House Nadelsauger, Luer Lock, 0,8 mm, 5 Stück/Box 1x House suction cannula, Luer lock, 0.8 mm, 5 pieces/box		
10-308-12-05	1x House Nadelsauger, Luer Lock, 1,2 mm, 5 Stück/Box 1x House suction cannula, Luer lock, 1.2 mm, 5 pieces/box		
10-308-15-05	1x House Nadelsauger, Luer Lock, 1,5 mm, 5 Stück/Box 1x House suction cannula, Luer lock, 1.5 mm, 5 pieces/box		
10-308-20-05	1x House Nadelsauger, Luer Lock, 2,0 mm, 5 Stück/Box 1x House suction cannula, Luer lock, 2.0 mm, 5 pieces/box		
10-667-00	1x Doppellöffel nach House, Gr.0, leicht gebogen, 17 cm 1x House curette, double ended, size 0, slightly curved, 17 cm		
10-667-01	1x Doppellöffel nach House, Gr.1, leicht gebogen, 17 cm 1x House curette, double ended, size 1, slightly curved, 17 cm		
10-667-02	1x Doppellöffel nach House, Gr.2, leicht gebogen, 17 cm 1x House curette, double ended, size 2, slightly curved, 17 cm		
10-610-12	1x Rosen Rundschnitmesser, 1,2 mm, 45°, 16 cm 1x Rosen round knife, 1.2 mm, 45°, 16 cm		
10-610-18	1x Rosen Rundschnitmesser, 1,8 mm, 45°, 16 cm 1x Rosen round knife, 1.8 mm, 45°, 16 cm		

Ergänzung 10-909-99

Supplement 10-909-99

80-661-14	1x Norm-Sterilisations-Container, Boden geschlossen, 585 x 274 x 138 mm 1x Norm sterilization container, bottom closed, 585 x 274 x 138 mm
80-662-00	1x Ventildeckel, silber, für Container 80-661-14, 585 x 278 mm 1x Valve lid, silver, for container 80-661-14, 585 x 278 mm
80-671-60	1x Edelstahl-Siebkorb, Geflecht, Fallgriffe, 485 x 255 x 70 mm 1x Stainless steel wire basket, sliding handles, 485 x 255 x 70 mm
80-681-07	2x Aluminium-Kennzeichnungs-Schild, blau, 20 Zeichen 2x Aluminium tag, blue, 20 letters

Supplement for sales in EU (outside the EU only on request)



Alphabetisches Inhaltsverzeichnis

Adson Pinzetten.....	38 - 39	Hoffmann Ohrzängchen.....	21	Politzer Parazentesemesser.....	22
Adson-Brown Pinzette.....	38	Holmgren Ohrtrichter, spreizbar.....	16	Porzellanschälchen.....	80
Akkuladegerät und Stirnleuchtenhalter für INTERVIEW III.....	8	House Doppellöffel.....	54	Preyer Ambossgabel.....	55
Akustikusneurinom-Ringpinzette.....	40	House Nadelsauger.....	24	Preyer Dissektor.....	53
Arkansas Ölstein.....	77	House Quetsch-Zange.....	76	Präparierplatte aus Glas.....	75
Aluminium-Kennzeichnungs-Schild.....	81	House Saug- und Spülrohr.....	26	Präparier-Tablett aus Edelstahl.....	72
Ambossgabel.....	55	House Saughandgriff.....	23	Reynolds Schere.....	44
Attik Watteträger.....	17	House-Bellucci Ohrscheren.....	68	Rosen Lanzettmesser.....	46
Austin Dissektor.....	52	Indikator-Klebe-etikett.....	81	Rosen Raspatorium.....	46
Baron Saugrohr.....	24	Instrumentenboxen.....	81 - 85	Rosen Rundschnittmesser.....	46
Beales Elevatorium.....	54	Instrumentenset für Retroaurikuläre Ohrchirurgie.....	91	Saugrohre.....	23 - 26
Bellucci Ohrscheren.....	68	Jobson Watteträger.....	19	Saxby Spülinstrument.....	61
Beyer Knochenzange.....	31	Joseph Schere.....	43	Scheren.....	42 - 45
Billeau Ohrschlinge.....	18	Kabierske Ersatzglas.....	12	Schlingen für Krause Ohrpolypenschnürer.....	22
Binokularlupe.....	9	Kabierske Kanülen.....	12	Schlingenführer für Krause Ohrpolypenschnürer.....	22
Bipolare Ringpinzette.....	40	Kabierske Pulverbläser.....	12	Schneidblock für PTFE Stapesprothesen.....	73
Blessing Nystagmusbrille.....	9	Kabierske Ventilball.....	12	Schuknecht Drahtbiegegerät.....	73
Brünings anastigmatische Ohrlupe.....	13	Kerrison Knochenstanze.....	31	Schuknecht Drahtschneidescherchen.....	45
Brünings Gummiball.....	13	Klemmschild aus Edelstahl.....	81	Schuknecht Mikrohäkchen / Mikronadel.....	51
Brünings Lupe.....	14	Kombi-Tasche.....	8	Schuknecht-Fisch Wundsperrerr.....	33
Brünings Ohrtrichter.....	14	Kornzangen-Behälter, Edelstahl / Glas.....	80	Schuknecht Saugrohr.....	24
Buck Ohrkürette.....	18	Krause Ohrpolypenschnürer.....	22	Semken Pinzette.....	38
Caversaccio Tympano Sizer.....	50	Kürzzängchen für Mittelohr-Implantate.....	70	Shambough-Derlacki Duckbill-Raspatorium.....	28
Citelli Knochenstanze.....	31	Langenbeck Raspatorium.....	27	Shea Venenpresse.....	76
Cooper Schere.....	45	LED-Leuchtgriffe.....	6	Siebkorb.....	81
Cottle Hammer.....	29	Lempert Knochenzange.....	30	Skalpelli-Griff / -Klingen.....	28
Cottle Raspatorium.....	27	Lempert Mastoid-Löffel.....	30	Snellen Ohrschlinge.....	19
Dauergebrauchs-Ohrtrichter.....	10	Lempert Raspatorium.....	27	Spencer Drahtschneideschere.....	45
Day Cerumenhäkchen.....	18	Lösungsschale.....	79	Spratt Mastoid-Löffel.....	30
Dazert Wundsperrerr.....	36	Lucae Cerumenhäkchen.....	17	Spritzschutz für Stirnlampe.....	7
DeBakey Pinzette.....	37	Lucae Ohrpinzette.....	19	Stapes Längen-Mess-Instrumente.....	71
Derlacki Gehörknöchelchen-Pinzette.....	39	Lucae Parazentesemesser.....	22	Stapesgelenk-Messer.....	47
Diamantbohrer.....	32	Lucae Stimmgabeln mit Fuß.....	13	Sterilisations-System "Instru-Safe".....	85
Dieter Hammerkopfstanze.....	69	Luer Knochenzange.....	30	Stimmgabeln.....	13
Drahtbiege- und Schneideschere.....	77	McGee Drahtschließzängchen.....	69	Stirnlampe, Stirnleuchte.....	7 - 8
Duckbill Ohrzängchen.....	21	McIndoe Pinzette.....	37	Stirnlampen-Ladestation.....	7
Einführpinzette.....	41	Medizinbecher.....	79	Stirnreifen.....	7 - 8
Einführungszängchen für Paukenröhrchen.....	78	Mess- und Kürzinstrumente für Mittelohrprothesen.....	71 - 73	Strümpel Ohrzängchen.....	22
Einmal-Ohrtrichter.....	11	Metallhammer.....	29	Tablettenschale.....	79
Einweg-Container-Siegel.....	81	Metallschale.....	79	PTFE-Schutzhülse für Ohrzängchen.....	73
Endoskophalter.....	77	Metallständer für Ohrtrichter.....	15	Teschner Sichelmesser.....	47
Endoskopie-Siebkorb.....	82	Metallständer für Ohrzängchen.....	74	Tilley Ohrtamponadezängchen.....	19
Endo- / Mikroskopische Instrumente nach Panetti.....	58 - 64	Metzenbaum Scheren.....	44	Tisch Mikrolöffel.....	55
Ersatzspekulum.....	5	Mikrolöffel.....	54 - 55	Titaninstrumente.....	56 - 57
Farabœuf Periost Raspatorium.....	27	Mikro-Ohrzängchen.....	63, 67	Toynbee Ohrtrichter.....	16
Farrior Ohrtrichter.....	15	Mikro-Häkchen, Titan.....	57	Trautmann Flachmeißel.....	29
Felsenbeinhalter Modell Würzburg.....	78	Mikro-Nadel, Titan.....	57	Trautmann Hohlmeißel.....	28
Fiber Otopskop beta 200.....	10	Mikro-Pinzette, Titan.....	57	Troeltsch Ohrpinzette.....	20
Fisch Crurotomie Scherchen.....	69	Mikro-Ritz-Instrument.....	54	T-Tube Einführungsinstrument.....	78
Fisch Dissektor.....	52 - 53	Mini-Otopskop 3000.....	9	Tympanoplastik / Stapesplastik-Set.....	89
Fisch Fußplatten-Perforator.....	53	Modul "Baron Saugrohre".....	83	Uhrmacherpinzetten.....	41
Fisch Referenz-Instrument für Stapes-Prothesen.....	71	Modul "Häkchen/Messer".....	83	Universal-Einführungszängchen.....	78
Fisch Referenz-Zylinder für Stapes-Prothesen.....	71	Modul "Mikrosaugröhrchen".....	83	Universalschere.....	45
Fisch Ohrzängchen.....	66	Modul "Ohrtrichter".....	83	Ventildeckel für Norm-Sterilisations-Container.....	81
Fisch Schneide- und Präparierblock.....	72	Modul "Ohrzängchen".....	83	Verhoeven Saugrohr.....	25
Fisch Wundsperrerr.....	36	Mollison Wundsperrerr.....	35	Watteträger.....	17
Fisch-McGee Drahtschließzängchen.....	70	Müller Drahtschließzängchen.....	70	Weitlaner Wundsperrerr.....	35
Flexibler Spannarm.....	77	Müller Einführungsinstrument.....	55	Wigand endauraler Wundsperrerr.....	35
Frazier Saugrohr.....	25	Nierenschale, Edelstahl.....	80	Williger Elevatorium.....	75
Freer Doppellevatorium.....	28	Norm-Sterilisationscontainer.....	81	Williger Wundhaken.....	36
Frenzel Nystagmusbrille.....	9	Noppenmatte.....	84	Wullstein Mikrohäkchen, "Colour Line".....	48 - 49
Führungsrohr für Krause Ohrpolypenschnürer.....	22	Nylon-Ersatzbacken.....	29	Wullstein Mikronadel.....	47
Gehörgang-Endoskop.....	5	Ölspray.....	78	Wullstein Pinzette.....	39
Gehörgangskürette.....	18	Ohrkürette.....	18	Wullstein Raspatorium.....	27
Gehörgangs- und Nasenspekulum.....	14 - 16	Ohrmuschelset.....	90	Wullstein Saughandgriff.....	23
Gelenkkloben.....	77	Ohrspekulumhalter.....	77	Wullstein Sichelmesser.....	23, 47
Graefe Pinzetten.....	39	Ohr-Tamponade-Stopfer.....	19	Wullstein Wundsperrerr.....	33
Greven Drahtschließzängchen.....	70	Otopskop.....	5 - 6, 64	XHL Xenon Ersatzlampe.....	10
Gruber Ohrtrichter.....	16	Osteotomiebohrer.....	32	Zenner Fußplattenhäkchen.....	53
Hajek Metallhammer.....	29	Panetti Set für Endo- / Mikroskopische Instrumente.....	86 - 87	Zimmermann-Akustikusneurinom-Ringpinzetten.....	40
Halsted Mosquito-Klemme.....	74	Parazentese-Set.....	90	Zöllner Aufsatzsauger.....	24
Halsey Nadelhalter.....	45	Paukenspiegel.....	53	Zöllner Mikroustrumente.....	76
Hartmann Ohrtrichter.....	14	Perkins Wundsperrerr.....	34	Zöllner Ohrtrichter.....	16
Hartmann Ohrzängchen.....	20 - 21, 56, 65 - 66	Petrischale.....	79	Zöllner Saugrohr.....	23
Hartmann Stimmgabeln (einzeln, Set).....	13	Pinzetten.....	37 - 41		
Hartmann Tamponadezängchen.....	19	Pinzette nach Bishop-Harmon.....	41		
Hartmetall- und Stahlbohrer.....	32	Plester (Antrum-)Häkchen.....	52		
Heermann Hammer und Handgriff.....	75	Plester Einführungs-gabel.....	53		
Heermann Hohlmeißel.....	75	Plester Fußplattenhäkchen.....	53		
Heermann Mikrohäkchen.....	76	Plester Gehörgangsraspatorium.....	27		
Heermann Ohrzängchen.....	74	Plester Rundschnittmesser.....	46		
Helms Pinzette.....	37	Plester Saugrohr.....	26		
Helms Wundsperrerr.....	34	Plester Sichelmesser.....	47		
Hildmann Knorpelpinzette.....	41	Plester Wundsperrerr.....	33		
HNO-Spülkorb.....	85	Politzer Ohrlive.....	11		
Hochleistungs-Fiberglas-Lichtleitkabel.....	62	Politzer Ohrtrichter.....	16		

Acoustic neurinoma ring forceps.....	40	Headlight cover.....	7	Preyer dissector.....	53
Adhesive indicator label.....	81	Headlight (halogen / cordless).....	7 - 8	Preyer incus fork.....	55
Adson dressing forceps.....	38 - 39	Headlight transformer.....	7	PTFE protection sleeve for ear forceps.....	73
Adson-Brown forceps.....	38	Heermann ear forceps.....	74	Retroauricular ear set.....	91
Arkansas oil whetstone.....	77	Heermann gouge.....	75	Reynolds scissors.....	44
Austin dissector.....	52	Heermann mallet and handle.....	75	Rosen lancet knife.....	46
Atticus cotton carrier.....	17	Heermann micro hook.....	76	Rosen raspatory.....	46
Atticus mirror.....	53	Helms dressing forceps.....	37	Rosen round knife.....	46
Bag for headlight.....	8	Helms retractor.....	34	Rotation clamp.....	77
Baron suction tube.....	24	High definition fibre light cable.....	62	Saxby-Irrigator.....	61
Basket.....	81	Hildmann cartilage forceps.....	41	Scalpel blades and handle.....	28
Battery charger and headlight rest for ENTERTAIN III.....	8	Hoffmann ear forceps.....	21	Schuknecht micro hook / needle.....	51
Beales elevator.....	54	Holmgren ear specula, expandable.....	16	Schuknecht-Fisch retractor.....	33
Bellucci ear scissors.....	68	House-Bellucci scissors.....	68	Schuknecht suction tube.....	24
Beyer rongeur.....	31	House curette, double ended.....	54	Schuknecht wire bending die.....	73
Billeau ear loop.....	18	House pressure forceps.....	76	Schuknecht wire cutting scissors.....	45
Binocular loupe.....	9	House suction- and irrigation tube.....	26	Scissors.....	42 - 45
Bipolar ring forceps.....	40	House suction cannula.....	24	Semken dressing forceps.....	38
Blessing nystagmus spectacles.....	9	House suction handle.....	23	Shambough-Derlacki duckbill raspatory.....	28
Brünings anastigmatic aural magnifier.....	13	Incudostapedial joint knife.....	47	Shea vein press.....	76
Brünings ear specula.....	14	Incus fork.....	55	Shortening forceps for middle ear implants.....	70
Brünings loupe head.....	14	Insertion forceps.....	41	Snellen ear loop.....	19
Brünings rubber bulb.....	13	Instrument boxes.....	81 - 85	Solution bowl.....	79
Buck ear curette.....	18	Jeweller forceps.....	41	Spare speculum.....	5
Cannula for Krause ear polyp snare.....	22	Jobson cotton carrier.....	19	Spencer wire cutting scissors.....	45
Carbide and steel burs.....	32	Joseph scissors.....	43	Spratt mastoid curette.....	30
Caversaccio Tympano Sizer.....	50	Kabierske annula.....	12	Stapes reference instruments.....	71
China bowl.....	80	Kabierske powder blower.....	12	Sterilizing and protection set, "Instru-Safe".....	85
Citelli bone punch.....	31	Kabierske rubber ball.....	12	Strümpel ear forceps.....	22
Coding label.....	81	Kabierske spare bottle.....	12	Styler for Krause ear polyp snare.....	22
Container seal.....	81	Kerrison bone punch.....	31	Suction tubes.....	23 - 26
Cooper scissors.....	45	Kidney bowl.....	80	Tablet dish.....	79
Cottle mallet.....	29	Krause ear polyp snare.....	22	Temporal bone holder Würzburg type.....	78
Cottle raspatory.....	27	Label holder with clip.....	81	Teschner sickle knife.....	47
Cotton carrier.....	17	Langenbeck raspatory.....	27	Tilley dressing and sponge holding forceps.....	19
Cutting block (glass).....	75	LED light handles.....	6	Tisch micro curette.....	55
Curette.....	54 - 55	Lempert mastoid curette.....	30	Titanium micro needle / hook / forceps.....	56 - 57
Day cerumen hook.....	18	Lempert raspatory.....	27	Toynbee ear specula.....	16
Dazert retractor.....	36	Lempert rongeur.....	30	Trautmann chisel.....	29
DeBakey dressing forceps.....	37	Lucae cerumen hook.....	17	Trautmann gouge.....	28
Derlacki ossicle holding forceps.....	39	Lucae dressing forceps.....	19	Tray "Baron suction tubes".....	83
Diamond burs.....	32	Lucae myringotomy blade.....	22	Tray "Ear forceps".....	83
Dieter malleus nipper.....	69	Lucae tuning forks.....	13	Tray "Ear specula".....	83
Dressing forceps.....	37 - 41	Luer rongeur.....	30	Tray "Hooks and knives".....	83
Duckbill ear forceps.....	21	McGee wire closing forceps.....	69	Tray "Micro suction tubes".....	83
Ear canal and nasal specula.....	14 - 16	McIndoe dressing forceps.....	37	Troeltsch dressing forceps.....	20
Ear canal curette.....	18	Measuring instruments for middle ear prostheses.....	71 - 73	T-tube inserter.....	78
Ear canal endoscope.....	5	Medicine cup.....	79	Tuning forks.....	13
Ear curette.....	18	Metal bowl.....	79	Tympanoplasty / Stapesplasty Set.....	89
Endoscopic / Microscopic instruments by Panetti.....	58 - 64	Metal mallet with nylon facings.....	29	Universal scissors.....	45
Ear specula, disposable.....	11	Metal stand for ear forceps.....	74	Universal insertion forceps.....	78
Ear speculum clamp.....	77	Metal stand for ear specula.....	15	Valve lid for norm sterilization container.....	81
Endoscope clamp.....	77	Metzenbaum scissors.....	44	Ventilation tube insertion forceps.....	78
Endoscope container.....	82	Micro ear forceps.....	63, 67	Verhoeven suction tube.....	25
ENT instrument tray.....	85	Micro forceps, titanium.....	57	Weitlaner retractor.....	35
Farabouef Periost raspatory.....	27	Micro hook, titanium.....	57	Wigand endaural retractor.....	35
Farrion ear specula.....	15	Micro needle, titanium.....	57	Williger retractor.....	35
Fibre otoscope beta 200.....	10	Micro scratching instrument.....	54	Williger elevator.....	75
Fingermat.....	84	Mini otoscope 3000.....	9	Wire bending and cutting scissors.....	77
Fisch crurotomy scissors.....	69	Mollison retractor.....	35	Wire loops for Krause ear polyp snare.....	22
Fisch cutting and preparation jig.....	72	Multi use ear specula.....	10	Wullstein dressing forceps.....	39
Fisch dissector.....	52 - 53	Müller insertion fork for cochlea implants.....	55	Wullstein micro hook, "Colour Line".....	48 - 49
Fisch retractor.....	36	Müller wire closing forceps.....	70	Wullstein micro needle.....	47
Fisch ear forceps.....	66	Norm sterilisation container.....	81	Wullstein raspatory.....	27
Fisch footplate perforator.....	53	Nylon spare facings.....	29	Wullstein retractor.....	33
Fisch reference caliper for stapes prostheses.....	71	Oil spray.....	78	Wullstein sickle knife.....	23, 47
Fisch reference instrument for stapes prostheses.....	71	Osteotomy burs.....	32	Wullstein suction handle.....	23
Fisch-McGee wire closing forceps.....	70	Otoscope.....	5 - 6, 64	XHL xenon spare bulb.....	10
Flexible holding arm.....	77	Otoplasty set.....	90	Zenner footplate hook.....	53
Forceps by Bishop-Harmon.....	41	Panetti Endoscopic / Microscopic Instruments Set.....	86 - 87	Zimmermann acoustic neurinoma ring forceps.....	40
Forceps holder, stainless steel / glass.....	80	Paracensis Set.....	90	Zöllner ear specula.....	16
Frazier suction tube.....	25	Perkins retractor.....	34	Zöllner micro instruments.....	76
Freer double elevator.....	28	Petri dish.....	79	Zöllner suction tip.....	24
Frenzel nystagmus spectacles.....	9	Piston cutting jig.....	73	Zöllner suction tube.....	23
Gauze applicator.....	19	Plester (antrum) hook.....	52		
Graefe dressing forceps.....	39	Plester flap knife.....	46		
Greven wire closing forceps.....	70	Plester footplate hook.....	53		
Gruber ear speculum.....	16	Plester guiding fork for stapes prostheses.....	53		
Hajek metal mallet.....	29	Plester raspatory.....	27		
Halsey needle holder.....	45	Plester retractor.....	33		
Halsted mosquito clamp.....	74	Plester sickle knife.....	47		
Hartmann ear forceps.....	20 - 21, 56, 65-66	Plester suction tube.....	26		
Hartmann ear tampon forceps.....	19	Politzer ear specula for infants.....	16		
Hartmann ear specula.....	14	Politzer ear olive.....	11		
Hartmann tuning forks.....	13	Politzer myringotomy blade.....	22		
Headband.....	7 - 8	Preparation tray, stainless steel.....	72		



Numerisches Inhaltsverzeichnis

Numeric Content

41.....13	10-188-03.....15	10-269-02.....19	10-353-03.....27	10-498-15.....39
42.....13	10-188-04.....15	10-271-14.....19	10-353-04.....27	10-499-15.....39
43.....13	10-188-05.....15	10-272-01.....19	10-353-05.....27	10-500-10.....39
44.....13	10-188-06.....15	10-272-02.....19	10-353-07.....27	10-501-10.....39
45.....13	10-188-07.....15	10-273-01.....19	10-354-03.....27	10-502-10.....39
46.....13	10-188-08.....15	10-274-00.....20	10-355-08.....27	10-503-10.....39
00-108-005.....78	10-188-09.....15	10-274-01.....20	10-356-00.....27	10-504-10.....41
10-102-00.....5	10-190-00.....58	10-274-02.....20	10-356-01.....27	10-506-05.....41
10-102-30.....5	10-190-01.....15	10-274-03.....20	10-357-18.....28	10-506-10.....41
10-104-00.....5	10-190-02.....15	10-276-00.....20	10-358-15.....28	10-507-11.....41
10-104-30.....5	10-190-03.....15	10-276-01.....20	10-360-03.....28	10-507-14.....41
10-106-00.....5	10-190-04.....15	10-276-02.....65	10-360-04.....28	10-512-15.....41
10-107-30.....5	10-190-05.....15	10-277-00.....21	10-360-07.....28	10-530-10.....42
10-108-00.....5	10-190-06.....15	10-278-01.....21	10-360-10.....28	10-530-12.....42
10-108-99.....5	10-190-07.....15	10-278-02.....21	10-360-11.....28	10-531-12.....42
10-090-00.....5, 64	10-190-08.....15	10-278-03.....21	10-360-15.....28	10-532-12.....42
10-090-30.....5, 64	10-190-09.....15	10-278-04.....21	10-365-02.....28	10-533-10.....43
10-090-45.....5, 64	10-192-01.....16	10-279-00.....21	10-365-04.....28	10-533-12.....43
10-109-00.....5, 64	10-192-02.....16	10-279-01.....21	10-365-06.....28	10-534-12.....42
10-109-30.....5, 64	10-192-03.....16	10-279-45.....21	10-365-08.....28	10-535-12.....42
10-109-45.....5, 64	10-192-04.....16	10-280-00.....21	10-366-02.....29	10-536-10.....42
10-109-70.....5, 64	10-192-05.....16	10-281-00.....22	10-366-04.....29	10-540-12.....43
10-111-00.....6	10-192-06.....16	10-282-45.....22	10-366-06.....29	10-541-12.....43
10-111-30.....6	10-194-01.....16	10-282-90.....22	10-366-08.....29	10-542-12.....44
10-111-45.....6	10-194-02.....16	10-282-45.....22	10-405-01.....30	10-543-12.....43
10-111-70.....6	10-194-03.....16	10-282-90.....22	10-405-02.....30	10-544-12.....43
10-110-00.....7	10-195-01.....16	10-283-18.....22	10-405-03.....30	10-545-12.....44
10-110-03.....7	10-195-02.....16	10-283-98.....22	10-405-04.....30	10-549-10.....45
10-120-00.....7	10-195-03.....16	10-283-99.....22	10-405-10.....30	10-550-13.....45
10-120-01.....7	10-200-00.....14	10-284-00.....22	10-405-20.....30	10-552-11.....45
10-120-10.....7	10-200-01.....14	10-284-12.....22	10-405-30.....30	10-555-13.....45
10-120-99.....8	10-200-02.....14	10-290-16.....22	10-406-01.....30	10-556-13.....45
10-122-00.....7	10-200-03.....14	10-291-18.....22	10-406-10.....30	10-600-00.....57
10-140-00.....9	10-200-04.....14	10-300-10.....23	10-406-20.....30	10-601-00.....57
10-141-00.....9	10-201-01.....14	10-300-15.....23	10-406-30.....30	10-603-10.....57
10-141-01.....9	10-201-02.....14	10-300-20.....23	10-406-40.....30	10-604-10.....57
10-141-99.....9	10-202-01.....16	10-300-25.....23	10-408-15.....30	10-605-10.....57
10-142-00.....9	10-202-02.....16	10-300-30.....23	10-409-19.....30	10-609-02 TAN.....50
10-143-00.....9	10-202-03.....16	10-300-35.....23	10-410-19.....30	10-609-04 TAN.....50
10-143-99.....10	10-203-05.....16	10-300-40.....23	10-412-18.....31	10-609-06 TAN.....50
10-145-80.....10	10-203-06.....16	10-300-50.....23	10-415-02.....31	10-610-10.....46
10-145-01.....10	10-203-07.....16	10-302-30.....23	10-416-01.....31	10-610-12.....46
10-145-24.....10	10-204-99.....15	10-302-35.....23	10-416-02.....31	10-610-15.....46
10-145-30.....10	10-205-01.....17	10-302-45.....23	10-416-03.....31	10-610-18.....46
10-145-40.....10	10-205-02.....17	10-303-18.....23	10-420-11.....33	10-610-20.....46
10-145-50.....10	10-205-03.....17	10-305-11.....23	10-420-13.....33	10-610-23.....46
10-145-98.....10	10-205-04.....17	10-306-05.....23	10-420-16.....33	10-610-25.....46
10-145-99.....10	10-206-13-05.....17	10-308-06-05.....24	10-421-11.....33	10-610-30.....46
10-148-25.....11	10-208-00.....19	10-308-08-05.....24	10-422-11.....33	10-611-06.....46
10-148-40.....11	10-249-01.....17	10-308-10-05.....24	10-422-13.....33	10-611-10.....46
10-151-00.....11	10-249-02.....17	10-308-12-05.....24	10-423-13.....33	10-611-15.....46
10-151-02.....11	10-249-03.....17	10-308-15-05.....24	10-426-11.....33	10-611-20.....46
10-151-03.....11	10-249-04.....17	10-308-18-05.....24	10-426-13.....34	10-611-25.....46
10-151-15.....11	10-249-05.....17	10-308-20-05.....24	10-427-11.....33	10-612-10.....46
10-151-22.....11	10-250-01.....17	10-308-22-05.....24	10-427-13.....34	10-612-15.....46
10-155-00.....12	10-250-02.....17	10-308-25-05.....24	10-428-11.....34	10-612-20.....46
10-155-01.....12	10-250-03.....17	10-308-30-05.....24	10-429-11.....34	10-612-25.....46
10-155-02.....12	10-250-04.....17	10-309-06-05.....24	10-430-11.....35	10-612-30.....46
10-155-08.....12	10-251-01.....17	10-309-08-05.....24	10-431-11.....35	10-613-00.....46
10-155-11.....12	10-251-02.....17	10-309-10-05.....24	10-432-11.....34	10-614-25.....46
10-155-13.....12	10-251-03.....17	10-309-12-05.....24	10-432-13.....34	10-615-00.....46
10-158-01.....52	10-251-04.....17	10-310-07.....24	10-433-11.....34	10-616-00.....47
10-158-02.....52	10-251-05.....17	10-310-25.....23	10-433-13.....35	10-618-01.....23, 47
10-171-01.....13	10-252-01.....18	10-312-10.....24	10-434-11.....35	10-618-02.....47
10-172-00.....13	10-252-02.....18	10-312-17.....24	10-434-13.....35	10-618-03.....47
10-172-01.....13	10-258-00.....18	10-312-23.....24	10-435-15.....35	10-618-04.....47
10-172-02.....13	10-258-01.....18	10-313-12.....26	10-437-13.....35	10-619-00.....47
10-172-03.....13	10-258-02.....18	10-313-20.....26	10-438-17.....36	10-620-00.....47
10-172-04.....13	10-258-03.....18	10-313-23.....25	10-446-11.....36	10-625-01.....47
10-172-05.....13	10-259-00.....18	10-313-24.....25	10-447-11.....36	10-625-02.....47
10-179-00.....13	10-259-01.....18	10-314-13.....26	10-466-13.....36	10-625-03.....47
10-180-00.....13	10-259-02.....18	10-314-14.....25	10-467-13.....36	10-625-04.....47
10-182-01.....13	10-259-03.....18	10-314-15.....25	10-480-14.....37	10-625-12.....47
10-182-02.....14	10-260-01.....18	10-314-20.....24	10-481-14.....37	10-626-02.....49
10-182-04.....14	10-260-02.....18	10-314-22.....24	10-482-14.....37	10-626-04.....49
10-183-01.....14	10-260-03.....18	10-314-24.....24	10-483-14.....37	10-626-06.....49
10-183-02.....14	10-260-10.....18	10-315-15.....26	10-484-14.....37	10-626-08.....49
10-183-03.....14	10-260-20.....18	10-315-20.....26	10-485-14.....37	10-626-10.....49
10-183-04.....14	10-261-01.....18	10-315-25.....26	10-485-15.....37	10-627-02.....49
10-183-10.....14	10-261-02.....18	10-315-30.....26	10-486-16.....37	10-627-04.....49
10-186-01.....15	10-261-03.....18	10-318-14.....26	10-487-16.....37	10-627-06.....49
10-186-02.....15	10-261-10.....18	10-318-15.....26	10-488-15.....37	10-627-08.....49
10-186-03.....15	10-261-20.....18	10-318-23.....26	10-489-15.....37	10-627-10.....49
10-186-04.....15	10-263-01.....18	10-318-33.....26	10-490-16.....38	10-628-02.....48
10-186-05.....15	10-263-02.....18	10-318-45.....26	10-491-18.....38	10-628-04.....48
10-186-06.....15	10-263-03.....18	10-348-19.....27	10-492-12.....38	10-628-05.....48
10-186-07.....15	10-265-01.....19	10-350-13.....27	10-492-15.....38	10-628-06.....48
10-186-08.....15	10-265-02.....19	10-351-13.....27	10-494-12.....37	10-628-08.....48
10-186-09.....15	10-265-03.....19	10-352-08.....27	10-495-12.....37	10-628-10.....48
10-188-01.....15	10-268-18.....19	10-352-14.....27	10-496-12.....39	10-628-12.....48
10-188-02.....15	10-269-01.....19	10-353-02.....27	10-497-12.....39	10-628-15.....48



10-628-20.....	48	10-665-01.....	55	10-758-00.....	78	80-204-01.....	40
10-628-25.....	48	10-665-02.....	55	10-759-00.....	78	80-350-01.....	74
10-628-30.....	48	10-665-03.....	55	10-760-00.....	78	80-350-02.....	74
10-628-40.....	48	10-665-04.....	55	10-800-12.....	60	80-448-15.....	45
10-630-02.....	48	10-665-05.....	55	10-801-12.....	60	80-500-00.....	79
10-630-04.....	48	10-665-06.....	55	10-802-12.....	60	80-501-01.....	79
10-630-06.....	48	10-667-00.....	54	10-803-12.....	60	80-501-02.....	79
10-630-08.....	48	10-667-01.....	54	10-804-12.....	60	80-501-03.....	79
10-630-10.....	48	10-667-02.....	54	10-805-12.....	60	80-501-04.....	79
10-630-12.....	48	10-667-03.....	54	10-806-12.....	60	80-503-03.....	79
10-630-15.....	48	10-669-01.....	18	10-807-12.....	60	80-504-05.....	79
10-630-20.....	48	10-669-02.....	18	10-808-12.....	60	80-506-30.....	79
10-630-25.....	48	10-670-00.....	55	10-809-12.....	60	80-507-40.....	79
10-631-18.....	48	10-700-00.....	65	10-810-12.....	61	80-509-75.....	79
10-632-00.....	53	10-700-01.....	65	10-811-12.....	60	80-512-00.....	79
10-634-01.....	51	10-700-02.....	65	10-812-12.....	61	80-515-06.....	79
10-634-02.....	51	10-700-03.....	65	10-813-12.....	61	80-515-08.....	79
10-634-03.....	51	10-700-04.....	65	10-814-12.....	61	80-515-10.....	79
10-635-02.....	51	10-700-05.....	66	10-815-12.....	61	80-519-00.....	80
10-635-04.....	51	10-700-06.....	66	10-816-12.....	61	80-519-01.....	80
10-635-06.....	51	10-700-07.....	66	10-817-12.....	61	80-519-02.....	80
10-635-08.....	51	10-700-08.....	65	10-818-12.....	61	80-519-03.....	80
10-635-10.....	51	10-700-09.....	65	10-819-12.....	61	80-520-06.....	80
10-635-12.....	51	10-700-11.....	65	10-820-12.....	61	80-520-08.....	80
10-635-14.....	51	10-700-14.....	65	10-830-17.....	63	80-525-17.....	80
10-635-16.....	51	10-701-00.....	66	10-831-17.....	63	80-525-25.....	80
10-635-18.....	51	10-702-10.....	56	10-832-17.....	63	80-528-13.....	80
10-635-22.....	51	10-702-11.....	56	10-833-17.....	63	80-528-18.....	80
10-635-24.....	51	10-703-00.....	67	10-840-01.....	62	80-528-20.....	80
10-635-26.....	51	10-703-01.....	67	10-845-01.....	62	80-530-20.....	80
10-635-28.....	51	10-703-02.....	67	10-851-00.....	62	80-600-00.....	82
10-636-02.....	51	10-703-03.....	63, 67	10-867-12.....	60	80-601-01.....	83
10-636-04.....	51	10-703-04.....	63, 67	10-890-00.....	86	80-601-02.....	83
10-636-06.....	51	10-703-05.....	67	10-895-00.....	86	80-601-03.....	83
10-636-08.....	51	10-703-06.....	67	10-896-00.....	87	80-601-04.....	83
10-636-10.....	51	10-703-07.....	63, 67	10-900-00.....	89	80-601-05.....	83
10-637-02.....	52	10-703-10.....	56	10-901-00.....	90	80-601-08.....	84
10-637-04.....	52	10-705-00.....	68	10-905-00.....	90	80-602-30.....	84
10-637-06.....	52	10-705-01.....	68	10-906-00.....	91	80-602-32.....	84
10-637-08.....	52	10-705-02.....	68	10-908-00.....	88	80-603-01.....	84
10-637-10.....	52	10-705-03.....	68	10-909-00.....	92	80-603-02.....	84
10-637-62.....	52	10-705-04.....	68	15-712-08.....	20	80-603-03.....	85
10-638-02.....	52	10-705-05.....	68	20-100-01.....	14	80-603-04.....	85
10-638-04.....	52	10-705-06.....	68	20-305-18.....	28	80-605-00.....	85
10-638-06.....	52	10-705-08.....	68	20-400-18.....	29	80-631-10.....	81
10-638-08.....	52	10-705-09.....	68	20-401-18.....	29	80-631-12.....	81
10-638-10.....	52	10-706-01.....	68	20-401-99.....	29	80-631-14.....	81
10-639-01.....	76	10-706-02.....	68	20-402-21.....	29	80-631-21.....	81
10-639-02.....	76	10-706-03.....	68	20-404-20.....	29	80-632-00.....	81
10-639-03.....	76	10-706-04.....	68	20-600-14.....	43	80-632-01.....	81
10-639-04.....	76	10-708-01.....	69	20-601-14.....	43	80-632-02.....	81
10-639-05.....	76	10-708-02.....	69	20-602-14.....	43	80-632-03.....	81
10-639-06.....	76	10-709-01.....	69	20-603-14.....	43	80-632-04.....	81
10-639-07.....	76	10-709-02.....	69	20-610-15.....	44	80-632-05.....	81
10-640-00.....	52	10-711-01.....	69	20-612-14.....	44	80-641-14.....	81
10-642-02.....	53	10-711-02.....	69	20-612-15.....	44	80-642-00.....	81
10-642-04.....	53	10-711-03.....	69	20-613-15.....	44	80-642-01.....	81
10-642-06.....	53	10-712-00.....	70	20-614-15.....	44	80-642-02.....	81
10-644-45.....	52	10-713-00.....	70	20-615-15.....	44	80-642-03.....	81
10-644-90.....	52	10-714-00.....	70	20-647-12.....	45	80-642-04.....	81
10-647-00.....	53	10-715-00.....	70	20-648-12.....	45	80-642-05.....	81
10-648-12.....	54	10-716-00.....	74	20-710-12.....	38	80-661-12.....	81
10-649-18.....	54	10-716-02.....	74	20-711-12.....	38	80-661-14.....	81
10-650-00.....	71	10-716-03.....	74	20-712-12.....	38	80-661-21.....	81
10-651-00.....	71	10-718-00.....	74	30-080-05.....	25	80-662-00.....	81
10-652-00.....	71	10-719-00.....	73	30-080-06.....	25	80-662-01.....	81
10-653-01.....	71	10-720-21.....	75	30-080-07.....	25	80-662-02.....	81
10-653-02.....	71	10-722-13.....	75	30-080-08.....	25	80-662-03.....	81
10-655-01.....	52	10-723-09.....	75	30-080-09.....	25	80-662-04.....	81
10-655-02.....	52	10-726-10.....	75	30-080-10.....	25	80-662-05.....	81
10-656-01.....	53	10-726-15.....	75	30-080-12.....	25	80-671-20.....	81
10-656-02.....	53	10-726-30.....	75	30-080-15.....	25	80-671-25.....	81
10-657-01.....	53	10-727-01.....	76	30-105-06.....	25	80-671-40.....	81
10-657-02.....	53	10-727-02.....	76	30-105-08.....	25	80-671-60.....	81
10-658-03.....	53	10-727-03.....	76	30-105-10.....	25	80-681-01.....	81
10-658-04.....	53	10-727-04.....	76	30-700-00.....	77	80-681-02.....	81
10-658-05.....	53	10-730-16.....	76	30-700-01.....	77	80-681-03.....	81
10-658-06.....	53	10-730-30.....	76	70-211-00.....	6	80-681-04.....	81
10-658-08.....	53	10-731-14.....	76	70-211-01.....	6	80-681-05.....	81
10-659-04.....	71	10-731-30.....	76	70-211-10.....	6	80-681-06.....	81
10-659-06.....	71	10-733-09.....	75	70-211-20.....	6	80-681-07.....	81
10-659-08.....	71	10-735-00.....	72	70-211-30.....	6	80-683-10.....	81
10-660-00.....	55	10-738-04.....	72	70-211-40.....	6	80-684-10.....	81
10-662-30.....	53	10-738-06.....	72	70-211-50.....	6	80-688-00.....	81
10-663-01.....	54	10-740-01.....	73	70-266-02.....	62	80-690-01.....	82
10-664-00.....	54	10-742-00.....	73	70-267-03.....	62	80-690-02.....	82
10-664-01.....	54	10-745-12.....	77	80-201-01.....	40	80-691-01.....	82
10-664-02.....	54	10-747-00.....	77	80-201-02.....	40	80-692-01.....	82
10-664-03.....	54	10-750-00.....	77	80-201-03.....	40	80-695-00.....	85
10-664-04.....	54	10-751-00.....	77	80-202-01.....	40	80-697-00.....	85
10-665-00.....	55	10-755-00.....	78	80-202-02.....	40		



Umrechnungstabelle - Ch/Fr - mm - inch

Conversion table - Ch/Fr - mm - inch

Charrière (CH) French (F)	mm	Inch
1	0,33	0,013
2	0,67	0,025
3	1,00	0,039
4	1,33	0,051
5	1,67	0,065
6	2,00	0,079
7	2,33	0,092
8	2,67	0,105
9	3,00	0,118
10	3,33	0,131
11	3,67	0,144
12	4,00	0,156
13	4,33	0,170
14	4,67	0,184
15	5,00	0,197
16	5,33	0,210
17	5,67	0,223
18	6,00	0,237
19	6,33	0,249
20	6,67	0,263
21	7,00	0,276
22	7,33	0,288
23	7,67	0,302
24	8,00	0,315
25	8,33	0,328
26	8,67	0,341
27	9,00	0,354
28	9,33	0,367
29	9,67	0,380
31	10,23	0,407
32	10,67	0,420
34	11,33	0,446
36	12,00	0,472
38	12,67	0,494
40	13,33	0,520
45	15,00	0,591



© 2023 by SPIGGLE & THEIS Medizintechnik GmbH

Änderungen und Irrtümer – einschließlich Bilder - vorbehalten.
Produktsortiment kann pro Land abweichen.

Modifications and errors – including pictures – reserved.
Product range might vary per country.



Burghof 14 · 51491 Overath · Germany
Phone: +49 2206 90 81 - 0
Fax: +49 2206 90 81 - 13
info@spiggle-theis.com
www.spiggle-theis.com